

Godox

LED聚光灯
Focusing LED Light

S30



说明书
Instruction Manual

深圳市神牛摄影器材有限公司

地址: 深圳市宝安区福海街道塘尾社区澜川工业区厂房2栋

电话: 0755-29609320(8062) 传真: 0755-25723423 邮箱: godox@godox.com

GODOX Photo Equipment Co., Ltd.

Address: Building 2, Yaochuan Industrial Zone, Tangwei Community, Fuhai Street, Bao'an District,

Shenzhen, China Tel: +86-755-29609320(8062) Fax: +86-755-25723423 E-mail: godox@godox.com

godox.com

Made in China



前言

感谢您购买神牛产品!

S30 LED聚光灯光源稳定, 显色性佳, 功能强大, 适用于静物拍摄、人像拍摄、采访布光以及视频拍摄等。可以精细调节亮度, 附件丰富, 操作简便。

产品具有以下亮点:

- 专门设计镜片, 光效柔和, 中心、边缘光效输出均匀, 得到更佳拍摄效果
- 焦距、亮度(10%-100%)可调, 能看到投影的硬度、大小、边缘对比度的变化
- 配合丰富附件, 精确控光, 打造更多创意光效
- 5V/7.4V/15V三种供电方式, 小巧轻便, 为各类场景提供可移动的光源
- 大液晶屏高清显示, 参数自动保存

警告

- ⚠ 请勿私自拆卸产品, 如产品出现故障须由本公司或授权的维修人员进行检查维修。
- ⚠ 请保持干燥: 请勿用湿手接触产品, 亦不可将产品浸入水中或暴露于雨中, 请勿将摄影灯放置在高温、高湿的地方。
- ⚠ 请勿让儿童接触本产品。
- ⚠ 摄影灯采用电源插头做为断接装置, 应保持随时便于操作。
- ⚠ 在不使用时, 请断开电源。
- ⚠ 此机有温度保护功能, 当温度过高时进入保护状态, 当温度降低后恢复正常。

部件



操作说明

1、开始使用摄影灯

- 有三种供电方式：



- 1、使用适配器(15V/4A)
- 2、使用锂电池座供电(需另购索尼7.4V锂电池)。
- 3、使用USB线连接充电宝(5V/2A)供电。

- 长按ON/OFF按钮，摄影灯开始发光。
- LCD显示主机当前信息。

备注：15V供电时，LED灯的功率默认为30W。7.4V/5V供电时，LED灯的功率默认为10W。

2、亮度调节

- 在常态时，旋转主机上的调节旋钮可对亮度进行调整。
- 可调节亮度范围：10%~100%。

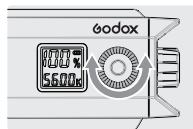

3、LED对焦距离调节

- 选择LED对焦距离旋钮，逆时针旋转到底，散光面积最大；顺时针旋转到底，散光面积最小。

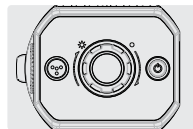

4、方向调节支架

- 方向调节支架可以实现340度旋转。
- 多次旋转支架后，出现支架松动时，可以使用标配螺丝扳手固定好。

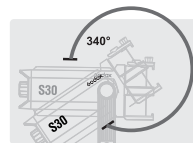

- 备注：1、使用充电宝供电时如果电流低于2A，开机LED灯会自动熄灭。
2、风扇启动温度，大于40摄氏度启动风扇1，大于45摄氏度启动风扇2。
3、温度大于70摄氏度会自动关闭LED灯。

标配物品

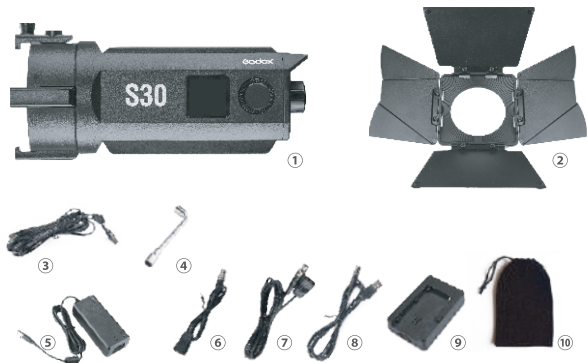

- 1、灯体
- 2、八叶挡光板
- 3、5米电源线
- 4、扳手
- 5、适配器
- 6、50cm D口线
- 7、180cm D口线
- 8、USB线
- 9、锂电池座
- 10、便携袋

产品参数

LED聚光灯	S30						
DC电源供电	适配器供电: 15V/4A	功率: 30W					
	锂电池供电(Sony NP-F970/F950/F930): 7.4V	功率: 10W					
	USB线连接充电宝供电: 5V/2A	功率: 10W					
色温	5600K ± 150K						
15V/4A适配器供电 100%光照度(LUX) (暗室, 1M距离)	聚光(中心区)≈	11300					
	散光(中心区)≈	2800					
Lux流明(≈)	距离(M)	0.5	1	2	3	4	5
	聚光(Lux)	40000	11300	3000	1300	740	480
	散光(Lux)	11000	2800	750	350	210	145
显色指数	≥96						
R9	≥95						
TLCI(Qa)	≥96						
调光范围	10%~100%						
照射角度	6度 ~ 55度						
工作环境温度	-10℃~50℃						
LED灯珠安全温度	≤70℃						
产品尺寸	215x108x100 mm						
净重	907g						

*设计和规格如有变更, 恕不另行通知。

可选购附件

可搭配以下摄影附件使用, 以获得最佳的拍摄效果和使用体验:



SA-P投影器
(包含SA-01 85mm镜头)



SA-01
85mm镜头



SA-02
60mm广角镜头



SA-03
150mm长焦镜头



SA-05
减光纱网



SA-06
可调光阑



SA-07
挡光片

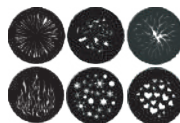

SA-09
投影片

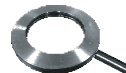

SA-10
投影片座



SA-11C(色彩效果组)
SA-11T(色温调整组)
色片

附件安装

如何安装投影器(需另购)&八叶挡光板

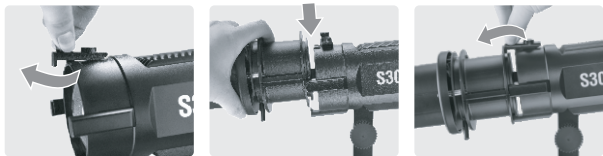

- 1、先把灯头上的扣手柱往左或右转下。
- 2、将投影器或八叶挡光板沿卡口放进灯头卡槽中。
- 3、再将扣手柱转回原本位置。

附件光效

投影器：可精确控制光斑的大小和效果，配合其他附件打造更多创意光效



八叶挡光板：可根据需要精确控光，对光束塑形

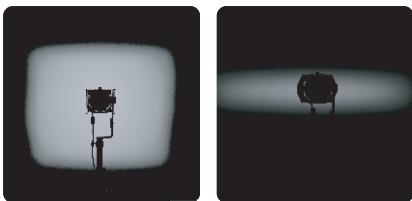

挡光片：改变投影的形状，控制光形的透视感



投影片：根据不同风格和场景投影出不同图案



减光纱网：能减弱光效及控制明暗过渡



可调光阑：在不移动灯身的情况下控制光斑大小



Foreword:

Thank you for purchasing this Godox Product!

S30 Focusing LED Light is excellent for product shooting, photojournalistic and video recording, etc. It creates stable light resource and even illumination for photography. This light's brightness can be precisely adjusted with easy operation.

Features:

- With specially designed lens to gain soft and even light effect from center to edge
- Adjustable focusing range and light brightness enable you to observe the variation of shadow's hardness, dimension and edge contrast
- Precisely control the light and achieve more creative light effects when use in combination with abundant accessories
- Three ways of power supply (5V/7.4V/15V) offer great convenience, portability and wide application
- Large-sized LCD panel. Settings auto saved

⚠ Warning

- ⚠ Do not disassemble or modify. Should the product break down, send the defective back to the authorized service center for inspection and maintenance.
- ⚠ Keep dry. Do not handle with wet hands, immerse in water, or expose to rain. Do not place in high temperature or high humidity conditions.
- ⚠ Keep out of reach of children.
- ⚠ As this product adopts make and break device, please keep it easy to be used.
- ⚠ Disconnect from the power supply when it will not be used for an extended period.
- ⚠ If this product overheats, it will cease operation and resume working after cooling down. This is due to the built-in overtemperature protection.

Parts

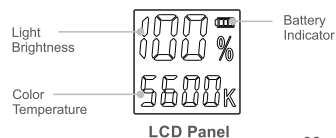

01. Lens
02. LCD Panel
03. Select Dial for Light Brightness
04. Power Switch
05. Select Dial for Focal Length
06. DC Power Socket
07. Direction Adjusting Bracket
08. Fixing Knob
09. Accessory Latch

Operation

Using the Video Light

- There are three ways for power supply:



1. Power supplied by DC adapter(15V/4A).
2. Power supplied by Li-ion battery (Sony NP-F970/F950/F930) (7.4V).
3. Power supplied by power bank with an USB cable (5V/2A).

- Long press the ON/OFF Power Switch, the video light begins to giving out light.
- LCD panel shows the information.

Note: The power of S30 is 30W when power supplied by 15V/4A DC adapter or 10W when power supplied by li-ion battery (Sony NP-F970/F950/F930) or power bank (5V/2A).

Light Brightness Adjustment

- Turn the select dial to adjust the light brightness.
- The light brightness adjustable range is at 10%~100%.



Focal Length Adjustment

When turning the Select Dial for Focal Length counterclockwise to the end, the lighting coverage is the biggest; when turning the Select Dial for Focal Length clockwise to the end, the lighting coverage is the smallest.

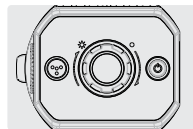

Direction Adjusting Bracket

- This bracket can be rotated up by 340°.
- If the bracket is not tight enough after repetitive rotation, please use the included wrench to fix it.

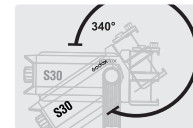

Note: 1. The LED spotlight will auto power off once powered on if the portable charger's current is lower than 2A.
 2. Fan start temperature: Fan 1 will start if the temperature is over 40°C and fan 2 will start if over 45°C.
 3. The LED spotlight will auto power off if the temperature is over 70°C.

Included Items

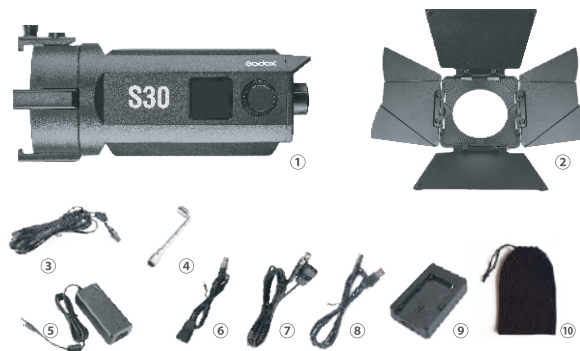

1. Light Body
2. Barndoor Set
3. 5-meter Power Cord
4. Wrench
5. Adapter
6. 50cm Cable
7. 180cm Cable
8. USB Cable
9. Lithium Battery Box
10. Portable Bag

Technical Data:

Focusing LED Light	S30							
Power Supply Options	DC adapter:15V/4A				Power: 30W			
	Li-ion battery(Sony NP-F970/F950/F930): 7.4V				Power: 10W			
	Power bank with an USB cable: 5V/2A				Power: 10W			
Color Temperature	5600K±150K							
15V/4A Adapter	Spot (Central Area)≈11300							
100% Illuminance(LUX) (1m,dark room)	Flood (Central Area)≈2800							
Lux(≈)	Distance(M)	0.5	1	2	3	4	5	
	Spot(Lux)	40000	11300	3000	1300	740	480	
	Flood(Lux)	11000	2800	750	350	210	145	
Color Rendering Index	≥96							
R9	≥95							
TLCI(Qa)	≥96							
Light Brightness Range	10%~100%							
Beam Angle	6° to 55°							
Operation Temperature	-10°C~50°C							
Safe Temperature	≤70°C							
Dimension	215x108x100 mm							
Net Weight	907g							

* Product design and specifications are subject to change without notice.

Separately Sold Accessories

The product can be used in combination with the following accessories sold separately, so as to achieve best photography effects.



SA-P
Projection Attachment
(included a SA-01 85mm Lens)



SA-01
85mm Lens



SA-02
60mm Wide-angle
Lens



SA-03
150mm Telephoto
Lens



SA-05
Scrim Set



SA-06
Iris Diaphragm



SA-07
Framing Shutter

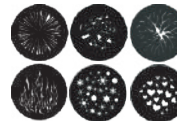

SA-09
GOBO Set



SA-10
GOBO Holder



SA-11C(Color effects set)
SA-11T(Color temperature
adjustment set)
Color Filter

Installation of Accessories

How to Install Projection Attachment(separately sold) & Barndoor Set

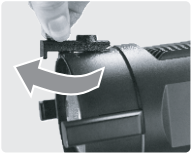

1. Move the Accessory Latch aside.

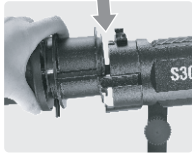

2. Put the projection attachment or barndoor set into the slot of the LED light head.

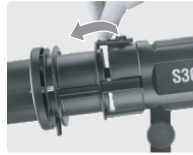

3. Rotate the Accessory Latch to the original place to tighten it.

Effects of Accessories

Projection attachment: giving the ability to project a controlled beam of light, with three options of the lens.



Barndoor set: to precisely control and shape the light beam as required



Framing shutter: using framing shutter blades to form triangles, squares, rectangles, trapezoids and other shapes

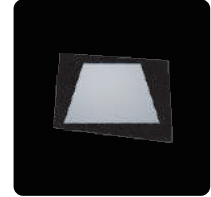

GOBO set: by inserting the Gobo into the projection attachment slot, different patterns can be projected to form various background

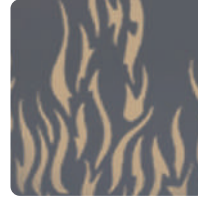

Scrim set: used to reduce the light intensity and control the light graduation



Iris Diaphragm: to control the range of light beam while not moving the light body



FCC Statement

This device complies with part 15 of the FCC Rules. Operation is subject to the following two conditions: (1) This device may not cause harmful interference, and (2) this device must accept any interference received, including interference that may cause undesired operation.

Note: This equipment has been tested and found to comply with the limits for a Class B digital device, pursuant to part 15 of the FCC Rules. These limits are designed to provide reasonable protection against harmful interference in a residential installation. This equipment generates uses and can radiate radio frequency energy and, if not installed and used in accordance with the instructions, may cause harmful interference to radio communications. However, there is no guarantee that interference will not occur in a particular installation. If this equipment does cause harmful interference to radio or television reception, which can be determined by turning the equipment off and on, the user is encouraged to try to correct the interference by one or more of the following measures:

- Reorient or relocate the receiving antenna.
- Increase the separation between the equipment and receiver.
- Connect the equipment into an outlet on a circuit different from that to which the receiver is connected.
- Consult the dealer or an experienced radio/TV technician for help.

Declaration of Conformity

GODOX Photo Equipment Co.,Ltd. hereby declares that this equipment are in compliance with the essential requirements and other relevant provisions of Directive 2014/30/EU. They are allowed to be used in all EU member states.

For more information of DoC, Please click this web link:

http://www.godox.com/DOC/Godox_S30_DOC.pdf

合格证
QC PASS

产品保修

尊敬的用户，本保修卡是申请保修服务的重要凭证，请您配合销售商填写并妥善保管，谢谢！

产品信息	型号	产品条码
用户信息	姓名	联系电话
	通信地址	
销售商信息	名称	
	联系电话	
	通信地址	
	销售日期	
备注		

注：此表应由销售商盖章确认。

适用产品

本文件适用于相关《产品保修信息》(见后面说明)所列产品，其他非属此范围的产品或部件(如促销品、赠品及其他出厂后附加的部件等)不在此保修承诺内。

保修期

产品及部件的相应保修期按相关的《产品保修信息》执行。保修期自产品首次购买日起算，购买日以购买产品时保修卡登记日期为准。

如何获得保修服务

要保修服务，您可直接与产品销售商或授权服务机构联系，也可拨打神牛产品售后服务电话，与我们联系，由我们的服务人员为您安排服务。申请保修时，您应提供有效的保修卡作为保修凭证，方可获得保修。如您不能提供有效的保修卡，则在我们可确认产品或部件属于保修范围的情况下，也可以为您提供保修，但这不作为我们的义务。

不适用保修的情况

如产品存在下列情况，本文件项下的保证和服务将不适用 ①产品或部件超过相应保修期；②错误或不当使用、维护或保管导致的故障或损坏，如：不当搬运；非按产品合理预期用途使用；不当插拔外接设备；跌落或外力挤压；接触或暴露于不适当温度、溶剂、酸碱、水浸或潮湿环境；③由非神牛授权机构或人员安装、修理、更改、添加或拆卸造成的故障或损坏；④产品或部件原有识别信息被修改变更或除去；⑤无有效保修卡；⑥使用非合法授权、非标准或非公开发行的软件造成的故障或损坏；⑦因不可抗力或意外事件造成的故障或损坏；⑧其他非因产品本身质量问题导致的故障或损坏。遇上述情况，您应向相关责任方寻求解决，神牛对此不承担任何责任。因非在保修期或保修范围内的部件、附件或软件导致产品不能正常使用的，不是保修范围内的故障。产品使用过程中正常的脱色，磨损和消耗，不是保修范围内的故障。

产品保修和服务支持信息

产品的保修期和服务类型按以下《产品保修信息》执行：

产品类别	选项名称	保修期(月)	保修服务类型
部件	电路板	12	客户送修
	电池	3	客户送修
	充电器、电源线，同步线等带电性能的部件。	12	客户送修
其他	如闪光管、造型灯泡、外壳、保护罩、锁紧装置、包装等。	无	无保修

神牛产品售后服务电话 0755-29609320-8062

Warranty

Dear customers, as this warranty card is an important certificate to apply for our maintenance service, please fill in the following form in coordination with the seller and safekeep it. Thank you!

Product Information	Model	Product Code Number
Customer Information	Name	Contact Number
	Address	
Seller Information	Name	
	Contact Number	
	Address	
	Date of Sale	
Note:		

Note: This form shall be sealed by the seller.

Applicable Products

The document applies to the products listed on the **Product Maintenance Information** (see below for further information). Other products or accessories (e.g. promotional items, giveaways and additional accessories attached, etc.) are not included in this warranty scope.

Warranty Period

The warranty period of products and accessories is implemented according to the relevant Product Maintenance Information. The warranty period is calculated from the day (purchase date) when the product is bought for the first time. And the purchase date is considered as the date registered on the warranty card when buying the product.

How to Get the Maintenance Service

If maintenance service is needed, you can directly contact the product distributor or authorized service institutions. You can also contact the Godox after-sale service call and we will offer you service. When applying for maintenance service, you should provide valid warranty card. If you cannot provide valid warranty card, we may offer you maintenance service once confirmed that the product or accessory is involved in the maintenance scope, but that shall not be considered as our obligation.

Inapplicable Cases

The guarantee and service offered by this document are not applicable in the following cases: ①. The product or accessory has expired its warranty period; ②. Breakage or damage caused by inappropriate usage, maintenance or preservation, such as improper packing, improper usage, improper plugging in/out external equipment, falling off or squeezing by external force, contacting or exposing to the improper temperature, solvent, acid, base, flooding and damp environments, etc; ③. Breakage or damage caused by non-authorized institution or staff in the process of installation, maintenance, alternation, addition and detachment; ④. The original identifying information of product or accessory is modified, alternated, or removed; ⑤. No valid warranty card; ⑥. Breakage or damage caused by using illegally authorized, nonstandard or non-public released software; ⑦. Breakage or damage caused by force majeure or accident; ⑧. Breakage or damage that could not be attributed to the product itself. Once met these situations above, you should seek solutions from the related responsible parties and Godox assumes no responsibility. The damage caused by parts, accessories and software that beyond the warranty period or scope is not included in our maintenance scope. The normal discoloration, abrasion and consumption are not the breakage within the maintenance scope.

Maintenance and Service Support Information

The warranty period and service types of products are implemented according to the following **Product Maintenance Information**:

Product Type	Name	Maintenance Period(month)	Warranty Service Type
Parts	Circuit Board	12	Customer sends the product to designated site
	Battery	3	Customer sends the product to designated site
	Electrical parts e.g. battery charger, power cord, sync cable, etc.	12	Customer sends the product to designated site
Other Items	Flash tube, modeling lamp, lamp body, lamp cover, locking device, package, etc.	No	Without warranty

Godox After-sale Service Call 0755-29609320-8062