

Godox

LR120 LED RING LIGHT

Instruction Manual

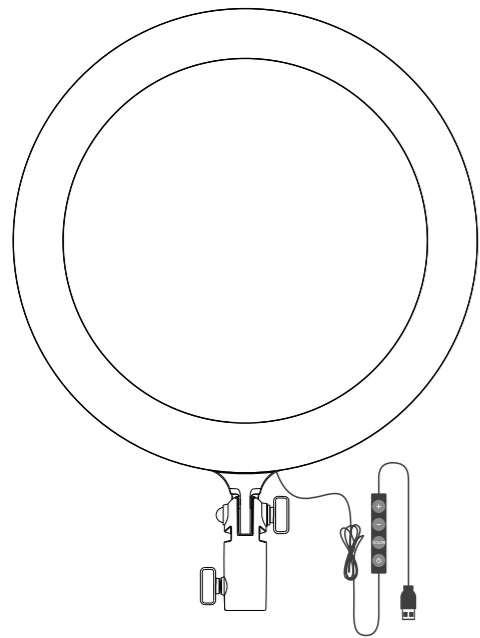

Forward

Thank you for purchasing this Godox Product!

This LED Ring Light LR120 is suitable for almost all shooting occasions, which can offer lighting for live, make up, portrait shooting, video, wedding, catchlight, etc.

Features:

- With USB cable to supply power: this light can be used in combination with smartphone adapter or power bank
- Freely adjust brightness and color temperature.
- Included a smartphone holder
- Compact and portable

Warning

- ⚠ Always keep this product dry. Do not use in rain or in damp conditions.
- ⚠ Do not disassemble. Should repairs become necessary, this product must be sent to an authorized maintenance center.
- ⚠ Keep out of reach of children.
- ⚠ As this product do not have waterproof function, please take measures of waterproof in rainy or damp environment.
- ⚠ Do not use the light in the presence of flammable gases, chemicals and other similar materials. In certain circumstance, these materials may be sensitive to the strong light emitting from this flash unit and fire or electromagnetic interference may result.

Body

01. Main Body
02. Bracket Mounting Socket
03. Heat Dissipation Slot
04. USB Power Cable
05. Power Switch
06. Color Temperature Adjusting Button COLOR
07. Brightness Increasing Button +
08. Brightness Decreasing Button -
09. 1/4" Mounting Socket

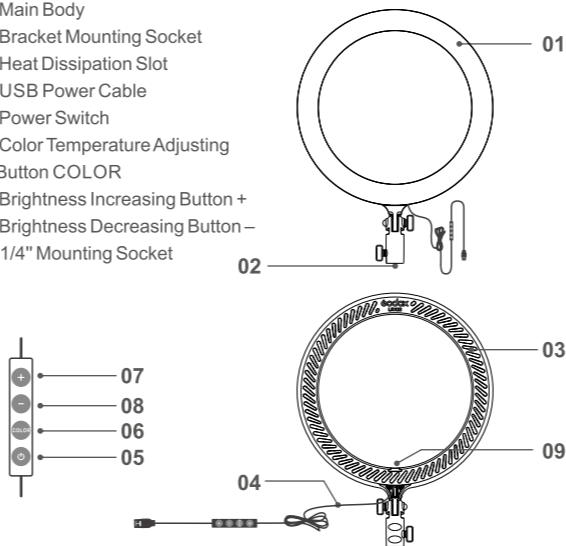

Included Items

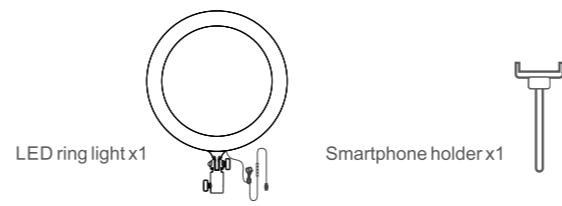

Power Management

Power Supply

Using USB DC power supply.

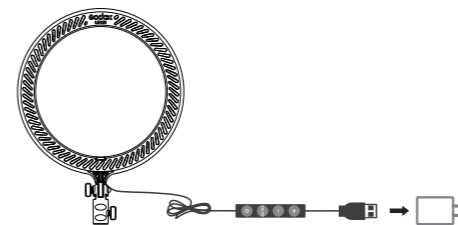

Operation

1. Before Usage

Please connect the USB power cable to the adapter which is over 5V/2A.

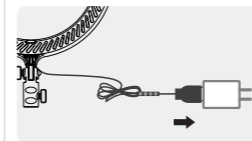

2. Power ON/OFF

Short press the power switch to power it on or off.

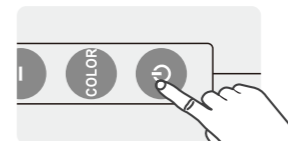

3. Light Brightness Adjustment

Press the brightness increasing button +, the brightness will be raising while pressing decreasing button - to reduce. The brightness can be adjusted from 0% to 100%.

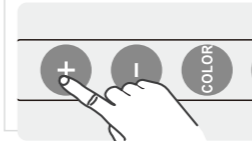

4. Color Temperature Adjustment

Press the COLOR color temperature adjusting button to adjust color temperature from 3000K to 6000K.

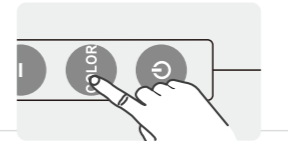

Technical Data

LED Ring Light	LR120
DC Power Supply	5V/2A
Power	Approx. 10W
Color Temperature	3000K-6000K
100% Brightness(LUX) 0.5m≈	550
Light Brightness Range	0%~100%
CRI	> 90
TLCI	> 90
LED Beads Quantity	222
Operation Temperature	-10~40°C
Dimension	305x395x35mm
Weight	Black version: 440g Pink version: 430g

Declaration of Conformity
GODOX Photo Equipment Co.,Ltd. hereby declares that this equipment are in compliance with the essential requirements and other relevant provisions of Directive 2014/30/EU. They are allowed to be used in all EU member states. For more information of DoC, Please click this web link:
http://www.godox.com/DOC/Godox_LR120_DOC.pdf

GODOX Photo Equipment Co., Ltd.

Add: Building 2, Yaochuan Industrial Zone, Tangwei Community, Fuhai Street, Bao'an District, Shenzhen, China Tel: +86-755-29609320(8062) Fax: +86-755-25723423
E-mail: godox@godox.com Made in China

godox.com

