

705-TT350C-02

Godox

迅丽TTL机顶闪光灯  
Thinklite TTL Camera Flash

TT350<sup>®</sup>C

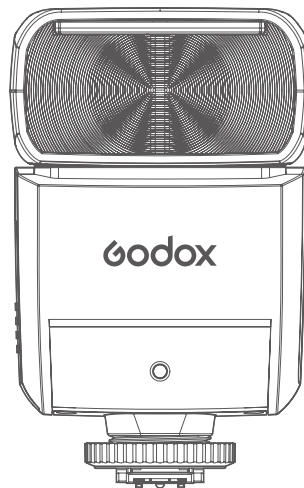

合格证  
QC PASS

说明手册

INSTRUCTION MANUAL

深圳市神牛摄影器材有限公司

地址: 深圳市宝安区福海街道塘尾社区福川工业区厂房2栋  
电话: 0755-29609320(8062) 传真: 0755-25723423 邮箱: godox@godox.com

GODOX Photo Equipment Co., Ltd.

Add: Building 2, Yaochuan Industrial Zone, Tangwei Community, Fuhai Street, Bao'an District,  
Shenzhen, China Tel: +86-755-29609320(8062) Fax: +86-755-25723423  
E-mail: godox@godox.com

godox.com

Made in China



**在使用本产品之前:**

请先仔细阅读本手册, 以确保您能安全使用。请保存好本手册以备将来查询参考。

**Before using this product:**

Please read this user manual carefully in order to ensure your safety and the proper operation of this product. Keep for future reference.

### 在使用本产品之前：

请先仔细阅读本手册，以确保您能安全使用。请保存好本手册以备将来查询参考。



### 感谢您购买神牛产品。

该型号机顶闪光灯适用于Canon系列相机，兼容TTL自动闪光。使用TTL闪光灯，您将获得更简单的拍摄体验，在光线变化复杂的情况下，可以自动获得准确的闪光曝光，拍摄轻松自如。产品特点突出表现在以下几方面：

- **GN36 (m ISO 100, @105mm)**
- **佳能相机E-TTL**  
支持TTL自动闪光，可作为无线多灯闪光系统的主控或从属单元，拍摄更简单快捷。
- **高清液晶屏**  
显示直观，操作更加简易
- **内置2.4G无线传输**  
收发一体，超远距离，创意无限
- **功能齐全，无限享用**  
支持手动和频闪闪光模式，高速同步/第二帘快门同步/闪光曝光补偿等功能
- **固件升级，兼容无忧**  
跟随原厂相机步伐，可对软件进行再升级

- ▲ 请保持干燥。
- ▲ 请勿私自拆卸产品，如产品出现故障须由本公司或授权的维修人员进行检查维修。
- ▲ 请勿让儿童接触本产品。
- ▲ 禁止拆卸、撞击、挤压或投入火中，若出现严重鼓胀，请勿继续使用。请勿放置在超过50度的高温环境中。
- ▲ 请勿将闪光灯头正对人眼闪光(特别是婴儿的眼睛)，否则可能会在短时间内造成视力障碍。
- ▲ 请勿在化学品、可燃性气体或其他特殊物质附近使用闪光灯，这些物质在特殊情况下可能对闪光灯发出的瞬间强光敏感，有可能导致火灾或电磁干扰。在这些场合下，请注意相关警告标识。
- ▲ 本产品不能防水，在雨天及潮湿环境下请注意防水。
- ▲ 若发生任何故障，请立即关闭闪光灯电源。



# 目录

01	前言
02	警告
05	部件名称
	机身
	控制面板
	液晶显示屏
	标配物品
	可选购附件
07	装卸闪光灯
07	电源管理
08	闪光模式：TTL自动闪光模式
	 闪光曝光补偿
	 高速同步
	第二帘快门同步
09	闪光模式：M手动闪光
10	闪光模式：Multi频闪闪光
11	无线闪光拍摄：无线电(2.4G)传输
	无线设置
	设置主控闪光灯的闪光模式
	设置通讯频道
	无线ID设置
	TTL:全自动无线闪光拍摄
	M:手动无线闪光拍摄
	Multi:手动无线闪光拍摄
16	其他应用
	自动辅助对焦灯
	反射闪光
	创建眼神光
	ZOOM:设置闪光覆盖范围并使用广角散光板
	电池电量低警告
	C.Fn: 设置自定义功能
19	保护功能
19	固件升级
20	规格参数
21	故障排除指南
22	兼容相机列表
22	维护保养
23	



迅丽TTL机顶闪光灯  
Thinklite TTL Camera Flash

本说明书中使用的约定

- 此使用说明书中的操作步骤假定相机和闪光灯的电源开关已开启。
- 参考页码由(第\*\*页)表示。
- 此使用说明书中使用以下警告符号：  
 该“小心”符号提供补充信息。  
 该“注意”符号表示避免出现拍摄问题的警告。

## 部件名称

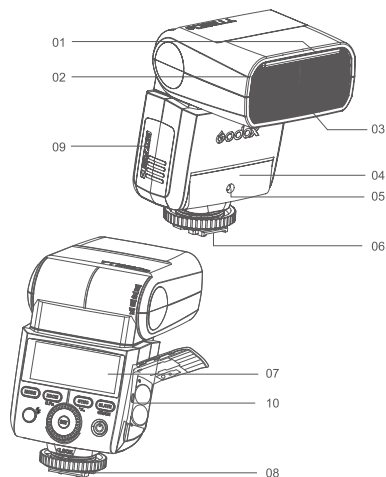

### 机身

- |             |           |
|-------------|-----------|
| 01. 眼神光板    | 06. 热靴    |
| 02. 内置广角散光板 | 07. 液晶显示屏 |
| 03. 闪光灯头    | 08. 固定旋钮  |
| 04. 光控传感器   | 09. 电池仓   |
| 05. 辅助对焦灯   | 10. USB端口 |

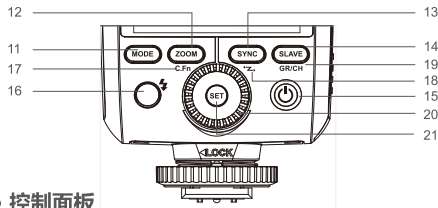

### 控制面板

- |                       |                     |
|-----------------------|---------------------|
| 11. <MODE> 闪光模式选择按钮   | (复用按钮, 长按2秒)        |
| 12. <ZOOM> ZOOM选择按钮   | 18. <+> 无线按钮        |
| 13. <SYNC> 高速同步按钮     | (复用按钮, 长按2秒)        |
| 14. <SLAVE> S1/S2光控选择 | 19. <GR/CH> 组别/频道按钮 |
| (在非无线模式)              | (复用按钮, 在无线模式)       |
| 15. <P> 电源按钮          | 20. 调节旋钮            |
| 16. <L> 试闪按钮/回电指示灯    | 21. <SET> 设置按钮      |
| 17. <C.Fn> 自定义按钮      |                     |

## ● 液晶显示屏

### (1) TTL自动闪光

Zoom : 变焦显示(第18页)

TTL : TTL自动闪光

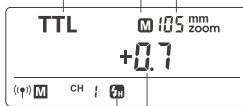

高速同步  
(第09页)

焦距(闪光覆盖/第18页)

闪光曝光补偿量

### (2) M手动闪光

M : 手动闪光

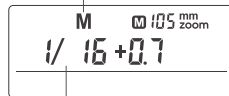

手动闪光输出

### (3) Multi频闪闪光

Multi : 多重(频闪)闪光



闪光次数

闪光频率

### (4) 无线电传输拍摄

#### ● 主控单元

闪光模式

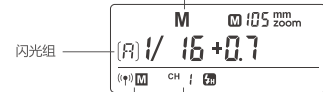

闪光组

主控

频道

#### ● 从属单元

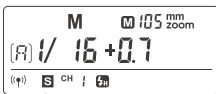

从属

## ● 标配物品

1、灯体 2、微型底座 3、保护包 4、柔光罩 5、说明书

## ● 可选购附件

可搭配本公司以下摄影附件使用, 以获得最佳的拍摄效果和使用体验:  
X1T-C无线引闪器、迷你柔光箱、反光板、蜂巢、色片、束光布等。



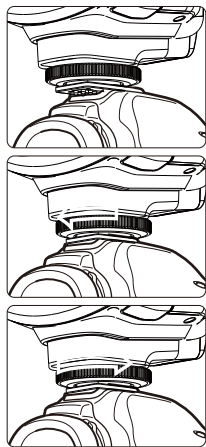

## 装卸闪光灯



- 1 安装闪光灯。
  - 滑动闪光灯固定座使其完全插入相机的热靴插座。
- 2 拧紧闪光灯。
  - 旋转固定座上的锁定旋钮, 直到锁定闪光灯。
- 3 取下闪光灯。
  - 旋转固定座上的锁定旋钮, 直到闪光灯解除锁定。

## 电源管理

使用  电源开关控制该产品的打开(长按1秒)和关闭, 长时间不使用请关闭电源。本产品设计有电源自动关闭功能。作为主控单元在长时间(约90秒)无人操作时, 闪光灯会自动关闭, 半按快门按钮或机身任意键唤醒; 作为从属单元(S1/S2、无线SLAVE)在60分钟无任何操作时, 闪光灯会进入休眠状态, 此时可按机身任意键唤醒。进入休眠状态60分钟后自动关机。

 **C.Fn** 离机使用时, 建议通过自定义功能使“自动关闭电源”无效。  
(C.Fn-ST 第19页)

## 闪光模式: TTL自动闪光模式

该闪光灯有TTL自动闪光, M手动闪光, Multi频闪光三种模式。在TTL模式下, 相机的测光系统会侦查从主体反射回来的闪光照明, 从而自动调节闪光输出量, 使主体和背景得到均衡曝光。支持曝光补偿、高速同步、第二帘快门同步等功能。

\* 按下<MODE>模式选择按钮, 三种闪光模式将会依次出现在液晶屏幕上。

### TTL模式

通过按<MODE>模式选择按钮, 将闪光灯设置为<TTL>, 可以使闪光灯进入TTL模式。

- 半按相机快门按钮进行对焦
- 在快门释放前的瞬间进行一次预闪, 闪光灯接收相机信息进行主闪光。

“Hi”提示: 当闪光功率达到最大值时, 会显示“Hi”闪烁3秒。

如果此时欠曝请调整相机的参数;

“Lo”提示: 当闪光功率达到最小值时, 会显示“Lo”闪烁3秒。

如果此时过曝请调整相机的参数。

## 闪光曝光补偿

该闪光灯可以在±3档间以1/3档为增量调节闪光曝光补偿。由于环境的需求而需要微调TTL系统时, 这个功能非常有用。

设置闪光曝光补偿:

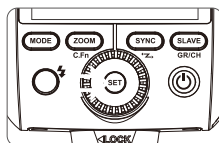

- 1 按下SET按键, 进入调整状态, 此时补偿量闪烁。

- 2 转动调节旋钮设置曝光补偿量。

- “0.3”表示1/3档, “0.7”表示2/3档。
- 要取消闪光曝光补偿, 将闪光曝光补偿量设为“0”。

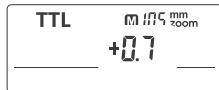

- 3 按下<SET>设置按钮, 确定闪光曝光补偿。

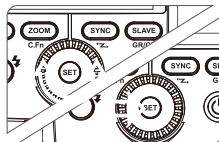

## 高速同步

使用高速同步(FP闪光)，您可以在所有的快门速度下同步使用闪光灯。高速同步模式下，使用光圈优先对人像进行填充闪光时特别方便。选择高速同步 <  > :

按 <SYNC> 按钮可开启高速同步功能

- 使用高速同步，快门速度越高，有效的闪光范围就越小。
- 在高速同步模式下，无法设置频闪闪光。
- 连续高速同步闪光15次后，闪光灯热保护功能可能会被激活。
- 尽量不使用高速同步闪光，因为高速同步闪光会缩短闪光管寿命。

## 第二帘快门同步

使用慢速快门，您可以在被摄物体后创建一条光线轨迹。在快门关闭前的瞬间闪光灯闪光。

● 按 <SYNC> 按钮直至后帘符号 <  > 显示，即开启后帘同步功能。在Multi模式和无线模式下没有后帘同步功能

## 闪光模式：M 手动闪光

您可以在1/128功率至1/1全功率间以1/3档为增量设置闪光输出。为获得正确的闪光曝光，请使用手持的闪光测光表确定所需的闪光输出。

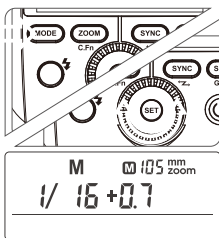

- 1 按 <MODE> 模式选择按钮，屏幕显示 <M>。
- 2 转动调节旋钮设置闪光输出功率。

在  高速同步模式，可调闪光范围1/16~1/1。

### 显示闪光输出

拍摄过程中更改闪光输出时，下表将清楚地显示光圈值是如何更改的，如1/2-0.3→1/2+0.3。您可以在增加或减少闪光输出时查看光圈值的更改规律。

例如，将闪光输出量减少至1/2、1/2-0.3或1/2-0.7，然后再将其增加至大于1/2、1/2+0.3、1/2+0.7时，将显示1/1。

减少闪光输出指数→

1/1	1/1-0.3	1/1-0.7	1/2	1/2-0.3	1/2-0.7	1/4	.....
	1/2+0.7	1/2+0.3	1/4+0.7	1/4+0.3	.....		

←增加闪光输出指数

在M模式下，可以实现  高速同步和  第二帘快门同步功能(第09页)。

## S1光控单元设置

在M手动闪光模式下，按<SLAVE>可以使用S1功能，闪光灯可作为副灯使用，创造多种照明效果，适用于手动闪光环境。它会与主闪光灯的第一次闪光同步触发闪光，效果与使用无线引闪器一致。

## S2光控单元设置

在M手动闪光模式下，按<SLAVE>可以使用S2功能，闪光灯可作为副灯使用，适用于TTL闪光环境。具有防预闪功能，使用带一次预闪功能的相机能用光控实现同步拍摄。它会与主闪光灯的第二次闪光同步触发闪光，即2次光控引闪。

- 只有在M模式下才支持S1/S2光控引闪模式。

## 闪光模式：Multi 频闪闪光

使用频闪闪光，可以发出一系列快速的闪光。它可以在一张照片上拍摄移动物体的多个图像。您可以设置闪光频率(每秒的闪光次数，以Hz表示)、闪光次数和闪光输出。

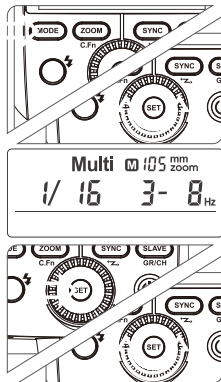

- 1 长按 <MODE> 闪光模式按钮2秒，屏幕显示 <Multi>。
- 2 转动调节旋钮设置闪光输出功率。
- 3 设置闪光频率和闪光次数。
  - 按SET按钮选择闪光频率，旋转调节旋钮设定数字。
  - 再按SET按钮选择闪光次数，旋转调节旋钮设定数字。

### 计算快门速度

在频闪闪光过程中，到闪光停止为止快门应保持开启状态。使用下面的公式计算快门速度，然后用相机进行设置。

### 闪光次数/闪光频率 = 快门速度

例如，如果闪光次数是10，闪光频率是5Hz，快门速度则至少为2秒。

- ▲ 为防止闪光灯过热并损坏，请勿执行连续10次以上的频闪闪光连拍。闪光10次后，请让闪光灯至少冷却15分钟。如果您试图执行连续10次以上的频闪闪光连拍，为防止闪光灯过热，闪光可能自动停止。如果发生了这种情况，请让闪光灯至少冷却15分钟。

- 反光很强的被摄体在暗背景前使用频闪闪光更加有效。
- 推荐使用三脚架和遥控开关。
- 频闪闪光时也可以使用“buLb”。
- 如果闪光次数显示为--，则闪光灯会连续闪光，直到快门或电池耗尽。如下表所示，闪光次数将受到限制。

### 最大频闪闪光次数

闪光输出	Hz	1	2	3	4	5	6-7	8-9	10-19	20-50	60-90
1/4		6	3	2	2	2	2	2	2	2	2
1/8		14	14	6	4	3	3	3	2	2	2
1/16		30	30	30	20	10	8	5	3	3	3
1/32		60	60	60	50	50	40	12	5	5	5
1/64		90	90	90	80	80	70	60	20	10	10
1/128		90	90	90	90	90	90	80	70	30	20

## 无线闪光拍摄：无线电(2.4G)传输

- 无线创意系统，支持创建三个从属单元组，并实现TTL自动闪光。您可以通过TTL自动闪光轻松获取多种照明效果。
- 使用主控单元按组分别设置的任何TTL自动闪光，手动闪光和频闪闪光设置都会被自动传输到从属单元。因此，在拍摄时无需操作从属单元。只需在从属单元上对每个从属组进行单独设置就可完成。
- 将此产品设置为主控单元时，可以在TTL/M/Multi/OFF四种闪光模式下工作。

TT350C使用神牛2.4G无线X系统，可以与本厂其他型号完美结合使用。

\*TT350C 作为主控单元，可控制从属单元型号：

AD600、AD600M、AD360II-C、AD360II-N、V860IIC、V850II、TT685C、TT600。

\*TT350C 作为从属单元，可受控主控单元型号：

X1T-C、V860IIC、V850II、TT685C、TT600。

- 即使有多个从属单元，主控单元也可通过无线控制控制所有的闪光灯。
- 本说明手册中，“主控单元”指安装在相机上的闪光灯，“从属单元”指通过无线控制的闪光灯。

## 1、无线设置

您可以在普通闪光和无线闪光之间切换。对于普通闪光，请务必将无线设置设为“关”。

### 主控单元设置

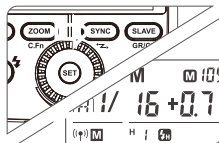

- 1 长按<SYNC>按钮2秒，直至<(P)>闪烁。旋转调节旋钮令频幕显示<(P)M>，表示主控单元。

### 从属单元设置

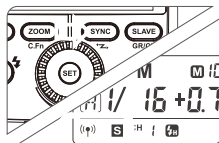

- 1 长按<SYNC>按钮2秒，直至<(P)>闪烁。旋转调节旋钮令频幕显示<(P)S>，表示从属单元。

## 2、设置组别闪光灯的闪光模式

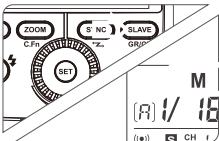

- 1 按<SLAVE>按钮选择A/B/C组别，再按<MODE>按钮选择主控单元的闪光模式可以在OFF/TTL/M之间进行切换，选择其中一种作为主控单元的闪光模式。

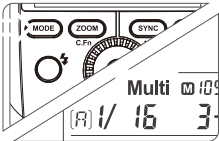

- 2 长按<MODE>按钮2秒可切换至Multi模式。

## 3、主控单元禁用

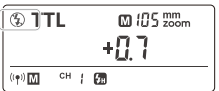

- 1 连接相机，进入相机“外接闪光灯控制”菜单；

- 2 设置“主控闪光灯闪光”选项。选择关闭，此时TT350C显示屏上的禁用符号 <  > 闪烁，表示主控单元禁用。选择打开，取消主控单元禁用。

## 4、无线ID设置

为了避免信号干扰，除了改变无线通讯频道还可以通过改变无线ID来防止干扰；主控单元和从单元设为相同的频道和无线ID即可。进入C.Fn ID,选择01-99中任意一数字无线ID打开，选OFF无线ID关闭。

## 5、设置通讯频道

如果在拍摄现场不止一个无线闪光系统，您可以通过更改通讯频道来防止信号干扰。保证主控单元和从单元设置为相同的频道编号即可。

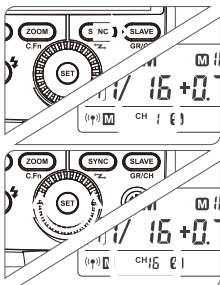

- 1 长按<SLAVE>按钮2秒直至频道值闪烁，旋转调节旋钮从1至16中选择频道。
- 2 按下<SET>设置按钮确定。

## 6、TTL: 全自动无线闪光拍摄

使用一个从属单元闪光

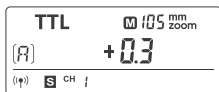
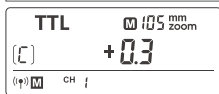

- 1 设置主控单元
- 将安装在相机上的TT350C设为主控单元。(第12页)
  - A/B/C都可独立设置为TTL。
- 2 设置从属单元
- 将要被无线控制TT350C设为从属单元。(第12页)
  - 可以选择A/B/C。
- 3 检查传输频道
- 将主控单元和从属单元的频道设为一致。(第13页)
- 4 定位相机和闪光灯
- 将其定位在 (第15页) 所示的范围内。

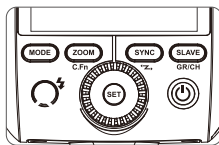

## 5 检查操作

- 按下主控闪光灯的试闪按钮 <  >。
- 从属单元闪光。如果从属单元不闪光，检查是否将其放置在操作范围内。

▲ 如果从属单元附近有wifi路由器等2.4G的设备，可能会存在干扰导致闪光灯漏闪。如有此情况发生请调节频道或者关闭2.4G设备。

## 7、M:手动无线闪光拍摄

使用手动闪光的无线（多重闪光）拍摄，可以为每个从属单元（闪光组）设定不同的闪光输出进行拍摄。在从属单元上设定所有参数。

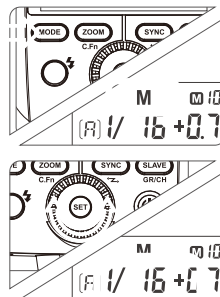

- 1 将闪光模式设为<M>。
- 按下<MODE>按钮，选择M模式。
- 2 设置闪光输出
- 旋转调节旋钮为闪光组设定闪光输出。
- 3 拍摄照片
- 各组以设定的闪光比比闪光。

## 8、Multi:手动无线闪光拍摄

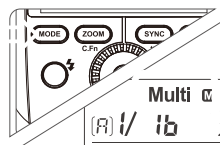

- 1 设定<Multi>频闪模式。
- 长按<MODE>按钮2秒，令屏幕显示<Multi>。如再长按<MODE>按钮2秒即退出。
- 2 闪光功率/闪光频率/闪光次数设置。
- 在A组状态下可设置闪光功率、频率、次数。设定频闪闪光设置。(第10页)



- 在B、C组只可通过<MODE>按钮控制从属单元的ON/OFF。



使具有无线电传输无线拍摄功能的闪光灯(主控/从属), 可按照与普通 TTL 自动闪光拍摄同样的方法, 轻松利用高级无线多重闪光照明进行拍摄。

基本相对位置和操作范围如图所示, 只要将主控单元设定为 <TTL> 就可以进行无线自动闪光拍摄。

#### 定位和操作范围(无线闪光拍摄的示例)

- 使用一个从属单元进行自动闪光拍摄

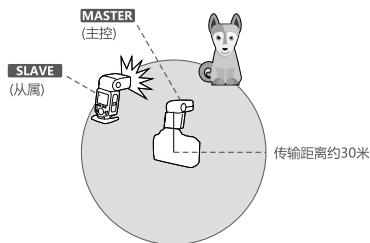

- 使用附带的微型支架定位从属单元。
- 开始拍摄前请进行测试闪光和试拍。
- 受从属单元的位置、周围环境、天气状况等影响, 传输距离可能更短。

#### 无线多重闪光拍摄

可以将从属单元分割为两个或三个组同时进行TTL自动闪光拍摄。此外, 可以为各闪光组(最多3个组)设定并用不同的闪光模式拍摄。

- 用两个从属组进行自动闪光拍摄。

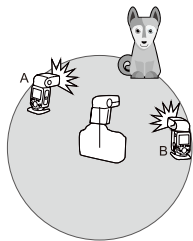

- 用三个从属组进行自动闪光拍摄。

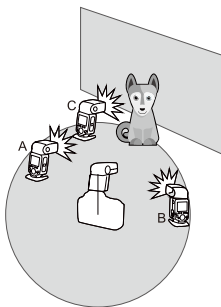

#### ⚠ 神牛2.4G无线漏闪原因及解决办法

1. 外部环境2.4G信号干扰(如无线基站、2.4Gwifi路由、蓝牙设备等)  
→ 请调节引闪器的频道CH设置(建议+10), 找到无干扰的频道来工作, 或者在工作时关闭其他2.4G设备。
2. 请确认闪光灯是否已经回电或者回电速度已经跟上连拍速度(闪光灯就绪指示灯已经亮起), 并且没有处于过热保护或者其他异常状态中  
→ 请下调闪光灯的档位, 如是TTL模式可以尝试改为M模式(TTL模式下需要预闪一次)。
3. 是否引闪器和闪光灯距离太近(距离<0.5m)  
→ 请在引闪器上打开“近距离无线模式”:  
X1系列: 按住引闪按钮不放, 然后开机, 直至指示灯闪2次。  
Xpro系列: 设置C.Fn-DIST为0-30m。
4. 是否引闪器和接收端设备在低电状态  
→ 请更换电池(引闪器电池建议使用1.5V一次性碱性电池)。

#### 其他应用

##### 自动辅助对焦灯

在低亮度或低对比度的拍摄情况下, 闪光灯内置的自动对焦辅助灯将开启, 使自动对焦更容易。当对焦困难时, 红色辅助对焦灯亮起; 当对焦准确, 辅助对焦灯自动熄灭。

如想关闭自动辅助对焦功能, 在C.Fn设置“AF”至“OFF”。

位置	有效范围
中央	0.6~4米
边缘	0.6~2.5米

## 反射闪光

通过将闪光灯头指向墙壁或天花板，闪光在照亮被摄体前被墙面反射。这可以减轻被摄物体背后的阴影，获得更自然的摄影效果。称之为反射闪光。

旋转闪光灯头来设置反射方向。

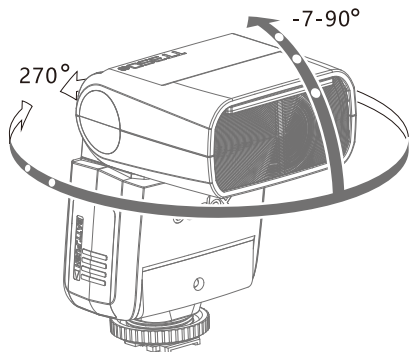

- 如果墙壁或天花板太远，反射闪光可能太弱并导致曝光不足。
- 墙壁或天花板应该是平坦的、白色的以利于高效的反射。如果反射表面不是白色的，照片将出现偏色。

## 创建眼神光

使用眼神光板，您可以在被摄体的眼睛中创建眼神光以使面部表情更加生动。

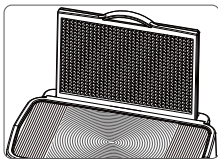

- 将闪光灯头向上旋转90°。
- 拉出广角散光板，同时弹出眼神光板。

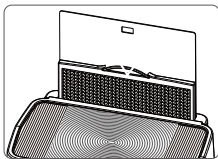

- 推入广角散光板。
  - 仅推入广角散光板。
  - 按照反射闪光中相同的步骤进行。

- 请将闪光灯头向前指然后向上旋转90度。如果左右旋转闪光灯头就不会产生眼神光。
- 要获得最好的眼神光效果，被摄体不能处于相机1.5米/4.9英尺以内。

## ZOOM：设置闪光覆盖范围并使用广角散光板

该闪光灯有两种变焦方式：自动变焦和手动变焦。可以设置闪光覆盖范围以匹配24-105毫米的镜头焦距。自动变焦时，焦距会随相机变焦镜头的改变而变化，以提供最佳闪光效果。同样，使用内置的广角散光板，闪光覆盖范围可以扩展为14毫米广角镜头。

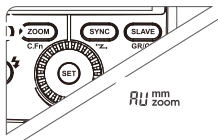

手动变焦时，按下<ZOOM>设置按钮。

- 转动调节旋钮更改闪光覆盖范围。
- 在显示< AU >状态下，将自动设置闪光覆盖范围。

- 如果手动设置闪光覆盖范围，确保其覆盖镜头焦距，这样照片就不会出现阴影边缘。
- 低电量警示时，ZOOM值将无法调整，自动固定在24mm。

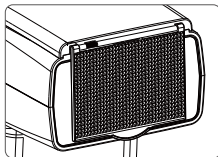

使用广角散光板

拉出广角散光板并将其置于闪光灯头上。闪光覆盖范围将扩展至14毫米。

- 同时弹出眼神光板。请推回眼神光板。

- 当拉出广角散光板，ZOOM值会固定在14mm，<ZOOM>按钮不起作用。

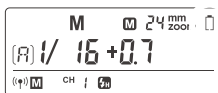

电池电量低时，电池符号< [ ] >会闪烁，此时请更换电池。

低电量警示时，ZOOM值将无法调整，自动固定在24mm。

## C.Fn: 设置自定义功能

请对照以下图表本机应用栏, 使用自定义功能来完成设置。

自定义功能符号	功能	设置符号	设置和说明
ST	自动休眠(standby)	ON	启动
		OF	关闭
AF	自动对焦辅助闪光灯	ON	启动
		OF	关闭
BL	背光控制	10秒	10秒后自动熄灭
		OF	一直熄灭
		ON	一直点亮
ID	无线ID	OFF	关闭
		01-99	选择01-99任意一个数字打开

1. 长按 < **ZOOM** > 按钮2秒,直到显示C.Fn菜单。
2. 旋转调节旋钮选择自定义功能。
3. 按 < **SET** > 设置按钮, 自定义功能编号闪烁。
4. 旋转调节旋钮设置想要的编号, 按 < **SET** > 按钮确定。
5. 按 < **ZOOM** > 退出C.Fn菜单。

## 保护功能

### 1. 热保护

- 为防止闪光灯头过热并损坏, 请勿在1/1功率时进行超过30次的快速连续闪光。30次连续闪光后, 要让闪光灯至少冷却10分钟。
- 如您在进行超过30次连续闪光后马上继续进行更多次闪光, 内部的热保护功能可能会被激活, 使充电时间变为10秒以上。如果发生这种现象, 请让闪光灯冷却约10分钟, 闪光灯便会恢复正常。
- 热保护启动后, 显示屏上  的符号会显示。

激活热保护功能的连续闪光次数:

功率	次数
1/1	30
1/2 +0.7	40
1/2 +0.3	50
1/2	60
1/4(+0.3,+0.7)	100
1/8(+0.3,+0.7)	200
1/16(+0.3,+0.7)	300
1/32(+0.3,+0.7)	500
1/64(+0.3,+0.7)	1000
1/128(+0.3,+0.7)	

高速同步模式下, 激活热保护功能的连续闪光次数:

功率	次数
1/1	15
1/2(+0.3,+0.7);	20
1/4(+0.3,+0.7)	30
1/8(+0.3,+0.7);	
1/16(+0.3,+0.7)	40

### 2. 其他保护

- 为了保证设备安全的工作, 系统时刻进行预防保护, 以下提示符号供您参考:

LCD显示	警告内容
E1	闪光灯回电系统出现问题, 无法回电引闪, 请重新开机, 如无法解决请维修
E3	闪光灯管两端电压过高, 请维修
E9	固件升级有误, 请进行正确固件升级

## 固件升级

本机通过USB插座可进行固件升级。软件最新公告及说明将会发布在官方网站上。

- 📌 注:本品出厂不配USB升级线, 请另行购买。普通的USB线可使用, 本产品USB口为Micro USB 接口。

查看版本号: 按住 < **MODE** > 按钮然后开机, 显示U-1.0, 表示1.0版本。

## 规格参数

型号	TT350C
• 类型	
兼容相机	Canon佳能相机 (参考兼容相机列表)
闪光指数 (1/1档位; 105mm焦距)	36(m ISO 100)
闪光覆盖范围	24 – 105毫米 •自动变焦(自动设置适合镜头焦距和图像尺寸的闪光覆盖范围) •手动变焦 •闪光灯头旋转/倾斜, 水平0~270°, 垂直-7°~90°(反射闪光)
闪光持续时间(t0.1)	1/350秒 - 1/20000秒
• 曝光控制	
曝光控制系统	TTL 自动闪光、手动闪光
闪光曝光补偿(FEC)	手动, 闪光包围曝光: 在±3档间以1/3档为增量调节 (可以组合使用手动闪光曝光补偿)
同步方式	高速同步(最高1/8000秒), 前帘同步, 后帘同步
频闪闪光	具备(次数: 90次; 90Hz)
• 无线闪光(无线电2.4G传输)	
无线功能	主控单元, 从属单元, 关闭
可控制从属单元组	3组: A, B, C
传输范围(约)	≤30 米
频道	16组: 1~16
• 自动对焦辅助光	
有效范围(约)	中央: 0.6 - 4米 / 边缘: 0.6-2.5米
• 电源	
AA型电池	镍氢电池(推荐)或LR6类型碱性电池*2节
回电时间	约0.1-2.2秒(松下eneloop镍氢电池, 闪光灯准备就绪, LED红色指示灯亮起)
全功率闪光次数	约210次(2500mA镍氢电池)
节能	闪光灯在无人操作90秒左右将会自动关闭电源。 设置为从属单元时60分钟进入休眠状态。
• 同步触发方式	热靴, 光控
• 尺寸	
体积	140*62*38 mm
净重(不含电池)	200g

## 故障排除指南

如果遇到问题, 请参阅此故障排除指南。

### 闪光灯不充电。

- 电池安装方向错误。  
→以正确的方向安装电池。
- 闪光灯的内置电池耗尽。  
→如果闪光灯LCD屏幕上< [ ] >显示并闪烁, 表明需要更换电池。

### 闪光灯不闪光。

- 闪光灯没有牢固地安装在相机上。  
→将闪光灯的固定座牢固地安装在相机上。
- 闪光灯和相机的电子触点变脏。  
→请清洁触点。

### 电源自动关闭。

- 当灯作为主控单元时, 90秒无操作后, 自动电源关闭功能生效。  
→半按快门按钮或机身任意按键唤醒。
- 作为从属单元在60分钟无任何操作时, 闪光灯会进入休眠状态。  
→可按机身任意按键唤醒。

### 自动变焦不工作。

- 闪光灯没有牢固地安装在相机上。  
→将闪光灯的固定座牢固地安装在相机上。

### 闪光曝光不足或过度。

- 使用高速同步。  
→使用高速同步, 有效的闪光范围会更小。确保被摄体位于显示的有效闪光范围内。
- 闪光灯使用手动曝光模式。  
→改为TTL模式或修改闪光输出功率设置。

### 相片出现暗角或者被摄物体只有局部能照亮。

- 相机镜头焦距超出闪光灯的覆盖范围。  
→请检查闪光灯当前的覆盖焦距。本产品的灯头变焦范围是画幅系统的24-105mm, 您可以尝试拉出广角闪光板, 以扩大闪光范围。

## 兼容相机列表

本机可兼容以下Canon照相机型号：

5D Mark III 80D 7D 760D 60D 600D 30D

100D 1100D Digital X



注：

1. 此表格仅列举目前已测试的相机型号，未涵盖所有Canon照相机。其他相机型号，用户可自行测试。
2. 本公司保留未来修改此表格内容的权利。

## 维护保养

- 闪光灯在工作时，如发现异常，应立即关掉电源，查明原因。
- 灯体应避免震动，平时注意表面除尘。
- 灯体稍有发热为正常现象，无特别需要时，勿连续引闪。
- 闪光灯的所有维修概由本厂指定可供原厂配件之维修部负责。
- 1年保修，消耗品如灯管等，不在1年保修范围。
- 经发现，擅自检修此闪光灯的，将取消闪光灯之一年保修期，维修需要收取相关费用。
- 如果本品出现故障或者被水淋湿，在专业人员维修后方可继续使用。
- 如有技术更改，恕不另行通知。

## Foreword

### Thank you for purchasing this product.



This TT350C camera flash applies to Canon series cameras and is compatible with TTL autoflash. With this TTL compatible flash, your shooting will become simpler. You can easily achieve a correct flash exposure even in complex light-changing environments. This camera flash features:

- GN36 (m ISO 100, @105mm).
- Fully support Canon E-TTL camera flash. Workable as Master or Slave unit in a wireless flash group.
- With built-in 2.4GHz wireless remote system to support transmitting and receiving.
- Provided multiple functions, include manual flash, multi flash, HSS (up to 1/8000s), second curtain sync, FEC, etc.
- Support with firmware upgrade.

## Warning

- ▲ Always keep this product dry. Do not use in rain or in damp conditions.
- ▲ Do not disassemble. Should repairs become necessary, this product must be sent to an authorized maintenance center.
- ▲ Keep out of reach of children.
- ▲ Stop using this product if it breaks open due to extrusion, falling or strong hit. Otherwise, electric shock may occur if you touch the electronic parts inside it.
- ▲ Do not fire the flash directly into the eyes (especially those of babies) within short distances. Otherwise visual impairment may occur.
- ▲ Do not use the flash unit in the presence of flammable gases, chemicals and other similar materials. In certain circumstance, these materials may be sensitive to the strong light emitting from this flash unit and fire or electromagnetic interference may result.
- ▲ Do not leave or store the flash unit if the ambient temperature reads over 50°C. Otherwise the electronic parts may be damaged.
- ▲ Turn off the flash unit immediately in the event of malfunction.



# Contents

25	<b>Foreword</b>
26	<b>Warning</b>
29	<b>Name of Parts</b>
	Body
	Control Panel
	LCD Panel
	What's in the Box of TT350C?
	Separately Sold Accessories
31	<b>Attaching to a Camera</b>
32	<b>Power Management</b>
32	<b>Flash Mode: TTL Autoflash</b>
	 FEC (Flash Exposure Compensation)
	 High-Speed Sync
	Second-Curtain Sync
34	<b>Flash Mode – M: Manual Flash</b>
35	<b>Flash Mode – Multi: Stroboscopic Flash</b>
36	<b>Wireless Flash Shooting: Radio (2.4G) Transmission</b>
	Wireless Settings
	Setting Master Unit's Flash Mode
	Setting the Communication Channel
	Wireless ID Settings
	TTL: Fully Automatic Wireless Flash Shooting
	M: Wireless Flash Shooting with Manual Flash
	Multi: Wireless Flash Shooting with Manual Flash
41	<b>Other Applications</b>
	Auto Focus Assist Beam
	Bounce Flash
	Creating a Catchlight
	ZOOM: Setting the Flash Coverage and Using the Wide Panel
	Low Battery Warning
43	<b>C.Fn: Setting Custom Functions</b>
44	<b>Protection Function</b>
45	<b>Firmware Upgrade</b>
45	<b>Technical Data</b>
47	<b>Troubleshooting</b>
47	<b>Compatible Camera Models</b>
48	<b>Maintenance</b>



## Thinklite TTL Camera Flash

### Conventions used in this Manual

- This manual is based on the assumption that both the camera and camera flash's power switches are powered on.
- Reference page numbers are indicated by "p.\*\*".
- The following alert symbols are used in this manual:
  -  The Caution symbol indicates a warning to prevent shooting problem.
  -  The Note symbol gives supplemental information.

## Name of Parts

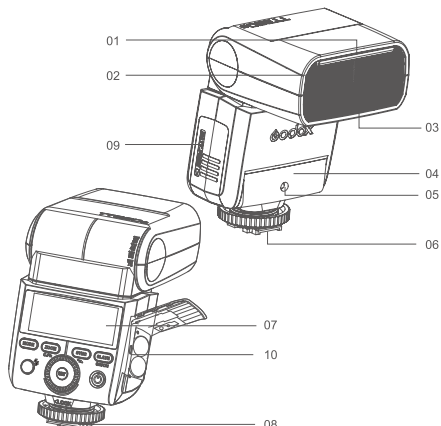

### • Body

- |                          |                         |
|--------------------------|-------------------------|
| 01. Catchlight Panel     | 06. Hotshoe             |
| 02. Built-in Wide Panel  | 07. LCD Panel           |
| 03. Flash Head           | 08. Lock Ring           |
| 04. Optic Control Sensor | 09. Battery Compartment |
| 05. Focus Assist Beam    | 10. USB Port            |

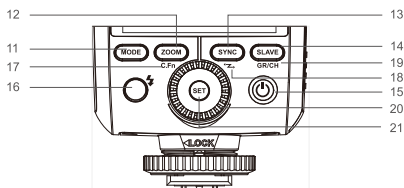

### • Control Panel

- |  |   |
|--|---|
| 11. <MODE> Mode Selection Button   | press for 2 seconds)  |
| 12. <ZOOM> Zoom Selection Button   |   |
| 13. <SYNC> High-Speed Sync Button  | 18. <Z> Wireless Selection Button (reusable button, long press for 2 seconds) |
| 14. <SLAVE> S1/S2 Optic Slave Triggering Selection Button (in non-wireless mode) | 19. <GR/CH> Group/Channel Button (reusable button, in wireless mode)          |
| 15. <P> Power Switch   |   |
| 16. <F> Test Dial / Flash Ready Indicator.                                       | 20. Select Dial   |
| 17. <C.Fn> Custom Function Setting Button (reusable button, long                 | 21. <SET> Set Button  |

### • LCD Panel

#### (1) TTL Autoflash

Zoom : zoom display (Page 42)      Focus length (Page 42)

TTL : TTL autofocus

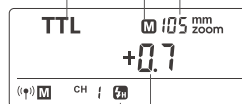

Flash exposure compensation (Page 33)

Flash exposure compensation amount

#### (2) M Manual Flash

M : Manual flash

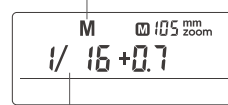

Manual flash output

#### (3) Multi Flash

Multi : Stroboscopic flash

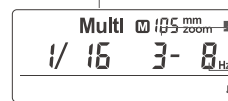

Number of flashes

Flash frequency

#### (4) Radio Transmission Shooting

##### • Master Unit

Flash mode

Firing group

Master

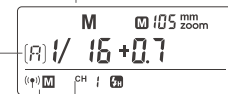

Channel

##### • Slave Unit

Slave

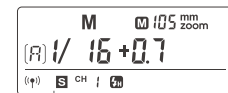



## • What's in the Box of TT350C?

1. Flash unit
2. Mini stand
3. Protection case
4. Diffuser
5. Instruction manual

## • Separately Sold Accessories

The product can be used in combination with the following accessories sold separately, so as to achieve best photography effects: X1T-C wireless flash trigger, Mini softbox, White & Silver reflector, Honeycomb, Color gels, Snoot, etc.



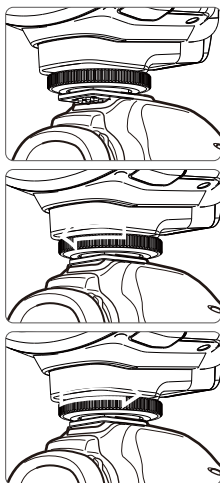

## Attaching to a Camera



- 1 Attach the Camera Flash.
  - Slip the camera flash's mounting foot into the camera's hotshoe all the way.
- 2 Secure the Camera Flash.
  - Rotate the lock ring on the mounting foot until it locks up.
- 3 Detach the Camera Flash.
  - Rotate the lock ring on the mounting foot until it is loosened.

## Power Management

Use  Power Switch to power the flash unit on (Long press the button for one second) or off. Turn off if it will not be used for an extended period of time. Setting as a master flash, it will turn the power off automatically after a certain period (approx. 90 seconds) of idle use. Pressing the camera shutter halfway or pressing any flash button will wake up the flash unit. Setting as a slave flash, it will enter sleep mode after a certain period (adjustable, 60 minutes by default) of idle use. Pressing any flash button will wake it up.

 **C.Fn** Disabling Auto Power Off function is recommended when the flash is used off camera. (C.Fn-ST, Page 43)

## Flash Mode: TTL Autoflash

This flash has three flash modes: TTL, Manual (M), and Multi (Stroboscopic). In TTL mode, the camera and the flash will work together to calculate the correct exposure for the subject and the background. In this mode, multiple TTL functions are available: FEC, HSS, second curtain sync, etc.

\* Press **<MODE>** Mode Selection Button and three flash modes will display on the LCD panel one by one with each pressing.

### TTL Mode

Press **<MODE>** Mode Selection Button to enter TTL mode. The LCD panel will display **<TTL>**.

- Press the camera release button halfway to focus.
- When the shutter button is fully pressed, the flash will fire a pre-flash that the camera will use to calculate exposure and flash output the instant before the photo is taken.

Display **"HI"**: When the flash output value is up to the maximum value, **"HI"** will be displayed and blinking for 3 seconds. Adjust the camera's parameters if underexposure appears.

Display **"Lo"**: When the flash output value is up to the minimum value, **"Lo"** will be displayed and blinking for 3 seconds. Adjust the camera's parameters if overexposure appears.

## **FEC: Flash Exposure Compensation**

With FEC function, this flash can adjust from -3 to +3 in 1/3rd stops. It is useful in situations where minor adjusting of the TTL system is needed based on the environment.

### Setting FEC:

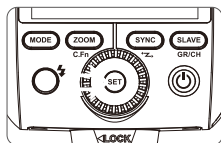

- 1 Press the **SET** Button and the flash exposure compensation amount will be highlighted on the LCD panel.

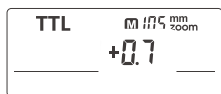

- 2 Turn the Select Dial to set the amount.

- "0.3" means 1/3 step, "0.7" means 2/3 step.
- To cancel the flash exposure compensation, set the amount to "+0".

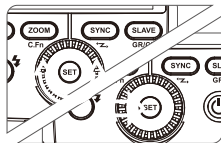

- 3 Press <**SET**> button again to confirm the setting.

## M: Manual Flash

The flash output is adjustable from 1/1 full power to 1/128th power in 1/3rd stop increments. To obtain a correct flash exposure, use a hand-held flash meter to determine the required flash output.

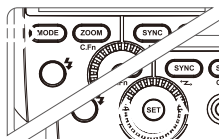

- 1 Press <**MODE**> button so that <**M**> is displayed.

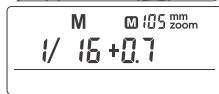

- 2 Turn the Select Dial to choose a desired flash output amount.

In  high-speed sync mode, the adjustable flash range is 1/16-1/1.

### Flash Output Range

The following table makes it easier to see how the stop changes in terms of f/stop when you increase or decrease the flash output. For example, when you decrease the flash output to 1/2, 1/2-0.3, or 1/2-0.7, and then increase the flash output to more than 1/2, 1/2+0.3, 1/2+0.7, and 1/1 will be displayed.

Figures displayed when reducing flash output level→

1/1	1/1-0.3	1/1-0.7	1/2	1/2-0.3	1/2-0.7	1/4	.....
	1/2+0.7	1/2+0.3		1/4+0.7	1/4+0.3		.....

←Figures displayed when increasing flash output level

In the **M** mode,  high-speed sync and second curtain sync functions can be achieved.

### Optical S1 Secondary Unit Setting

In M manual flash mode, press the <**SLAVE**> button so that this flash can function as an optic S1 secondary flash with optic sensor. With this function, the flash will fire synchronously when the main flash fires, the same effect as that by the use of radio triggers. This helps create multiple lighting effects.

### Optical S2 Secondary Unit Setting

Press the <**SLAVE**> button so that this flash can also function as an optic S2 secondary flash with optic sensor in M manual flash mode. This is useful when cameras have pre-flash function. With this function, the flash will ignore a single "pre-flash" from the main flash and will only fire in response to the second, actual flash from the main unit.

- S1 and S2 optic triggering and off camera high-speed mode are only available in M manual flash mode.

## **High-Speed Sync**

High Speed Sync (FP flash) enables the flash to synchronize with all camera shutter speeds. This is convenient when you want to use aperture priority for fill-flash portraits.

Choose the < > button:

Press the <**SYNC**> button to turn on high-speed sync function.

- With high-speed sync, the faster the shutter speed, the shorter the effective flash range.
- Multi flash mode cannot be set in high-speed sync mode.
- Over-temperature protection may be activated after 15 consecutive high-speed sync flashes.
- Try to avoid using high-speed sync flash, which will cut short flash tube's lifetime.

## Second-Curtain Sync

With a slow shutter speed, you can create a light train following the subject. The flash fires right before the shutter closes.

- Press the <**SYNC**> button then the < > icon displayed on the panel. The flash will without second-curtain sync function in the Multi mode and in the wireless mode.

## Multi: Stroboscopic Flash

With stroboscopic flash, a rapid series of flashes is fired. It can be used to capture a multiple images of a moving subject in a single photograph.

You can set the firing frequency (number of flashes per sec. expressed as Hz), the number of flashes, and the flash output.

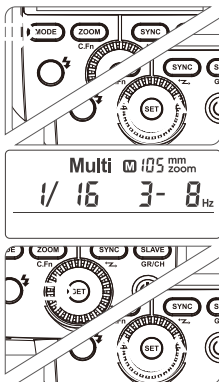

- 1 Long press the <MODE> button for 2 seconds so that <Multi> is displayed.
- 2 Turn the Select Dial to choose a desired flash output.
- 3 Set the flash frequency and flash times.
  - Press the SET Button to select the flash frequency. Turn the Select Dial to set the number.
  - Press the SET Button again to select the flash times. Turn the Select Dial to set the number.

### Calculating the Shutter Speed

During stroboscopic flash, the shutter remains open until the firing stops. Use the formula below to calculate the shutter speed and set it with the camera.

$$\text{Number of Flashes / Flash Frequency} = \text{Shutter Speed}$$

For example, if the number of flashes is 10 and the firing frequency is 5 Hz, the shutter speed should be at least 2 seconds.

- ⚠ To avoid overheating and deteriorating the flash head, do not use stroboscopic flash more than 10 times in succession. After 10 times, allow the camera flash to rest for at least 15 minutes. If you try to use the stroboscopic flash more than 10 times in succession, the firing might stop automatically to protect the flash head. If this happens, allow at least 15 minutes' rest for the camera flash.

- 📌
- Stroboscopic flash is most effective with a highly reflective subject against a dark background.
  - Using a tripod and a remote control is recommended.
  - Stroboscopic flash can be used with "buLb".
  - If the number of flashes is displayed as "—", the firing will continue until the shutter closes or the battery is exhausted. The number of flashes will be limited as shown by the following table.

### Maximum Stroboscopic Flashes:

Flash output \ Hz	1	2	3	4	5	6-7	8-9	10-19	20-50	60-90
1/4	6	3	2	2	2	2	2	2	2	2
1/8	14	14	6	4	3	3	3	2	2	2
1/16	30	30	30	20	10	8	5	3	3	3
1/32	60	60	60	50	50	40	12	5	5	5
1/64	90	90	90	80	80	70	60	20	10	10
1/128	90	90	90	90	90	90	80	70	30	20

## Wireless Flash Shooting: Radio (2.4G) Transmission

- You can set up three slave groups for TTL autoflash shooting. With TTL autoflash, you can easily create various lighting effects.
- Any flash settings for the slave units on the master flash in TTL mode will be automatically sent to the slave units. So the only thing you need to do is to set the master unit for each slave group without any operation for the slave units at all during the shooting.
- This flash can work in **TTL / M / Multi / OFF** flash modes when set as a master unit.

When using Godox 2.4G wireless X system, TT350C is perfectly compatible with other products of our company.

**As a master unit**, TT350C can control the following slave unit models: AD600, AD600M, AD360II-C, AD360II-N, V860IIC, V850II, TT685C, TT600.

**As a slave unit**, TT350C can be controlled by the following master unit models: X1T-C, V860IIC, V850II, TT685C, TT600.

- 📌
- Even with multiple slave units, the master unit can control all of them via wireless.
    - In this user manual, "master unit" refers to the camera flash on a camera and "slave unit" will be controlled by the master unit.

## 1. Wireless Settings

You can switch between normal flash and wireless flash. For normal flash shooting, be sure to set the wireless setting to OFF.

### Master Unit Setting

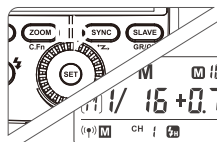

- 1 Long Press the <SYNC> button for 2 seconds so that <|> is blinking. Turn the Select Dial until the <M> is displayed on the LCD panel, which means the master unit.

### Slave Unit Setting

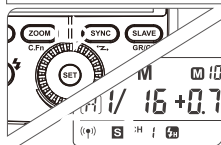

- 1 Long Press the <SYNC> button for 2 seconds so that <Ⓢ> is blinking. Turn the Select Dial until the <Ⓢ> is displayed on the LCD panel, which means the slave unit.

### 2. Setting Group Unit's Flash Mode

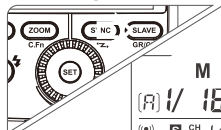

- 1 Press the <SLAVE> Button to choose the group from A/B/C. Then, press the <MODE > Button so that the master unit can work in OFF / TTL / M flash mode. Choose one of them as the flash mode of master unit.

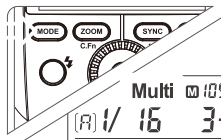

- 2 Press the <MODE> Button for 2 seconds to switch to Multi mode.

### 3. Master Unit's Flash OFF

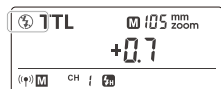

- 1 When the flash attach to camera, enter the external speedlite control on the camera menu.
- 2 Turn off the master control flash on the camera. The <Ⓢ> icon will blink on the TT350C panel, and the flash master control unit is disabled. Select turn on to cancel the master control unit disabled.

### 4. Wireless ID Settings

Change the wireless channels and wireless ID to avoid interference for it can only be triggered after the wireless IDs and channels of the master unit and the slave unit are set to the same.

Press the <MENU> button to enter C.Fn ID. Press the <SET> button to choose OFF channel expansion shutdown, and choose any figure from 01 to 99.

### 5. Setting the Communication Channel

If there are other wireless flash systems nearby, you can change the channel IDs to prevent signal interference. The channel IDs of the master unit and the slave unit(s) must be set to the same.

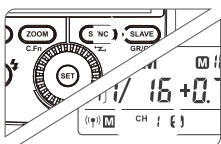

- 1 Long press the <SLAVE> Button for 2 seconds until the channel IDs is blinking. Turn the Select Dial to choose a channel ID from 1 to 16.

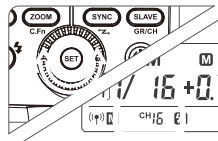

- 2 Press the <SET> button to confirm.

### 6. TTL: Fully Automatic Wireless Flash Shooting

#### Autoflash Shooting with One Slave Unit

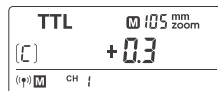

- 1 **Master Unit Setting**
  - Attach a TT350C camera flash on the camera and set it as the master unit. (Page 36)
  - A/B/C can be set as TTL mode independently.



- 2 **Slave Unit Setting**
  - Set the TT350C that to be controlled as the wireless slave unit. (Page 37)
  - The slave unit can be set as A/B/C.

- 3 **Check the communication channel**
  - If the master unit and slave unit(s) are set to a different channel, set them to the same channel. (Page 37)

#### 4 Position the camera and flashes

- Position the camera and flashes as the picture shows. (Page 40)

#### 5 Check the flash operation

- Press the master unit's Test Button <⚡>.
- Then, the slave unit will fire. If not, adjust the slave unit's angle toward the master unit and distance from the master unit.

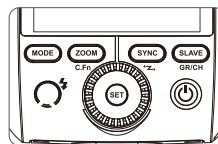

▲ The slave unit might be out of order or fire an unwanted flash due to the nearby wifi routers or other 2.4G equipments. If in this case, please adjust the flash's channel or turn off the 2.4G equipments.

## 7. M: Wireless Flash Shooting with Manual Flash

This describes wireless (multiple shooting) using manual flash. You can shoot with a different flash output setting for each slave unit (firing group). Set all parameters on the master unit.

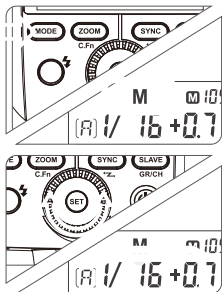

- Setting the flash mode to <M>**
  - Press the <MODE> Button to set the flash to M mode.
- Setting flash output**
  - Turn the Select Dial to set the flash output of the groups.
- Taking the picture**
  - Each group fires at the set flash ratio.

## 8. Multi: Wireless Flash Shooting with Manual Flash

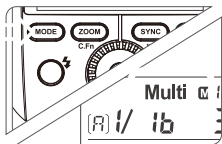

- Setting <Multi> stroboscopic flash.**
  - Long press the <MODE> button for 2 seconds so that <Multi> is displayed. Long press the <MODE> button for 2 seconds again to exit.
- Setting flash output/flash frequency/flash times.**
  - Setting the flash output/flash frequency/flash times in the A group. Setting the multi flash mode. (see Page35)



- control the ON/OFF of the slave unit by pressing the <MODE> Button.

Using a flash (master/slave) with a radio transmission wireless shooting function make it easy to shoot with advanced wireless multiple flash lighting, in the same way as TTL autoflash shooting.

The basic relative position and operation range are as shown in the picture. You can then perform wireless TTL autoflash shooting just by setting the master unit to <TTL>.

## Slave/Master Unit's Positioning and Operation Range

- Autoflash Shooting with One Slave Unit

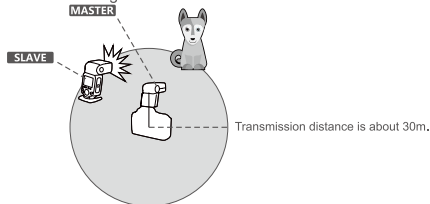

- Use the supplied mini stand to position the slave unit.
- Before shooting, perform a test flash and test shooting.
- The transmission distance might be shorter depending on the conditions such as positioning of slave units, the surrounding environment and whether conditions.

## Wireless Multiple Flash Shooting

You can divide the slave units into two or three groups and perform TTL autoflash while changing the flash ratio (factor). In addition, you can set and shoot with a different flash mode for each firing group, for up to 3 groups.

- Auto Shooting with Two Slave Groups

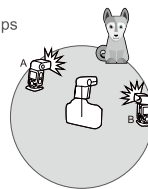

- Auto Shooting with Three Slave Groups

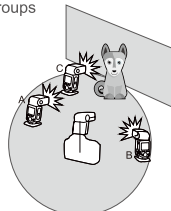

## ⚠ The Reason & Solution of Not Triggering in Godox 2.4G Wireless

- Disturbed by the 2.4G signal in outer environment (e.g. wireless base station, 2.4G wifi router, Bluetooth, etc.)**
  - To adjust the channel CH setting on the flash trigger (add 10+ channels) and use the channel which is not disturbed. Or turn off the other 2.4G equipment in working.
- Please make sure that whether the flash has finished its recycle or caught up with the continuous shooting speed or not(the flash ready indicator is lighten) and the flash is not under the state of over-heat protection or other abnormal situation.**
  - Please downgrade the flash power output. If the flash is in TTL mode, please try to change it to M mode(a preflash is needed in TTL mode).

### 3. Whether the distance between the flash trigger and the flash is too close or not

→Please turn on the "close distance wireless mode" on the flash trigger

(□ 0.5m):

X1 series: press the test button and hold on, then turning it on until the flash ready indicator blinks for 2 times.

XPro series: Set the C.Fn-DIST to 0-30m.

### 4. Whether the flash trigger and the receiver end equipment are in the low battery states or not

→Please replace the battery(the flash trigger is recommended to use 1.5V disposable alkaline battery).

## Other Applications

### Auto Focus Assist Beam

In poorly-lit or low-contrast shooting environments, the built-in auto focus assist beam will automatically light on to make it easier for autofocus. The beam will light up only when autofocus is difficult and get out as soon as the autofocus becomes correct.

If you want to turn off the auto focus assist beam, set the "AF" to "OFF" on the C.Fn settings.

Position	Effective Range
Center	0.6~4m
Periphery	0.6~2.5m

### Bounce Flash

By pointing the flash head toward a wall or ceiling, the flash will bounce off the surface before illuminating the subject. This can soften shadows behind the subject for a more natural-looking shot. This is called bounce flash.

To set the bounce direction, hold the flash head and turn it to a satisfying angle.

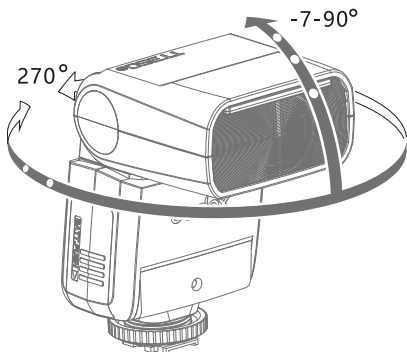

- If the wall or ceiling is too far away, the bounced flash might be too weak and result in underexposure.
- The wall or ceiling should be a plain, white color for high reflectance. If the bounce surface is not white, a color cast may appear in the picture.

### Creating a Catchlight

With the catchlight panel, you can create a catchlight in the subject's eyes to add life to the facial expression.

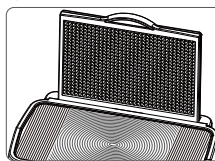

1 Point the flash head upward by 90°.

2 Pull out the wide panel. The catchlight panel will come out at the same time.

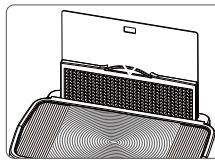

3 Push the wide panel back in.  
• Push in only the wide panel.  
• Follow the same procedures as for bounce flash.

- ▲ Point the flash head straight ahead and then upward by 90°. The catchlight will not appear if you swing the flash head left or right.
- For best catchlight effect, stay 1.5m/4.9ft away from the subject.

### ZOOM: Setting the Flash Coverage and Using the Wide Panel

The flash coverage can be set automatically or manually. It can be set to match the lens focal length from 24mm to 105mm. Also, with the built-in wide panel, the flash coverage can be expanded for 14mm wide-angle lenses.

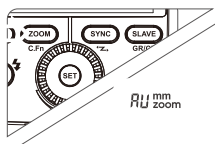

In Manual Zoom mode, press the <ZOOM> button.

- Turn the Select Dial to change the flash coverage.
- If <AU> is displayed, the flash coverage will be set automatically.

- If you set the flash coverage manually, make sure it covers the lens focal length so that the picture will not have a dark periphery.
- When the low battery indicator is displayed, the ZOOM can not be adjusted, it will constantly be 24mm.

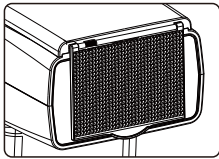

### Using the Wide Panel

Pull out the wide panel and place it over the flash head as shown. The flash coverage will then be extended to 14 mm.

- The catchlight panel will come out at the same time. Push the catchlight panel back in.

- ⚠ • When pull out the wide panel, the ZOOM will constantly be 14mm. The <ZOOM> button will not work.

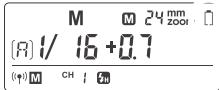

### Low Battery Warning

If the battery power is low, **⏻** > will appear and blink on the LCD panel. Please replace the battery immediately. When the low battery indicator is displayed, the ZOOM can not be adjusted, it will constantly be 24mm.

## C.Fn: Setting Custom Functions

The following table lists the available and unavailable custom functions of this flash.

C.Fn Custom Functions			
Custom Function Signs	Function	Setting No.	Settings & Description
ST	Auto sleep (standby)	ON	ON
		OF	OFF
AF	AF-assist beam	ON	ON
		OF	OFF
BL	Backlighting control	10 sec.	Off in 10 sec.
		OF	Always off
		ON	Always lighting
ID	Wireless ID	OFF	Off
		01-99	Choose any figure from 01-99

1. Press the < ZOOM > Button for 2 seconds until C.Fn menu is displayed.
2. Turn the Select Dial to select the Custom Functions.
3. Press the <SET> Button and the Setting No. blinks.
4. Turn the Select Dial to set the desired number. Pressing the <SET> Button will confirm the settings.
5. Press the <ZOOM> Button to exit.

## Protection Function

### 1. Over-Temperature Protection

- To avoid overheating and deteriorating the flash head, do not fire more than 30 continuous flashes in fast succession at 1/1 full power. After 30 continuous flashes, allow a rest time of at least 10 minutes.
- If you fire more than 30 continuous flashes and then fire more flashes in short intervals, the inner over-temperature protection function may be activated and make the recycling time over 10 seconds. If this occurs, allow a rest time of about 10 minutes, and the flash unit will then return to normal.
- When the over-temperature protection is started,  is shown on the LCD panel.

Number of flashes that will activate over-temperature protection:

Power Output Level	Number of Flashes
1/1	30
1/2 +0.7	40
1/2 +0.3	50
1/2	60
1/4(+0.3,+0.7)	100
1/8(+0.3,+0.7)	200
1/16(+0.3,+0.7)	300
1/32(+0.3,+0.7)	500
1/64(+0.3,+0.7)	1000
1/128(+0.3,+0.7)	

Number of flashes that will activate over-temperature protection in high-speed sync triggering mode:

Power Output	Times
1/1	15
1/2(+0.3,+0.7);	20
1/4(+0.3,+0.7)	30
1/8(+0.3,+0.7);	
1/16(+0.3,+0.7)	40

### 2. Other Protections

The system provides real-time protection to secure the device and your safety. The following lists prompts for your reference:

Prompts on LCD Panel	Meaning
E1	A failure occurs on the recycling system so that the flash cannot fire. Please restart the flash unit. If the problem still exists, please send this product to a maintenance center.
E3	The voltage on two outlets of the flash tube is too high. Please send this product to a maintenance center.
E9	There are some errors occurred during the upgrading process. Please using the correct firmware upgrade method.

## Firmware Upgrade

This flash supports firmware upgrade through the USB port. Update information will be released on our official website.

- USB connection line is not included in this product. The USB port is a standard Micro USB socket. Common USB connection line is applicable.

**Checking the version:** Press the <MODE> Button and the turn the flash on. Then, the firmware update version (e.g. Version 1.0 will read U-1.0) will be displayed on the LCD panel.

## Technical Data

Model	TT350C
<b>• Type</b>	
Compatible Cameras	Please reference to compatible camera models
Guide No. (1/1 output @ 105mm)	36 (m ISO 100)
Flash Coverage	24 to 105mm
	• Auto zoom (Flash coverage set automatically to match the lens focal length and image size)
	• Manual zoom
	• Swinging/tilting flash head (bounce flash): 0 to 270° horizontally and -7° to 90° vertically
Flash Duration (t0.1)	1/350 to 1/20000 seconds
<b>• Exposure Control</b>	
Exposure control system	TTL autoflash and manual flash
Flash exposure compensation (FEC)	Manual. FEB: ±3 stops in 1/3 stop increments (Manual FEC can be combined.)
Sync mode	High-speed sync (up to 1/8000 seconds), first-curtain sync, and second-curtain sync
Multi flash	Provided (up to 90 times, 90Hz)
<b>• Wireless Flash (2.4G radio transmission)</b>	
Wireless flash function	Master, Slave, Off
Controllable slave groups	3 (A, B and C)
Transmission range (approx.)	≤30m
Channels	16 (1-16)

<b>• Auto Focus Assist Beam</b>	
Effective range (approx.)	Center: 0.6~4m
	Periphery: 0.6~2.5m
<b>• Power Supply</b>	
AA batteries	Ni-MH batteries (recommended) or 2*LR6 alkaline batteries
Recycle time	Approx. 0.1-2.2 seconds (eneloop Ni-MH batteries of Panasonic), Red LED indicator will light up when the flash is ready.
Full power flashes	Approx. 210 (2500mA Ni-MH batteries)
Power saving	Power off automatically after approx. 90 seconds of idle operation. (60 minutes if set as slave)
<b>• Sync Triggering Mode</b>	Hotshoe, optic triggering
<b>• Dimensions</b>	
W x H x D	140*62*38 mm
Weight without battery	200g
2.4G Frequency Range	2413.0MHz-2438.0MHz
Max. Transmitting Power	5dbm

## Warning

Operating frequency: 2412.99MHz-2437.99MHz  
Maximum EIRP Power: -5.85dBm

## Declaration of Conformity :

GODOX Photo Equipment Co.,Ltd. hereby declares that this equipment are in compliance with the essential requirements and other relevant provisions of Directive 2014/53/EU. In accordance with Article 10(2) and Article 10(10), this product is allowed to be used in all EU member states. For more information of DoC, Please click this web link: [https://www.godox.com/DOC/Godox\\_TT350\\_Series\\_DOC.pdf](https://www.godox.com/DOC/Godox_TT350_Series_DOC.pdf). The device complies with RF specifications when the device used at 0mm from your body.



## Troubleshooting

If there is a problem, refer to this Troubleshooting Guide.

### The Camera Flash cannot be charged.

- The battery is installed in the wrong direction.  
→Install the battery in the correct direction.
- The camera flash's internal battery is exhausted.  
→If <  > appears and blinks on the LCD panel, replace the battery immediately.

### The Camera Flash does not fire.

- The camera flash is not attached securely to the camera.  
→Attach the camera's mounting foot securely to the camera.
- The electrical contacts of the Camera Flash and camera are dirty.  
→Clean the contacts.

### The power turns off by itself.

- After 90 seconds of idle operation, auto power off took effect if the flash is set as master.  
→Press the shutter button halfway or press any flash button to wake up.
- After 60 minutes of idle operation, the flash unit will enter sleep mode if it is set as slave.  
→Press any flash button to wake up.

### Auto zoom does not work.

- The camera flash is not attached securely to the camera.  
→Attach the camera flash's mounting foot to the camera.

### The flash exposure is underexposed or overexposed.

- You used high-speed sync.  
→With high-speed sync, the effective flash range will be shorter. Make sure the subject is within the effective flash range displayed.
- You used Manual Flash mode.  
→Set the flash mode to TTL or modify the flash output.

### Photos have dark corners or only parts of the target subject are illuminated.

- The focal length of lens exceeds the flash coverage.  
→Check the flash coverage you set. This flash unit has the flash coverage between 24 and 105mm, which fits medium-format cameras. Pull the wide panel out to extend the flash coverage.

## Compatible Camera Models

This flash unit can be used on the following **Canon camera models**:

5D Mark III   80D   7D   760D   60D   600D   30D

100D   1100D   Digital X

 This table only lists the tested camera models, not all Canon series cameras. For the compatibility of other camera models, a self-test is recommended. Rights to modify this table are retained.

## Maintenance

- Shut down the device immediately should abnormal operation be detected.
- Avoid sudden impacts and the product should be dedusted regularly.
- It is normal for the flash tube to be warm when in use. Avoid continuous flashes if unnecessary.
- Maintenance of the flash must be performed by our authorized maintenance department which can provide original accessories.
- This product, except consumables e.g. flash tube, is supported with a one-year warranty.
- Unauthorized service will void the warranty.
- If the product had failures or was wetted, do not use it until it is repaired by professionals.
- Changes made to the specifications or designs may not be reflected in this manual.

## FCC Statement

This device complies with part 15 of the FCC Rules. Operation is subject to the following two conditions: (1) This device may not cause harmful interference, and (2) this device must accept any interference received, including interference that may cause undesired operation.

Any Changes or modifications not expressly approved by the party responsible for compliance could void the user's authority to operate the equipment.

Note: This equipment has been tested and found to comply with the limits for a Class B digital device, pursuant to part 15 of the FCC Rules. These limits are designed to provide reasonable protection against harmful interference in a residential installation. This equipment generates uses and can radiate radio frequency energy and, if not installed and used in accordance with the instructions, may cause harmful interference to radio communications. However, there is no guarantee that interference will not occur in a particular installation. If this equipment does cause harmful interference to radio or television reception, which can be determined by turning the equipment off and on, the user is encouraged to try to correct the interference by one or more of the following measures:

- Reorient or relocate the receiving antenna.
- Increase the separation between the equipment and receiver.
- Connect the equipment into an outlet on a circuit different from that to which the receiver is connected.
- Consult the dealer or an experienced radio/TV technician for help.

The device has been evaluated to meet general RF exposure requirement.  
The device can be used in portable exposure condition without restriction.

## 产品保修

尊敬的用户，本保修卡是申请维修服务的重要凭证，请您配合销售商填写并妥善保管，谢谢！

产品信息	型号	产品条码
用户信息	姓名	联系电话
	通信地址	
销售商信息	名称	
	联系电话	
	通信地址	
	销售日期	
备注		

注：此表应由销售商盖章确认。

### 适用产品

本文件适用于相关《产品保修信息》(见后面说明)所列产品，其他非属此范围的产品或部件(如促销品、赠品及其他出厂后附加的部件等)不在此保修承诺内。

### 保修期

产品及部件的相应保修期按相关的《产品保修信息》执行。保修期自产品首次购买日起算，购买日以购买产品时保修卡登记日期为准。

### 如何获得维修服务

要维修服务，您可直接与产品销售商或授权服务机构联系，也可拨打神牛产品售后服务电话，与我们联系，由我们的服务人员为您安排服务。申请保修时，您需提供有效的保修卡作为保修凭证，方可获得保修。如您不能提供有效的保修卡，则在我们可确认产品或部件属于保修范围的情况下，也可以为您提供保修，但这不作为我们的义务。

### 不适用保修的情况

如产品存在下列情况，本文件项下的保证和服务将不适用 ①产品或部件超过相应保修期；②错误或不适当使用、维护或保管导致的故障或损坏，如：不当搬运；非按产品合理预期用途使用；不当插接外接设备；跌落或外力挤压；接触或暴露于不当温度、溶剂、酸碱、水浸或潮湿环境；③由非牛牛授权机构或人员安装、修理、更改、添加或拆卸造成的故障或损坏；④产品或部件原有识别信息被修改或删除；⑤无效保修卡；⑥使用非合法授权、非标准或非公开发行的软件造成的故障或损坏；⑦因不可抗力或意外事件造成的故障或损坏；⑧其他非因产品本身质量问题导致的故障或损坏。遇上述情况，您应向相关责任方寻求解决，神牛对此不承担任何责任。因非在保修期或保修范围内的部件、附件或软件导致产品不能正常使用的，不是保修范围内的故障。产品使用过程中正常的颜色、磨损和消耗，不属于保修范围内的故障。

### 产品保修和服务支持信息

产品的保修期和服务类型按以下《产品保修信息》执行：

产品类别	选项名称	保修期(月)	保修服务类型
部件	电路板	12	客户送修
	电池	12	客户送修
	充电器、电源线、同步线等带电性能的部件。	3	客户送修
其他	如闪光灯管、造型灯泡、外壳、保护罩、锁紧装置、包装等。	无	无保修

神牛产品售后服务电话 0755-29609320-8062

## Warranty

Dear customers, as this warranty card is an important certificate to apply for our maintenance service, please fill in the following form in coordination with the seller and safe-keep it. Thank you!

Product Information	Model	Product Code Number
Customer Information	Name	Contact Number
	Address	
Seller Information	Name	
	Contact Number	
	Address	
	Date of Sale	
Note:		

Note: This form shall be sealed by the seller.

### Applicable Products

The document applies to the products listed on the **Product Maintenance Information** (see below for further information). Other products or accessories (e.g. promotional items, giveaways and additional accessories attached, etc) are not included in this warranty scope.

### Warranty Period

The warranty period of products and accessories is implemented according to the relevant **Product Maintenance Information**. The warranty period is calculated from the day(purchase date) when the product is bought for the first time. And the purchase date is considered as the date registered on the warranty card when buying the product.

### How to Get the Maintenance Service

If maintenance service is needed, you can directly contact the product distributor or authorized service institutions. You can also contact the Godox after-sale service call and we will offer you service. When applying for maintenance service, you should provide valid warranty card. If you cannot provide valid warranty card, we may offer you maintenance service once confirmed that the product or accessory is involved in the maintenance scope, but that shall not be considered as our obligation.

### Inapplicable Cases

The guarantee and service offered by this document are not applicable in the following cases: ①. The product or accessory has expired its warranty period; ②. Breakage or damage caused by inappropriate usage, maintenance or preservation, such as improper packing, improper usage, improper plugging in/out external equipment, falling off or squeezing by external force, contacting or exposing to the improper temperature, solvent, acid, base, flooding and damp environments, etc; ③. Breakage or damage caused by non-authorized institution or staff in the process of installation, maintenance, alteration, addition and detachment; ④. The original identifying information of product or accessory is modified, alternated, or removed; ⑤. No valid warranty card; ⑥. Breakage or damage caused by using illegally authorized, nonstandard or non-public released software; ⑦. Breakage or damage caused by force majeure or accident; ⑧. Breakage or damage that could not be attributed to the product itself. Once met these situations above, you should seek solutions from the related responsible parties and Godox assumes no responsibility. The damage caused by parts, accessories and software that beyond the warranty period or scope is not included in our maintenance scope. The normal discoloration, abrasion and consumption are not the breakage within the maintenance scope.

### Maintenance and Service Support Information

The warranty period and service types of products are implemented according to the following **Product Maintenance Information**:

Product Type	Name	Maintenance Period(month)	Warranty Service Type
Parts	Circuit Board	12	Customer sends the product to designated site
	Battery	3	Customer sends the product to designated site
	Electrical parts such as battery charger, power cord, sync cable, etc.	12	Customer sends the product to designated site
Other Items	Flash tube, modeling lamp, lamp body, lamp cover, locking device, package, etc.	No	Without warranty

Godox After-sale Service Call 0755-29609320-8062