

Godox

变焦RGB LED摄影灯
Zoom RGB LED Video Light

SZ150R

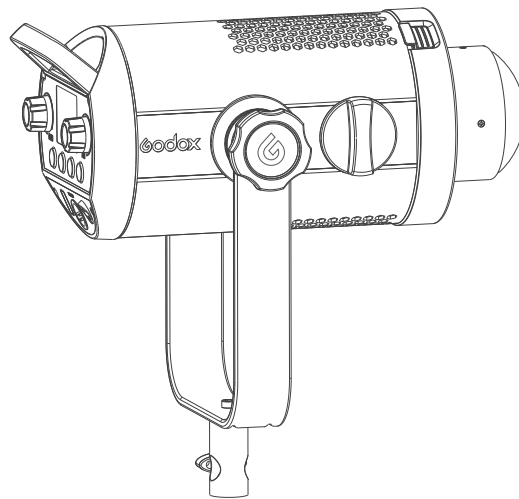

深圳市神牛摄影器材有限公司

地址: 深圳市宝安区福海街道塘尾社区耀川工业区厂房2栋
电话: 0755-29609320(8062) 传真: 0755-25723423 邮箱: godox@godox.com

GODOX Photo Equipment Co., Ltd.

Add: Building 2, Yaochuan Industrial Zone, Tangwei Community, Fuhai Street, Bao'an District,
Shenzhen, China Tel: +86-755-29609320(8062) Fax: +86-755-25723423 E-mail: godox@godox.com

godox.com

Made in China



使用手册
Instruction Manual

前言

感谢您购买神牛产品！

变焦RGB LED摄影灯SZ150R是一款多功能的RGB常亮灯，适用于任何场景：直播、自拍、静物拍摄、化妆照明、视频录播、婚纱摄影、儿童拍摄、创意拍摄等。多种遥控方式，操作便捷，应用广泛。

主要特点：

- 一灯多用，随心切换LED双色温模式、彩光模式和37种情景光效模式
- 自由调节色温、亮度、色相和色彩饱和度
- 多灯联控，手机APP/2.4G无线/DMX控制台智能遥控
- 静音模式：零噪音，无干扰
- 强光模式：功率可达最大
- 20°~65°手动调焦
- 彩屏清晰显示，简单易懂
- 优秀的的散热系统

警告

- △ 请保持干燥：请勿用湿手接触产品，亦不可将产品浸入水中或暴露于雨中。
- △ 请勿私自拆卸产品，如产品出现故障须由本公司或授权的维修人员进行检查维修。
- △ 请勿让儿童接触本产品。
- △ 本产品不能防水，在雨天及潮湿环境下请注意防水。
- △ 设备工作时会有发热现象，请小心触摸！

部件名称

• 灯体

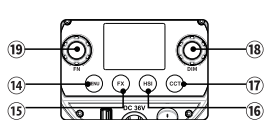
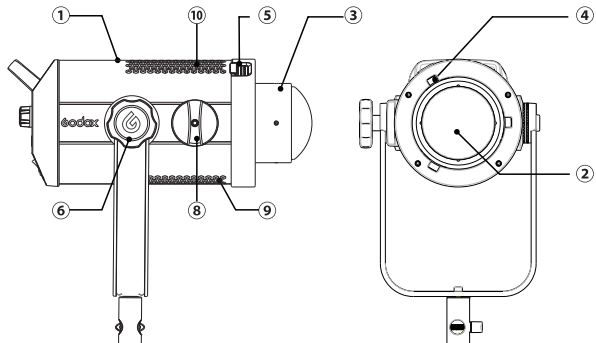

01. 灯体
02. LED灯珠
03. 灯珠保护罩
04. 保荣卡口
05. 卡口固定拨扭
06. 支架旋钮
07. U型支架
08. 调焦机械旋钮
09. 进风口
10. 散热口
11. 把手
12. 电源插座
13. 船形开关
14. MENU按键
15. FX按键
16. HSI按键
17. CCT按键
18. DIM调节旋钮
19. FN调节旋钮
20. USB升级口
21. RJ45接口 x 2

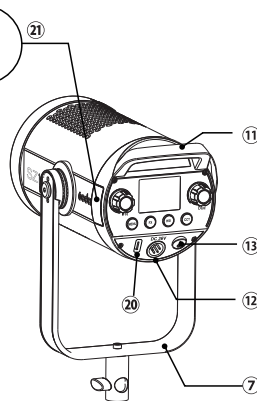

显示屏

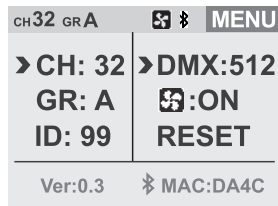

• MENU界面

1. CH通道
2. GR组别
3. 2.4G无线ID号
4. DMX通道号
5. 风扇开关
6. 蓝牙密码重置功能
7. V0.3(软件版本)
8. MAC (蓝牙号)

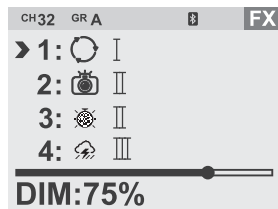

• FX界面

1. 13类37种光效不同功能显示
2. DIM: 亮度显示

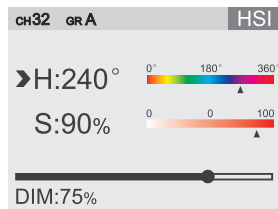

• HSI界面

1. H: 色相
2. S: 饱和度
3. DIM: 亮度显示

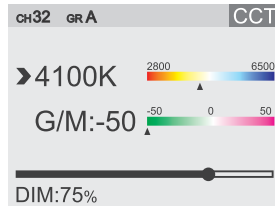

• CCT界面

1. 2800K~6500K: 色温
2. G/M: 色调
3. DIM: 亮度显示

标配物品

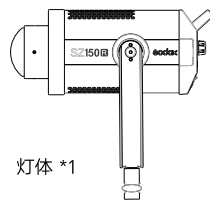

灯体 *1

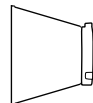

反光罩 *1



灯头保护盖 *1



钢丝绳 *1



LSA-18 适配器固定座 *1



背夹扣 *1



适配器 *1



电源线 *1



说明书 *1

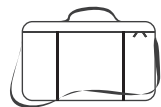

便携包 *1

可选购附件

可搭配本公司以下摄影附件使用，以获得最佳的拍摄效果和使用体验：
RC-R9遥控器、逆变器、柔光箱、反光伞、灯架、蜂巢、雷达罩、束光筒等。

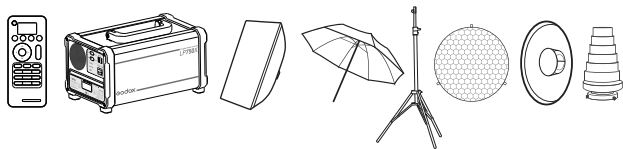

接通电源

通过电源线接通适配器，拨动LED灯上的电源开关。

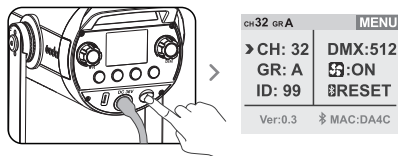

操作说明

• MENU按键

按MENU按键，LED灯进入菜单界面，可以设置CH通道(1~32)，GR组别(A/B/C/D/E/F/0-9)，ID(OFF/01~99)，DMX功能(OFF/001-512)，风扇(OFF/ON)，蓝牙(RESET)等功能。

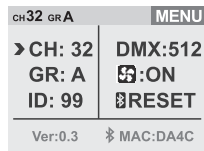

• FX按键

1. 按FX按键，LED灯进入FX界面，可以设置情景光效模式，有13类共37种，可根据需求选择。

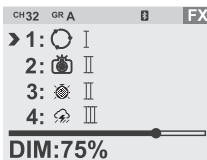

序号	显示	场景	显示 I	显示 II	显示 III
1		彩光循环	慢速	中速	快速
2		闪光灯	闪光	发布会	狗仔队
3		激光彩灯	生日会	KTV	迪斯科
4		雷闪电	间歇	频繁	持续
5		坏灯泡	间歇	频繁	持续
6		电视机	慢速	中速	快速
7		蜡烛	间歇	频繁	持续
8		火	柴火	篝火	火灾
9		烟花	短暂	连续	演出
10		警车	暴闪	频闪	快闪
11		消防车	暴闪	频闪	快闪
12		救护车	暴闪	频闪	快闪
13		SOS			

2. 在FX模式下，LED灯通过旋转FN键可以选择特效模式的类别，1~13类可选，拨动拨轮循环选取不同模式，选中后按多功能按键FN可选择当前类别中的模式：I、II、III 3种模式，按多功能按键FN循环出现；旋转DIM键调节旋钮控制亮度，亮度调节范围0%~100%，LCD显示屏将准确显示所设置的亮度。

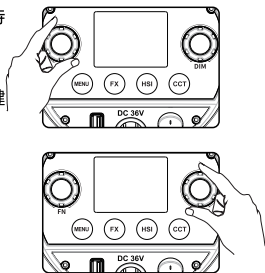

• HSI按键

按HSI按键，LED灯进入HSI界面。

1. 短按FN旋钮选择H，旋转FN旋钮可调节H色相(0°~360°)，快速旋转可进行快调。
2. 短按FN选择S，旋转FN旋钮可调节S饱和度(0~100)，快速旋转可进行快调。
3. 旋转DIM旋钮可调节亮度(0%~100%)。短按一次DIM旋钮可直接关闭亮度，再按一次可恢复关闭之前设置的亮度。

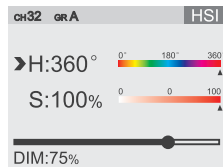

• CCT按键

按CCT按键，LED灯进入常亮色温模式界面。

1. 短按FN旋钮选择色温，再旋转FN旋钮可进行色温调节(2800K~6500K)。
2. 短按FN旋钮选择G/M，再旋转FN旋钮可进行色调调节(-50~50)。

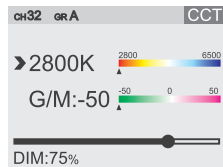

• 调焦机械旋钮

手动调节可实现照射角度从20°~65°改变。

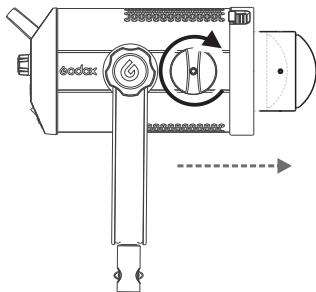

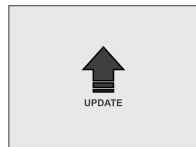
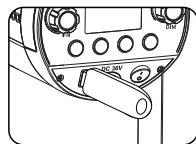

• USB升级口

1. 在官网<http://www.godox.com.cn/Downloads.html>下载新固件到U盘上。
2. 在关机的状态下，将已经存有固件的U盘插入USB升级接口。
3. 开机，LED灯自动进入升级界面。
4. 升级完后自动跳回主界面。



- 注：1. 必须官网下载新固件存放在U盘根目录，而且只有一个BIN文件。
2. USB口仅用于升级固件功能。

• 静音模式

按MENU按键进入MENU界面，旋转FN旋钮选择  图标。旋转DIM旋钮，选择ON风扇打开。选择OFF时显示屏上方出现  图标，风扇关闭，实现静音模式。

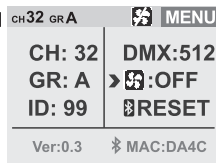

控制模式选择

1. DMX控制设置

在MENU界面选择DMX选项，可以设置DMX频道编号(OFF/001~512)。

通过RJ45口连接控制台，设置相同的频道，控制台就可以控制SZ150R LED灯的参数。

DMX:OFF

运行模式 地址码	CCT	HSI	RGBW	FX	备注
n(模式)	0-51	52-103	104-155	156-255	
n+1	DMX*(100/255) 取整数 0-100%亮度调节	DMX*(100/255) 取整数 0-100%亮度调节	0-255 取整数 0-100%亮度调节	DMX*(100/255) 取整数 0-100%亮度调节	
n+2	DMX*(最高色温-最低色温) (100/255)取整数	DMX*(360/255) 取整数 色相选择	0-255 R的值	DMX*(特效总数/255)	1、色温调节 (如:最低色温2800,最高色温6500, DMX=102,102*(6500-2800)/100/255=14(对应色温28+14=42,100=4200) 2、色相调节 (如: DMX=200: H=200*360/255=282) 3、特效: 特效总数14, DMX=160,特效号=160*14/255=8 G/M值 (-50--0--50对应取值0-50-100) 如: DMX=212,GM映射值=(212*100/255=83)-50=33
n+3	DMX*(100/255) 取整数 G/M设置	DMX*(100/255) 取整数 饱和度设置	0-255 G的值	0-85.1 86-171: II 172-255: III	
n+4			0-255 B的值		
n+5			0-255 W的值		

2. 2.4G无线控制

SZ150R LED摄影灯具备无线遥控功能，可另购遥控器RC-R9进行无线遥控，使用2.4G无线技术，可同时分别控制16组灯，32个频道，99个无线ID，抗干扰强。

按MENU按键进入MENU界面，旋转FN旋钮：

选择CH再旋转DIM旋钮，可进行频道设置(1-32)。

选择GR再旋转DIM旋钮，可进行组别设置(A/B/C/D/E/F,0-9)。

选择ID再旋转DIM旋钮，可进行ID设置(OFF/01~99)。

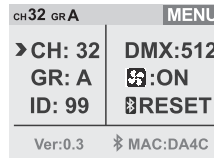

注：1、使用前请把LED灯与遥控器的频道(CH)、组别(GR)、ID设为一致。

2、LED灯在开机状态下才可以接收无线信号。

3. 蓝牙控制

3.1 按MENU按键进入MENU界面，旋转FN旋钮，选择RESET，再短按FN旋钮，实现RESET蓝牙功能。

注：首个移动设备可直接使用APP，操控灯体；更换其他移动设备时，灯体需进行RESET后，方可正常使用APP。

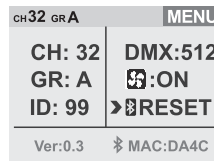

3.2 直接扫二维码即可下载“Godox Light”手机APP。(安卓和苹果系统都可以使用)



手机APP操作请打开APP里的“帮助”，里面有详细教程。

产品参数

LED灯	SZ150R
供电	AC100V-240V(50/60Hz)
功率	150W
频道	32个
组别	16组(A、B、C、D、E、F, 0-9)
色温范围	2800K ~ 6500K
调光范围	0%-100%
RGB色域	0 ~ 360 °
100%光照度(LUX) (暗室,1M距离,配标准 反光罩)	中心点 焦距扩散光状态最大 ≈19000 焦距扩散光状态最小 ≈26000
CRI	≈97
TLCI	≈96
工作环境温度	-10°C ~ 40°C
特效模式	共37种场景模式
模式	双色模式/HSI模式/场景模式
变焦	照射角度20 ° ~65 °
控制方式	手机APP/2.4G无线/DMX控制台智能遥控
静音模式	有
2.4G无线控制距离	≈50米 (另购遥控器RC-R9)
显示	彩屏
产品尺寸	336*198.6*165mm
净重量	2.65kg(不带反光罩和保护盖)

* 设计和规格如有变更，恕不另行通知。

维护保养

- 为了防止灰尘的堆积影响到产品的性能，请定时用干净的湿布轻轻擦拭产品外部。
- 1年保修，消耗品适配器，适配器电源线等配件不在此保修范围内。
- 对于不规范操作引起的机器故障不在保修范围内。
- 所有维修概由本厂指定可供原厂配件之维修部负责。
- 经发现，擅自检修本品，将取消一年保修期，维修需要收取相关费用。
- 如果本品出现故障或者被水淋湿，在专业人员维修后方可继续使用。
- 如有技术更改，恕不另行通知。

本设备包含型号核准代码为: CMIIT ID:2020DP13510, 为该产品的无线电发射模块。

Foreword

Thank you for purchasing this Godox Product!

This Zoom RGB LED Video Light SZ150R is a RGB continuous light with multiple functions. Freely switch LED bicolor mode, colorful light mode and 37 situational special effects modes. Suitable for almost all shooting occasions e.g. live, camping, portrait shooting, make up, video, wedding, children photography, etc. It's portable and easy to be operated.

Features:

- Freely switch LED bicolor mode, colorful light mode and 37 situational special effects modes
- Easy to adjust color temperature, light brightness, hue and color saturation
- Combined control by smartphone APP/2.4G wireless/DMX control
- Without noise and interference in silent mode
- Offer strong light in light burst mode
- Manually zooming from 20° to 65°
- With a colored display to clearly show the parameters
- Excellent heat dissipation system

⚠ Warning

- ⚠ Always keep this product dry. Do not use in rain or in damp conditions.
- ⚠ Do not disassemble. Should repairs become necessary, this product must be sent to an authorized maintenance center.
- ⚠ Keep out of reach of children.
- ⚠ As this product do not have waterproof function, please take measures of waterproof in rainy or damp environment.
- ⚠ As this product may heat up in working, please do not touch.

Name of Body

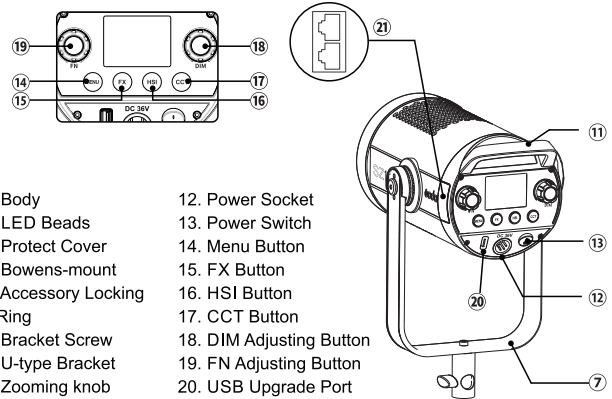
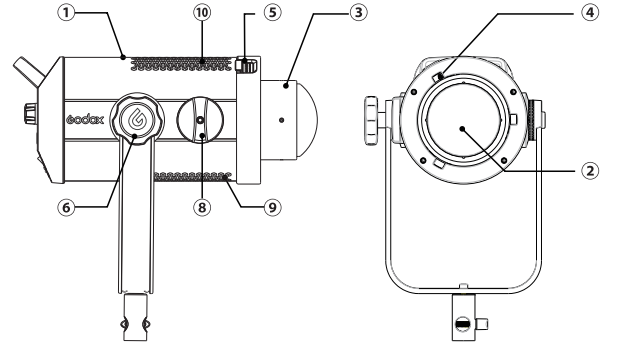

- | | |
|----------------------------|--------------------------|
| 01. Body | 12. Power Socket |
| 02. LED Beads | 13. Power Switch |
| 03. Protect Cover | 14. Menu Button |
| 04. Bowens-mount | 15. FX Button |
| 05. Accessory Locking Ring | 16. HSI Button |
| 06. Bracket Screw | 17. CCT Button |
| 07. U-type Bracket | 18. DIM Adjusting Button |
| 08. Zooming knob | 19. FN Adjusting Button |
| 09. Fan Inlet | 20. USB Upgrade Port |
| 10. Thermovent | 21. RJ45 Port x2 |
| 11. Handle | |

LCD Panel

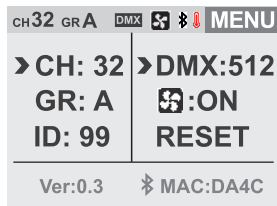

• Menu Interface

1. CH Chanel
2. GR Group
3. 2.4G Wireless ID
4. DMX Channel
5. Fan Switch
6. Bluetooth Password Reset Function
7. V0.3 (Software Version)
8. MAC(Bluetooth number)

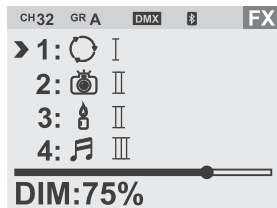

• FX Interface

1. Different Function Display from 13 categories which are divided into 39 kinds
2. DIM: Brightness Display

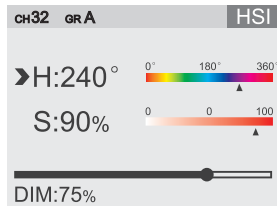

• HSI Interface

1. H: Hue
2. S: Saturation
3. DIM: Brightness Display

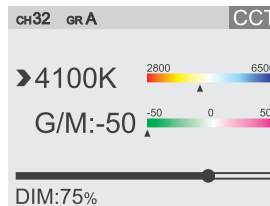

• CCT Interface

1. 2800K~6500K: Color Temperature
2. G/M: Hue
3. DIM: Brightness Display

Included Items

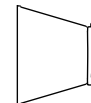
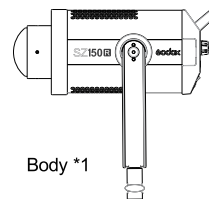

Optional Accessory

The product can be used in combination with the following optional accessories so as to achieve best photography effects:

RC-R9 Remote control, inverter, softbox, umbrella, light stand, honey comb, beauty dish, snoot, etc.

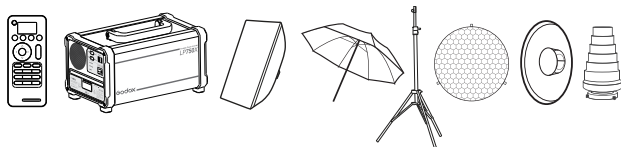

Power Supply

Connect the SZ150R to power source with adapter and power cable. Press the power switch to turn on the LED light.

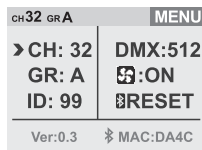
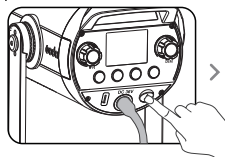

Operation

1. Setting

• Menu Button

Press the MENU button and the LED light will enter menu interface. In this interface, CH channel (1 to 32), GR group (A/B/C/D/E/F,0-9), ID (OFF/01 to 99), DMX function (OFF/001 to 512), Fan (OFF/ON) and Bluetooth can be set.

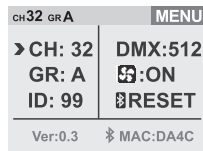

• FX Button

1. Press the FX button and the LED light will enter FX interface. In this interface, you can set 37 different special effects which are divided into 13 categories according to your demands.

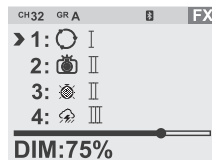

No.	Display	Situation	Display I	Display II	Display III
1		RGB cycle	Slow speed	Medium speed	Quick speed
2		Flash	Flash	Press conference	Paparazzi
3		Laser	Birthday party	KTV	Disco
4		Lightning	Discontinuous	Frequent	Sustainable
5		Broken bulb	Discontinuous	Frequent	Sustainable
6		TV	Slow speed	Medium speed	Quick speed
7		Candle	Discontinuous	Frequent	Sustainable
8		Fire	Firewood	Campfire	Fire hazard
9		Firework	Brief	Continuous	Show
10		Police car	Strong flash	Frequent flash	Quick flash
11		Fire truck	Strong flash	Frequent flash	Quick flash
12		Ambulance	Strong flash	Frequent flash	Quick flash
13		SOS			

2. In FX mode, turn the FN select dial to choose the special effect modes from 1 to 13 categories. And the modes will be selected circularly by turning the select dial. After choosing the current mode, press down the FN multifunctional select dial from I, II and III. And the modes will display circularly when keeping pressing the FN multifunctional select dial. Turn the DIM select dial to choose brightness from 0% to 100% and the brightness value will be precisely displayed on the LCD panel.

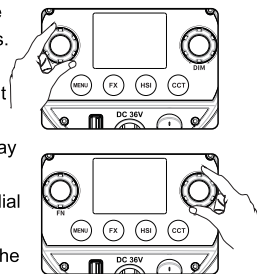

• HSI Button

Press HSI button and the LED light will enter HSI interface.

1. Short press FN button, choose H and turn the FN select dial to adjust H hue from 0° to 360°. Quickly change the parameters by turning the select dial faster.
2. Short press FN button, choose S and turn the FN select dial to adjust S saturation from 0 to 100. Quickly change the parameters by turning the select dial faster.
3. Turn the DIM select dial to adjust light brightness from 0% to 100%. Short press the DIM select dial once to turn off the brightness. Press the button again to recover the brightness set before.

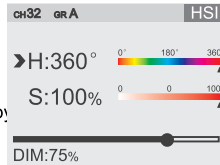

• CCT Button

Press the CCT button to enter color temperature setting interface.

1. Short press the FN button to select the color temperature. Then, turn the FN select dial to adjust color temperature from 2800K to 6500K.
2. Short press the FN button to select G/M. Then, turn the FN select dial to adjust hue from -50 to 50.

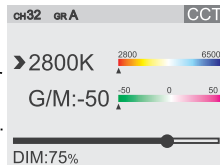

• Zooming Knob

By adjusting this knob, the beam angle can be changed from 20° to 65°.

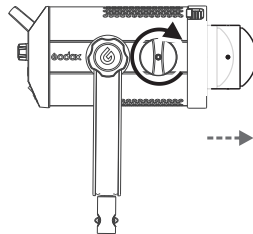

• USB Upgrade Port

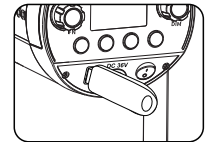

1. Download the new firmware into U disk from official website <http://www.godox.com.cn/Downloads.html>.
2. Turn off the LED light. Insert the U disk with new firmware into the USB upgrade port.
3. Turn on the LED light, and it will automatically enter the upgrading interface.
4. The LED light will automatically back to the main interface.



Note: 1. The newest firmware must be downloaded from the official website and stored in the root directory of U disk. And there can only be one BIN document.

2. The USB port can only support firmware upgrade function.

• Silent Mode

Press the Menu button to enter the MENU interface. Turn the FN select dial to choose  icon. Then, turn the DIM select dial, choose ON to boot the fan. When choosing OFF,  will be displayed and the fan will be turned off to achieve silent mode.

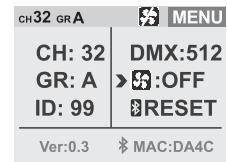

Control Mode Selection

1. DMX Control Setting

In NENU interface, choose DMX options to set DMX channels (OFF/001~512). Connect the LED light to DMX control panel by RJ45 port. Set them to the same channel, the SZ150R can be controlled by control panel.

DMX:OFF

Mode Channel	CCT	HSI	RGBW	FX	Note
n(Mode)	0-51	52-103	104-155	156-255	
n*1	DMX*(100/255) Integer 0-100% Light Brightness	DMX*(100/255) Integer 0-100% Light Brightness	0-255	DMX*(100/255) Integer 0-100% Light Brightness	
n*2	DMX*(Max. Color Temperature - Min. Color Temperature)/100/255) Integer	DMX*(360/255) Integer Hue Selection	0-255 R's Value	DMX*(Total Number of Special Light Effect/255)	1. Color Temperature Adjustment (e.g. min. color temperature 2850, min. color temperature 6500, DMX=102, 102*(6500-2800)/100/255=14) (Corresponding color temperature 28+14*42*100=4200) 2. Hue Adjustment (DMX=200, H=200*360/255=282) 3. For example: total number of special light effect *14, DMX=160, number of special light effect *14/255=8
n*3	DMX*(100/255) Integer G/M Setting	DMX*(100/255) Integer Saturation Setting	0-255 G's Value	0-85: I 86-171: II 172-255: III	G/M Adjustment: (50-0-50 Corresponding Value/60-50-100) DMX=212, GM Mapped Value=(212*100/255=83) -50=33
n*4			0-255 B's Value		
n*5			0-255 W's Value		

2. 2.4G Wireless Control

With 2.4G wireless system, SZ150R LED video light has remote grouping and control function. It is recommended to purchase RC-R9 remote control (optional) to achieve wireless control. Up to 16 groups of LED lights can be controlled. 32 channels and 99IDs are available with strong anti-interference capability.

Press the MENU button to enter MENU interface and turn the FN select dial: Select CH and turn the DIM select dial to choose channels from 1 to 32. Select GR and turn the DIM select dial to choose groups from A to E and 0 to 9. Select ID and turn the DIM select dial to choose IDs from OFF, 01 to 99.

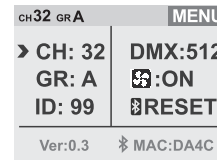

Note:

1. Please make LED light's channel, group and ID to the same as remote control's.
2. The wireless signals can only be received in the situation that the LED light is powered on.

3. Bluetooth Control

3.1 Press the MENU button to enter MENU interface. Turn the FN select dial to choose RESET. Then, short press the FN button to achieve Bluetooth function.

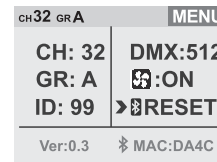

Note: the APP can be used directly on the firstly installed device. When changing to other mobile device, the light shall be reset before the normal usage of APP.

3.2 Scan the QR code to download the "Godox Light" smartphone APP (can be used by Android and Apple system). For more smartphone APP operations, please open the "help" in APP to gain detailed guidance.



Technical Data

LED Light	SZ150R
Power Supply	AC100V-240V(50/60HZ)
Power	150W
Channel	32
Group	16(A, B, C, D, E, F, 0-9)
Color Temperature Range	2800K~ 6500K
Brightness Range	0%-100%
RGB Hue	0~360°
100% Illuminance(LUX) (darkroom, 1m distance with included reflector)	Central point
	Max. diffused light of focal length ≈19000
	Min. diffused light of focal length ≈26000
CRI (≈)	97
TLCI (≈)	96
Working Environment Temperature	-10°C~ 40°C
Special Effects Modes	37
Mode	Bicolor mode/HSI mode/situational mode
Zooming	Beam Angle 20°~ 65°
Control Method	Smartphone APP/2.4G wireless/ DMX intelligent control
Wireless Control Distance	≈50m (with optional remote control RC-R9)
Silent Mode	Yes
Display	Color Display
Dimension	336*198.6*165mm
Net Weight	2.65kg (not include reflector and protect cover)

* Product design and specifications are subject to change without notice.

Maintenance

This product, except consumables e.g. adapter and adapter cable, is supported with a one-year warranty.

Avoid sudden impacts and the product should be dedusted regularly.

Maintenance of the flash must be performed by our authorized maintenance department which can provide original accessories.

Unauthorized service will void the warranty.

If the product had failures or was wetted, do not use it until it is repaired by professionals.

Changes made to the specifications or designs may not be reflected in this manual.

Warning

Operating frequency:2412.99MHz – 2464.49MHz(2.4G only receive)/2402MHz – 2480MHz (BT)
Maximum EIRP Power: -0.83dBm

Declaration of Conformity

GODOX Photo Equipment Co.,Ltd. hereby declares that this equipment are in compliance with the essential requirements and other relevant provisions of Directive 2014/53/EU. In accordance with Article 10(2) and Article 10(10), this product is allowed to be used in all EU member states.For more information of DoC, Please click this web link:*

https://www.godox.com/DOC/Godox_SZ150R_Series_DOC.pdf

The device complies with RF specifications when the device used at 0mm from your body.

FCC Statement

This device complies with part 15 of the FCC Rules. Operation is subject to the following two conditions: (1) This device may not cause harmful interference, and (2) this device must accept any interference received, including interference that may cause undesired operation.

Any Changes or modifications not expressly approved by the party responsible for compliance could void the user's authority to operate the equipment.

Note: This equipment has been tested and found to comply with the limits for a Class B digital device, pursuant to part 15 of the FCC Rules. These limits are designed to provide reasonable protection against harmful interference in a residential installation. This equipment generates uses and can radiate radio frequency energy and, if not installed and used in accordance with the instructions, may cause harmful interference to radio communications. However, there is no guarantee that interference will not occur in a particular installation. If this equipment does cause harmful interference to radio or television reception, which can be determined by turning the equipment off and on, the user is encouraged to try to correct the interference by one or more of the following measures:

- Reorient or relocate the receiving antenna.
- Increase the separation between the equipment and receiver.
- Connect the equipment into an outlet on a circuit different from that to which the receiver is connected.
- Consult the dealer or an experienced radio/TV technician for help.