

合格证  
QC PASS

Godox

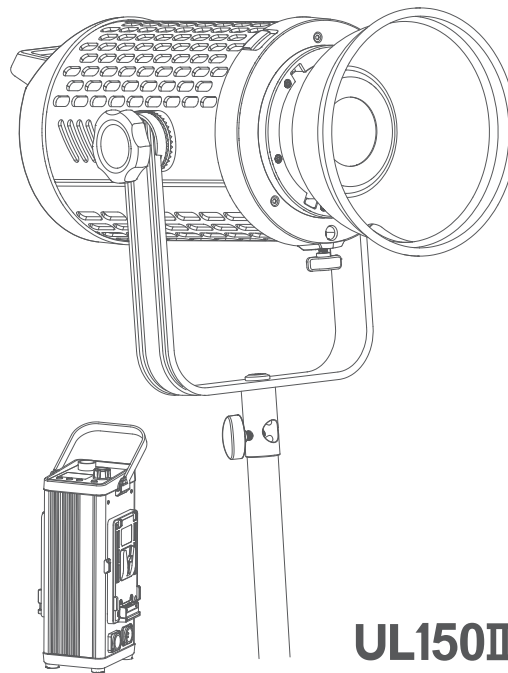

Wechat  
Official Account  
神牛微信公众号

深圳市神牛摄影器材有限公司

地址: 深圳市宝安区福海街道塘尾社区耀川工业区厂房2栋 电话: 0755-29609320(8062)

传真: 0755-25723423 邮箱: godox@godox.com

**GODOX Photo Equipment Co., Ltd.**

Add.: Building 2, Yaochuan Industrial Zone, Tangwei Community, Fuhai Street, Bao'an District, Shenzhen

518103, China Tel: +86-755-29609320(8062) Fax: +86-755-25723423 E-mail: godox@godox.com

[www.godox.com](http://www.godox.com)

Made in China | 705-U152BY-00



**UL150II Bi**

双色温静音LED摄影灯  
Bi-color Silent LED Light

说明手册  
Instruction Manual

## 重要的安全说明及注意事项

首先作为最基本原则：本产品为专业灯光布景设备，应由专业灯光师使用或在专业人士指导下使用。使用时必须始终遵循基本的安全预防措施，具体安全预防措施如下：

1. 使用前必须阅读并理解产品说明书。
2. 专业灯具，禁止儿童使用。当儿童靠近时，家长或监护人必须密切监督，以免儿童因碰撞灯具或私用灯具造成人身伤害。
3. 本灯具并非普通照明灯具，不可用于普通照明，任何有过眼部损伤或眼部敏感的人群均应避免使用本灯具。
4. 灯具点亮时，必须小心使用，禁止接触高温部件，如LED灯珠，以免造成灼伤。
5. 灯具点亮时，任何情况下均禁止直视灯珠。应该在专业灯光师指导下使用强光，任何情况下避免长时间处于强光环境，如引起眼睛不适，请及时关闭灯具，暂停使用，请及时就医。
6. 倘灯珠损坏或因热变形，应停止使用，并及时联系制造商、服务代理商或合格的维修人员更换灯珠，以免发生意外。
7. 本产品仅适用于-20°C-40°C工作环境温度及正常湿度环境下使用。
8. 请勿使用损坏的设备或设备配件，待专业维修人员检查维修，确认设备正常方可使用。
9. 在使用过程中，如果本产品由于跌落、受到挤压或遭受强烈冲击而造成外壳破裂的，请勿继续使用，以免因接触到内部电子元件而受到电击伤害。
10. 如需要延长线，请使用额定电流 $\geq$ 该设备额定电流的延长线。如延长线额定电流小于该设备，可能导致过热。
11. 部分产品电源线较长，请合理放置电源线，使其处于安全位置。避免电源线接触过热物体表面、避免放置不当导致拉扯损坏或绊倒现场人员。请使用原厂原装电源线，如使用非原厂电源线导致产品损坏，概不在本厂维修范围内。
12. 在清洁和维修之前，请务必从电源插座上拔下该设备插头。不使用时，禁止拉扯电源线以将设备插头从电源插座中拔出。正常断电，应是用手抓住该设备插头两端，将插头从电源插座中拔出。此设备需连接到接地插座中。

13. 本设备没有防水性能，请让设备保持干燥，请勿将本设备浸入水中或其他液体中。设备需安装在干燥且通风处，避免在雨天、潮湿、多尘或过热环境下使用。请勿将任何物体置于灯具上或使液体流入灯具内部，以免发生意外。
14. 请勿私自拆卸产品，如产品出现故障，须由本公司或授权的维修人员进行检查维修。
15. 存放本设备之前，请确保设备已完全冷却。存放时，将电源线从设备上拔出。设备应放置于设备便携包内或通风干燥处。
16. 请勿将设备放置在酒精、汽油等易燃易爆挥发的溶剂附近。
17. 本厂不推荐的产品附件，请勿使用，以免导致火灾、触电或人身伤害。
18. 清洁本设备时，请勿用湿布擦拭，请用干布，软布擦拭设备污垢。
19. 设备使用前，请注意将保护罩取下。
20. 本产品已通过ROHS, CE, 和FCC认证，请参考相关国家标准使用和操作。安全说明依据本厂严格测试制定，设备设计和规格如有变更，恕不另行通知。
21. 知。客户可以上神牛官网查看最新的电子版说明，了解产品最新资讯。部分产品内置锂电池。此类产品请使用专用的充电器进行充电，并且按正确的操作说明，在规定的电压、温度范围内使用。部分产品使用电池供电。此类产品请勿使用说明书中未指定的任何电池、
22. 电源或附件。请将电池和其他附件置于儿童及婴幼儿无法触及之处。如果儿童或婴幼儿吞下电池或附件，请立即就医。如果电池漏液、变色、变形、冒烟或发出异味，请立即将其取出。在取出过程中请小心，以免烫伤。如果继续使用，可能会引起火灾、触电或皮肤烫伤。请勿使用任何变形或改造过的电池。请勿拆卸或改造本产品或电池。请勿加热电池或焊接电池。请勿让电池与火或水接触。请勿让电池受到强烈的外力撞击。请勿将电池的正负端错误插入，或将新旧电池或不同类型的电池混合使用。
- 一年保修期，消耗品电池、适配器、电源线等配件不在此保修范围内。
24. 经发现，擅自检修设备，将取消一年保修期，维修需要收取相关费用。
25. 对于不规范操作引起的机器故障不在保修范围内。
- 26.

## 保存这些说明

## 前言

感谢您购买神牛产品!

静音LED摄影灯UL150II Bi无风扇,零噪音,非常适用于直播拍摄、视频录制、采访布光等多种拍摄场合。灯体与控制器分离,操作方便。光源稳定,显色性好,宽广色温,功能强大。支持蓝牙APP无线分组调光,无极调节亮度。

## 主要特点:

- 无风扇,零噪音,全功率输出稳定。
- 功率强劲,光源稳定,支持无极调节亮度(0%-100%)。
- 宽广色温,支持精准调节色温,调节范围为2800K-6500K。
- V口电池供电或AC电源供电,室内室外两用。
- 灯体与控制器分离,操控更便捷,散热性更佳。
- 支持2.4G遥控器/蓝牙APP/DMX512控制台控制。
- U型支架设计,可吊装,调节各种角度更方便。
- 拥有21种模拟场景光效,自由营造光氛围。
- 标准保荣卡口,兼容各类光效附件。

## 警告

- ⚠ 请勿让儿童接触本产品。
- ⚠ 使用前请将灯头保护罩取下。
- ⚠ 请保持干燥,请勿用湿手接触产品,亦不可将产品浸入水中或暴露于雨中。
- ⚠ 请勿私自拆卸产品,如产品出现故障须由本公司或授权的维修人员进行检查维修。
- ⚠ 本产品不能防水,在雨天及潮湿环境下请注意防水。
- ⚠ 请勿将光源对准人的眼睛,以免造成伤害。
- ⚠ 请勿放置在超过40摄氏度的高温环境中。
- ⚠ 请使用原厂原装电源线,由于使用非原厂电源线导致产品损坏,概不在原厂维修范围内。
- ⚠ 请勿在化学品、可燃性气体或其他特殊物质附近使用LED灯。
- ⚠ 本灯具光源仅可由制造商、其服务提供商或相关合格人员更换。
- ⚠ 倘灯泡损坏或热变形,应及时更换。
- ⚠ 本灯具仅供专业使用。

## 部件名称

### 灯体

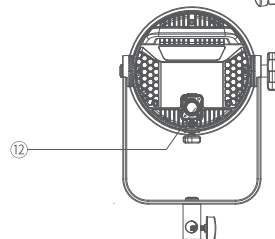
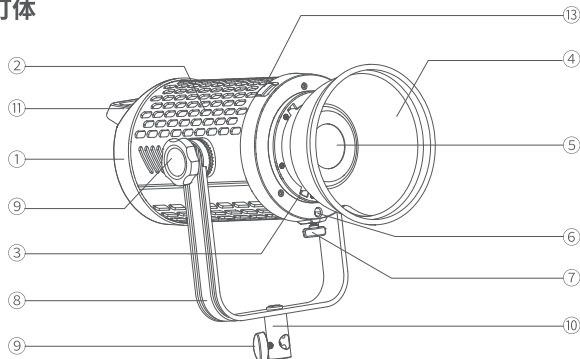

- |         |           |
|---------|-----------|
| 1.灯体    | 8.U型支架    |
| 2.散热孔   | 9.支架旋钮    |
| 3.保荣卡口  | 10.支架套筒   |
| 4.灯头保护罩 | 11.把手     |
| 5.LED灯珠 | 12.DC输入接口 |
| 6.伞孔    | 13.卡口推制   |
| 7.伞固定旋钮 |           |

### 控制器

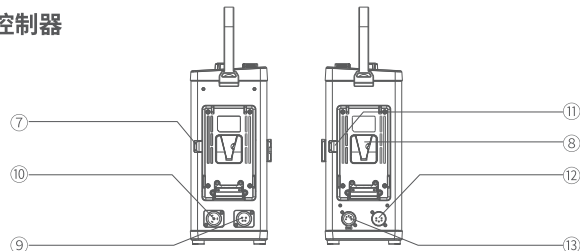

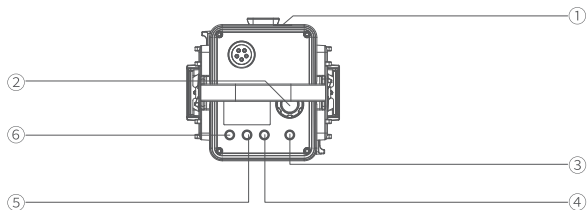

- |                 |            |                 |
|-----------------|------------|-----------------|
| 1. USB Type-A接口 | 5. 🔒 /FX按键 | 9.AC INPUT接口    |
| 2.SET调节旋钮       | 6.DMX设置键   | 10.DC 48V接口     |
| 3.开关按键          | 7.黑色拆卸电池按钮 | 11.黄色拆卸电池按钮     |
| 4.MENU菜单按键      | 8.V口电池座    | 12.DMX IN卡侬头接口  |
|                 |            | 13.DMX OUT卡侬头接口 |

## 标配物品

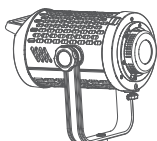

灯体x1



连接线x1



5米电源线x1



控制器固定件x1



连接线固定绳x1



灯头保护罩x1



反光罩RFT-19x1

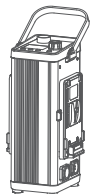

控制器x1



说明书x1

## 可选配物品

可搭配本公司摄影附件使用,以获得最佳的拍摄效果和使用体验:  
LED灯菲涅尔镜头,聚光筒,RC-A6遥控器,保险钢丝绳。

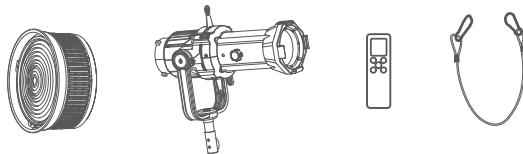

## 安装及拆卸指引

### 1. 连接控制器和灯体

按住连接线弹簧锁口按钮,将连接线一端插入灯体DC INPUT接口中。接着将另一端插入控制器DC OUTPUT接口,即可完成控制器与灯体的连接。

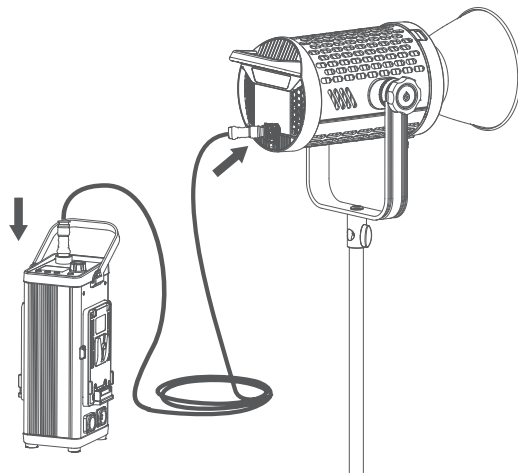

## 2. 安装到三脚架上

调整灯体到合适角度，旋转套筒旋钮安装灯体在三脚架上，最后旋转套筒旋钮固定灯体。可以通过拧松支架旋钮，调整灯体拍摄角度，调整完毕拧紧支架旋钮即可。

注：三脚架不包含在标配物品内，需另购。

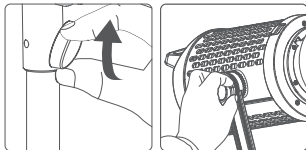

## 3. 将控制器安装到灯架上

先将控制器固定件把手拧松，然后插入灯架，旋转把手拧紧控制器固定件。最后将控制器V口对准控制器固定件卡槽，插入即可。

提示：拆卸时，只需按住卡槽推制，即可取下控制器。

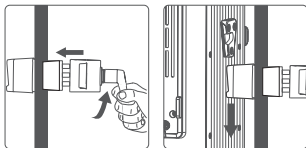

## 4. 安装及拆卸灯头保护罩

安装：推动卡口推制至末端，将灯头保护罩对准保荣卡口套上，最后顺时针旋转套紧即可。

拆卸：推动卡口推制至末端，接着逆时针旋转取出即可。

注：使用时，务必将灯头保护罩取出，否则影响灯头散热，易损坏。不使用时，套上灯头保护罩，以达到保护灯头效果。

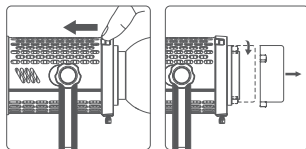

## 5. 安装及拆卸反光罩

安装：推动卡口推制至末端，将反光罩对准保荣卡口套上，最后顺时针旋转套紧即可。

拆卸：推动卡口推制至末端，接着逆时针旋转取出即可。

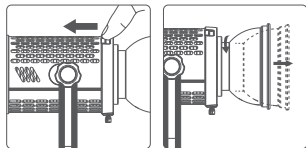

## 连接DMX控制台

控制器DMX控制台连接操作示意图如下：

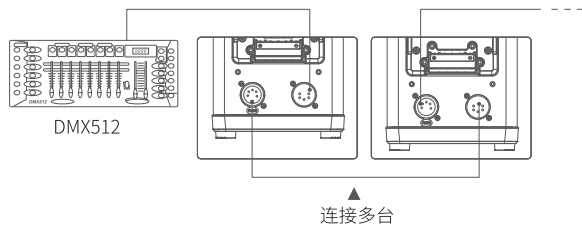

## 供电方式

### 1. AC供电

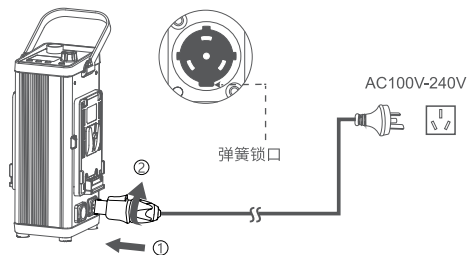

注：连接线和电源线，在安装或拆卸时，均需要按住锁扣按钮，方可安装或拆卸。

## 2. V口电池供电

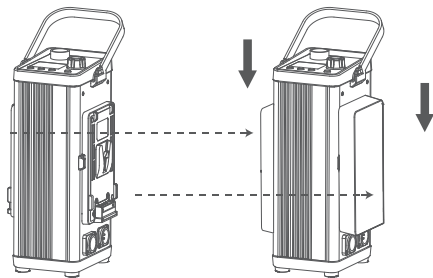

注意:支持使用14.8V或26V的V口电池。只有带黄色拆卸电池按钮一边支持单边供电。双电池供电时,其中一个电池低电量,另外一个电池即使满电,设备依然无法正常工作。电池低电量时,对应的电池图标呈现闪烁状态。建议使用双电池供电时,应先检查两个电池是否都有足够的电量。

## 显示屏

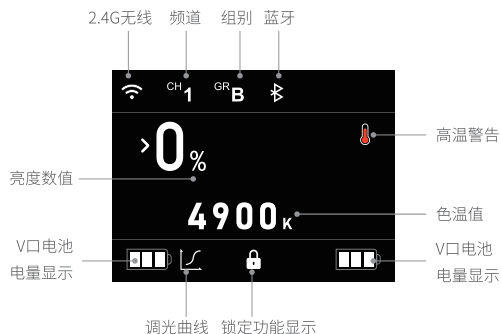

## 控制器操作说明

### 1. 开关机

接通电源,长按1秒控制器开关按键,实现开机或关机。



### 2. 亮度调节

在主界面,短按SET调节旋钮,使箭头正对着亮度值时,旋转SET调节旋钮能够调节亮度大小,调节范围为0%-100%。顺时针旋转增加亮度值,逆时针旋转减少亮度值。常规旋转,增加或减少1个单元值;快速旋转,增加或减少10个单元值。

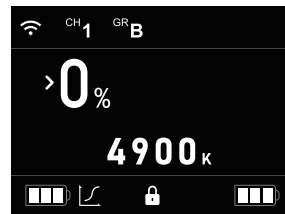

### 3. 色温调节

在主界面,短按SET调节旋钮,使箭头正对着色温值时,旋转SET调节旋钮能够调节色温大小,调节范围为2800-6500K。常规旋转,增加或减少100K单位值,快速旋转,增加或减少500个单位值。

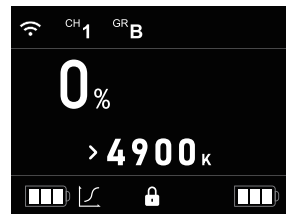

#### 4. 菜单设置

短按<MENU>菜单按键,进入菜单界面,界面依序排列着无线、蓝牙、DMX、调光曲线、屏幕亮度、语言、恢复出厂设置、版本与升级。

在菜单界面中,通过旋转SET调节旋钮进行选择,接着短按SET调节旋钮,可进入对应的设置界面。

##### 4.1 无线

在无线界面,依序排列着无线开关、频道、组别、识别号。

通过短按SET调节旋钮进行选择,选择完毕旋转SET调节旋钮进行设置,即可完成无线开关、频道、组别、识别号等一系列设置。



##### 4.2 蓝牙

在蓝牙设置界面,依序排列着蓝牙开关、重置及蓝牙MAC码。

通过短按SET调节旋钮进行选择,选择完毕旋转SET调节旋钮进行设置,即可完成蓝牙开关、蓝牙重置设置。



扫描此二维码即可下载“Godox-Light”手机APP(安卓和苹果系统都可以使用)。



**注:**首个移动设备(手机或平板电脑)可直接使用APP操控灯体。更换其他移动设备时,灯体进行蓝牙重置(Reset)后,方可正常使用APP。

#### 4.3 DMX模式

在DMX设置界面,界面上依序排列着模式与地址通道。通过短按SET调节旋钮进行选择,选择完毕后旋转SET调节旋钮进行设置,即可完成模式与地址通道设置。



#### DMX实用表

地址码	运行模式	ULTIMATE 8bit		备注
n(模式)		0-51(CCT)	52-255(FX)	
n+1		DMX*(100/255) 取整数 0-100%亮度调节	DMX*(100/255) 取整数 0-100%亮度调节	
n+2		CCT=28+DMX*(总色温数/ 255) 色温2800K-6500K	DMX*(光效总数/255)	1.例如:光效总数8, DMX=160,光效号=160*8/255=5
n+3			0-85:光效档位 I 86-171:光效档位 II 172-255:光效档位 III	

地址码	运行模式	CCT 8bit	
n		DMX*(100/255) 取整数 0-100%亮度调节	
n+1		CCT=28+DMX*(总色温数/255) 色温2800K-6500K	

地址码	运行模式	FX 8bit	
n		DMX*(100/255) 取整数 0-100%亮度调节	
n+1		DMX*(光效总数/255)	
n+2		0-85:光效档位 I ,86-171:光效档位 II ,172-255:光效档位 III	

#### 4.4 调光曲线

在调光曲线设置界面,旋转SET调节旋钮可依次选择线性/S型/指数/对数等调光曲线。



#### 4.5 屏幕亮度

在屏幕亮度设置界面，旋转SET调节旋钮可依次选择1、2、3档屏幕亮度值。



#### 4.6 语言

在语言设置界面，旋转SET调节旋钮选择English或简体中文。



#### 4.7 恢复出厂设置

在恢复出厂设置界面，旋转SET调节旋钮选择“是”或“否”，短按SET调节旋钮确认选择。选择“是”后，灯体启动重置程序，显示屏显示重置进度条。重置完毕跳回主界面。

**注：**恢复出厂设置后，亮度值为100%。



#### 4.8 版本与升级

在版本与升级界面，显示的版本号为该整体机的固件版本号。



### 5. 光效设置

短按<M/FX>按键进入FX情景光效界面。旋转SET调节旋钮依次选择闪光灯、雷闪电、坏灯泡、电视机、蜡烛、火、烟花等21种情景光效。



闪光灯光效模式



雷闪电光效模式



坏灯泡光效模式



电视机光效模式



蜡烛光效模式



火光模式





烟花光效模式

**注:**当旋转到闪光灯、雷闪电、坏灯泡、电视机等情景光效模式时,短按SET调节旋钮可进行速率(I、II、III)变换和亮度调节(0%-100%)。

**小提示:**长按3秒<锁符号/FX >按键可实现锁定/解锁功能。

## 6. 连接线没有连接好

当连接线没有连接好灯头或者控制器,显示屏出现连接线与设备分离图示,此时建议检查一下两处地方:控制器连接处是否连接和灯头连接处是否连接。

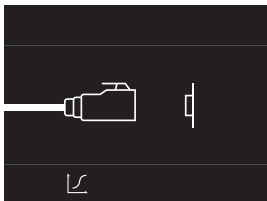

## 7.AC供电切换V口电池供电

当AC供电切换V口电池时,建议先拔掉电源线,再插入V口电池开机使用。

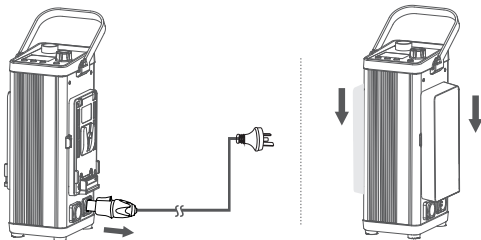

**提示:**未拔电源线插入V口电池,且灯体设置亮度值高于电池能开的最大亮度值,试图用拔掉电源线的方式切换成V口电池供电,灯体及控制器会自动关闭,重新开机后即可正常使用。

## 不同状态下UL150IIBi最大亮度值

**CCT模式:** 灯最大亮度值(%)

供电方式	线性	S型	指数	对数
14.8V(单个)	50%	50%	50%	50%
14.8V(双个)	100%	100%	100%	100%
26V(单个)	100%	100%	100%	100%
14.8V+26V	100%	100%	100%	100%
26V(双个)	100%	100%	100%	100%
AC电源/48V直流电源	100%	100%	100%	100%

**FX模式:** 灯的最大亮度值(%)

供电方式	线性
14.8V(单个)	50%
14.8V(双个)	100%
26V(单个)	100%
14.8V+26V	100%
26V(双个)	100%
AC电源/48V直流电源	100%

**注:**使用 FX 情景光效时,调光曲线不起作用,默认为线性。上述数据基于 26V 270Wh 10.5Ah 电池和 14.8V150Wh 10.2Ah 电池。

## 软件升级

- 1.在官网<http://www.godox.com.cn/Downloads.html>下载新固件到U盘上。
- 2.在关机的状态下,将已经存有新固件的U盘插入USB升级接口。
- 2.开机,摄影灯自动进入升级界面。
- 3.升级完后自动跳回主界面。

**注:** 1.必须在官网上下下载新固件,存放在U盘根目录里,而且仅有一个BIN文件。  
2.USB口仅用于升级固件功能。

## 维护保养

一年保修期,消耗品电池,适配器,电源线等配件不在此保修范围内。经发现,擅自检修此LED灯,将取消LED灯一年保修期,维修需要收取相关费用。对于不规范操作引起的机器故障不在保修范围内。

所有维修概由本厂指定的可供原配件的维修部负责。  
 如果本品出现故障或者被水淋湿,在专业人员维修后方可继续使用。  
 摄影灯在工作时,如发现异常,应立即关掉电源,查明原因。

## 规格参数

型号	UL150IIBi
功率	最大155W
AC供电输入	100-240V ~50/60Hz
DC供电输入	DC 48V
灯头输入	39V = 3.9A
V口电池(另购)规格参数	14.8V, 150Wh/26V, 270Wh
频道	32个(1~32)
组别	16组(0~9、A~F)
识别号(ID号)	1~99、OFF
色温数值	2800K-6500K
CRI	≥96
TLCI	≥97
工作环境温度	-20~40°C
FX情景光效	7类21种
控制方式	支持DMX512控制、2.4G无线遥控、蓝牙控制、控制盒控制
调光模式	4种:线性/S型/指数/对数
静音模式	具备
蓝牙传输距离	≈30m
2.4G无线控制距离	≈60m
灯体尺寸	316.9*217.8*170mm
控制器尺寸	270.4*123.6*132mm
灯体重量	≈3.13kg
控制器重量	≈2.79kg

设计和规格如有变更,恕不另行通知。

## 照度数据

色温	测试条件	照度单位	1m	2m	3m
2800K	裸灯	lux	3480	920	470
		fc	324	85.7	43.5
	带标罩	lux	40900	8350	3750
		fc	3800	776	348
3200K	裸灯	lux	3870	1040	530
		fc	359	968	49.3
	带标罩	lux	46100	9490	4260
		fc	4290	882	396
4300K	裸灯	lux	4360	1200	608
		fc	405	111	56.5
	带标罩	lux	53000	10900	4190
		fc	4920	1010	457
5600K	裸灯	lux	4500	1230	623
		fc	418	114	57.9
	带标罩	lux	54700	11200	5040
		fc	5080	1040	468
6500K	裸灯	lux	4380	1210	613
		fc	407	112	56.9
	带标罩	lux	53900	11000	5000
		fc	5000	1030	464

注:上述测试皆在灯体100%亮度下进行。

本设备包含型号核准代码为:CMITID: 2020DP13510,为该产品的无线电发射模块。

## Safety Instructions and Attention

First of all, as the most basic principle: This product is a professional lighting set equipment and should be used by professional lighting engineers or under the guidance of professionals. Basic safety attentions must always be followed during use, as follows:

1. Before use, please read and understand these instructions and attentions.
2. Professional lighting is prohibited for children. When children are near, parents or accompanying persons must supervise closely to prevent children from personal injury due to collision with lamps or private use of lamps.
3. This lighting product is not ordinary lighting product and cannot be used for general lighting. Anyone who has suffered eye damage or has sensitive eyes should avoid using this product.
4. When the lamp is on, it must be used with care. Do not touch high-temperature parts, such as LED lamp beads, to avoid burns.
5. When the lamp is on, it is forbidden to look directly at the lamp beads under any circumstances. Strong light should be used under the guidance of professional lighting engineers. Avoid prolonged exposure to strong light under any circumstances. If eye discomfort, please turn off the lamp in time, suspend use, and see a doctor immediately.
6. If the lamp bead is damaged or deformed by heat, stop using this equipment, and contact the manufacturer, service agent or qualified maintenance personnel to replace the lamp bead in time to avoid accidents.
7. This product is only suitable for use in -20°C to 40°C operating environment and normal humidity environment.
8. Do not use damaged equipment or accessories, and wait for professional maintenance personnel to check and repair to confirm being normal before use.
9. During using, if the casing of this product is broken due to being dropped, squeezed or subjected to strong impact, please do not use it, so as to avoid electric shock injury due to contact with internal electronic components.
10. If an extension cord is required, please use an extension cord with a current rating greater than or equal to that of the equipment. If an extension cord is rated less than the equipment, overheating may result.
11. Some products have long power cords, please place the power cords properly and keep them in a safe place. Avoid contacting the power cord with overheating surfaces, avoid improper placement that could cause pulling damage, or trip on-site personnel. Please use the certified power cord from the original manufacturer. If the product is damaged by using a non-certified power cord, it will not be repaired by our factory.
12. Be sure to unplug equipment from the power outlet before cleaning and repairing. When not in use, do not pull the power cord to unplug the equipment. For normal power-off, please hold both ends of the plug of the equipment with your hands and pull the plug out of power outlet. This equipment needs to be connected to a grounded outlet.

13. This equipment is not waterproof, please keep it dry and do not immerse it in water or other liquids. The equipment should be installed in a dry and ventilated place, and avoid using it in rainy, humid, dusty or overheated environments. Do not place any objects on the lamp or let liquid flow into the lamp to avoid accidents.
14. Do not disassemble the product without permission. If the product fails, it must be checked and repaired by authorized maintenance personnel.
15. Before storing, make sure that the equipment has cooled down completely. For storage, unplug the power cord from the equipment. The equipment should be placed in the carrying case or in a ventilated dry place.
16. Do not place equipment near flammable and volatile solvents such as alcohol and gasoline.
17. Do not use accessories that are not recommended by our factory to avoid fire, electric shock or personal injury.
18. When cleaning, do not wipe it with a damp cloth, please use a dry cloth or a soft cloth to wipe the dirt of the equipment.
19. Please take off the protective cover before using.
20. This product complies with ROHS, CE, and FCC certification, please refer to the relevant national standards for use and operation.
21. The safety instructions are formulated according to the strict testing of the factory, and the design and specifications of the equipment are subject to change without prior notice. For latest product information, please check the GODOX website and view latest electronic instruction.
22. Some products have built-in lithium batteries. Please use specified chargers, and use them within a proper range of the specified voltage and temperature according to the correct operating instructions.
23. Some products are battery powered. Do not use any batteries, power sources or accessories not specified in the instructions for such products. Keep batteries and other accessories out of the reach of children and infants. In the instance that a child or infant swallows a battery or accessory, immediate emergency medical attention is required. If the battery leaks, becomes discolored, deformed, emits smoke, or emits an abnormal odor, remove it immediately. Be careful during removal to avoid burns. Continued use could result in fire, electric shock, or burns. Do not use any deformed or modified batteries. Do not disassemble or modify this product or battery. Do not heat or solder the battery. Keep the battery away from fire or water. Do not incorrectly insert the positive and negative ends of batteries, or mix old and new batteries or batteries of different types together.
24. One-year warranty period, accessories such as consumable batteries, adapters, power cords, etc. are not covered by this warranty.
25. If it is found that the equipment is repaired without authorization, the one-year warranty period will be cancelled and relevant fees will be charged for maintenance.
26. Machine failures caused by non-standard operation are not covered by the warranty.

**keep these instructions!**

## Foreword

Thank you for purchasing!

Silent LED Video Light UL150IIBi is fanless design and noise-free. The separate light body and controller are conveniently operational. Stable light source creates high CRI and wide CCT range brings great performance. It supports Bluetooth APP wireless group control and stepless brightness adjustment. This product is suitable for various shooting scenes such as live streaming, video recording, interview and etc.

## Main Features

Fanless and noise-free, stable full power output.

Strong power and stable light source, support stepless brightness adjustment.

Wide CCT range can be precisely adjusted from 2800K to 6500K.

V-mount battery supply or AC power supply, available both indoors and outdoors.

Separated design of light body and controller achieves convenient operation and better cooling effect.

Support 2.4G remote control/Bluetooth APP control/DMX512 control.

U-bracket to support various angle usage.

21 simulated light effects bring rich lighting creations.

Standard Bowens mount is compatible with most optical accessories.

## ⚠ Warning

- △ Keep out of reach of children.
- △ Please take off the lamp cover before using.
- △ Always keep this product dry. Do not use in rain or in damp conditions.
- △ Do not disassemble. Should repairs become necessary, this product must be sent to an authorized maintenance center.
- △ As this product do not have waterproof function, please take measures of waterproof in rainy or damp environment.
- △ Do not fire directly against human eyes as it may cause visual impairment.
- △ Do not leave or store the product if the ambient temperature reads over 40°C.
- △ Please use the original power cable, damages caused by using other cables will invalid the warranty.
- △ Do not use the product in the presence of flammable gases, chemicals and other similar materials.
- △ The light source contained in this luminaire shall only be replaced by the manufacturer or his service agent or a similar qualified person.
- △ The lamp shall be changed if it has become damaged or thermally deformed
- △ The luminaire is intended for professional use only.

## Name of Parts Light Body

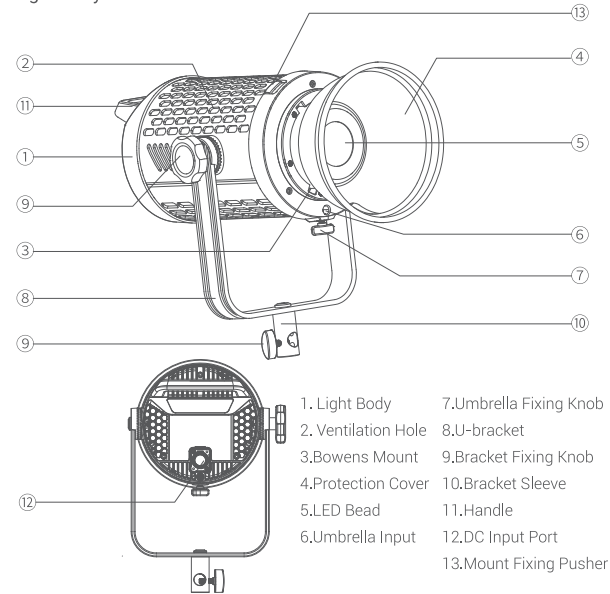

## Controller

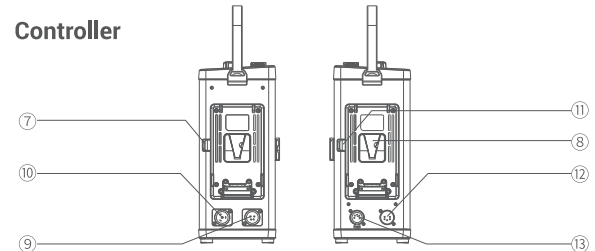

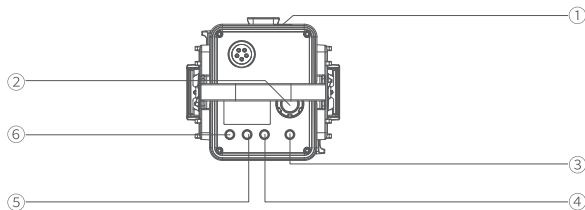

- |                       |                                |                                  |
|-----------------------|--------------------------------|----------------------------------|
| 1.USB Type-A Port     | 5. Lock /FX Button             | 9.AC INPUT Port                  |
| 2.SET Adjustment Dial | 6.DMX Setting Button           | 10.DC 48V Port                   |
| 3.Power Switch Button | 7.Black Battery Removal Button | 11.Yellow Battery Removal Button |
| 4.MENU Button         | 8.V-mount Battery Box          | 12.DMX IN XLR Port               |
|                       |                                | 13.DMX OUT XLR Port              |

## What's in the Box

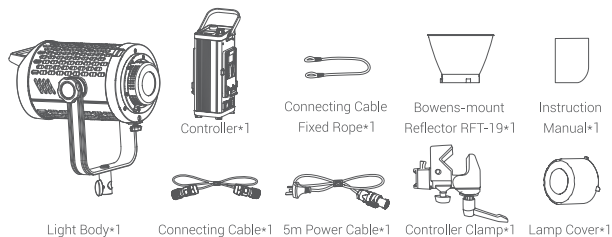

## Separately Sold Accessories

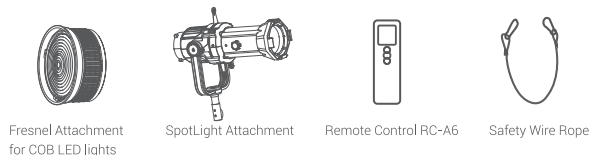

## Installation and Disassembly Guide

### 1. Connect the controller and the light body

Press and hold the spring latch button of the connecting cable, insert the connecting cable into the DC INPUT Port of the light body, then insert the other end of the connecting cable into the DC OUTPUT Port of the controller to complete the connection.

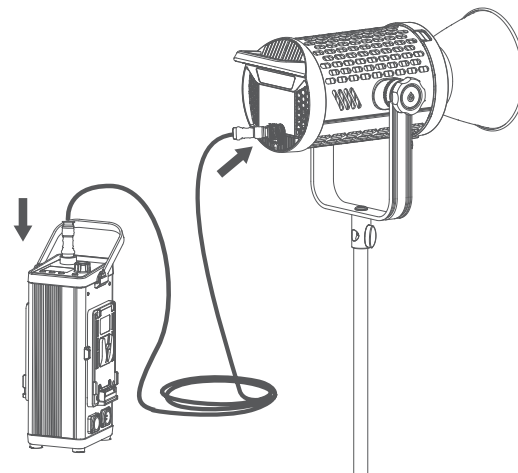

### 2. Mount on the tripod

Adjust the light body to a proper angle, rotate the screw of sleeve knob to install the light body on the tripod, then rotate the screw of sleeve knob to fix the light body on the tripod. The inclination angle of the light body could be adjusted by loosening the bracket angle adjustment handle and then screwing down the handle afterwards.

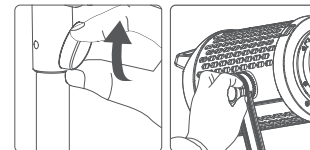

**Note:** The tripod belongs to separately sold accessories.

### 3. Mount on the light stand

Loosen the handle of the controller clamp, then insert the light stand and rotate the handle to tighten. Finally, insert the V port of the controller into the clamp slot.

**Tip:** Press and hold the mount fixing pusher can easily remove the controller.

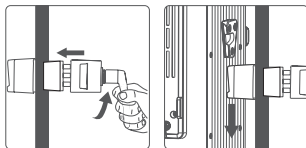

### 4. Installation and disassembly the protection cover

**Installation:** Press the Mount Fixing pusher top-down, put the protection cover on Bowers Mount, and rotate clockwise to tighten it.

**Disassembly:** Press the Mount Fixing pusher top-down, then rotate counter-clockwise to remove it.

**Note:** Make sure to remove the protection cover before use to avoid overheating damage. Put on the protection cover to protect the lamp when not in use.

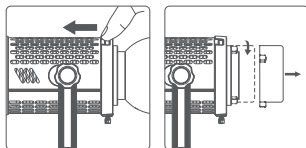

### 5. Installation and disassembly the standard reflector

**Installation:** Press the Mount Fixing pusher top-down, put the reflector on Bowers Mount, and rotate clockwise to tighten it.

**Disassembly:** Press the Mount Fixing pusher top-down, then rotate counter-clockwise to remove it.

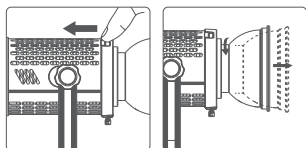

## Connect to DMX Controller

The connecting operation diagram of Controller and DMX Controller is as follows:

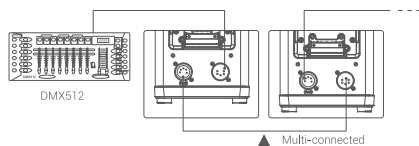

25

## Power Supply

### 1. AC Power Supply

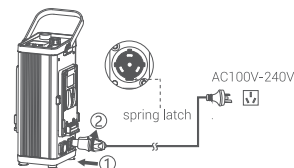

**Note:** Please press the latch button when installing or disassembling the power cable and connecting cable.

### 2. V-mount battery power supply

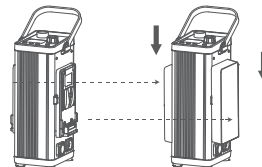

**Note:** The light can be supplied by 14.8V or 26V V-mount battery. Only the side with yellow battery removal button supports unilateral power supply. When it is powered by two batteries and one of which is low, the device still can't work normally even if the other one is full. The corresponding battery icon will blink in low battery mode. It is recommended to check whether both batteries have sufficient power when using two batteries.

## Display Screen

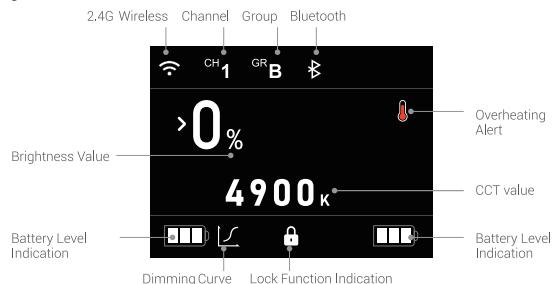

26

## Controller Operation Instruction

### 1. Turn On/Off

Press the controller Power Switch Button for 1 second after connecting to the power supply to turn on or off.



### 2. Brightness Adjustment

Short press the SET adjustment dial on the main interface to make the arrow aimed at the brightness value, then turn it to adjust brightness from 0% to 100%. Rotate clockwise to increase brightness, and counterclockwise to decrease brightness. The brightness will increase or decrease by 1 unit in normal rotation speed; and increase or decrease by 10 unit in rapid rotation speed.



### 3. CCT Adjustment

Short press the SET adjustment dial on the main interface to make the arrow aimed at the CCT value, then turn it to adjust the CCT from 2800K to 6500K. The CCT value will increase or decrease 100K in normal speed and 500K in fast speed.

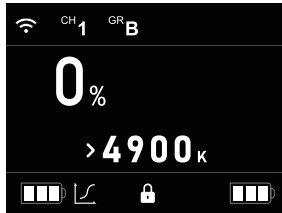

### 4. Menu Setting

Short press < MENU > Button to enter the menu interface, displayed in order with Wireless, Bluetooth, DMX, Dimmer, Screen Bright, Language, Reset, Version & Upgrade. Turn and short press the SET adjustment dial on the menu interface to select and enter the corresponding setting options interface.

#### 4.1 Wireless

The Wireless interface is displayed in order with Wireless Switch, Channel, Group and ID. Short press & turn the SET adjustment dial to complete the settings of Wireless Switch, Channel, Group and ID.



#### 4.2 Bluetooth

The Bluetooth interface is displayed in order with Bluetooth Switch, Reset and MAC Code.

Short press & turn the SET adjustment dial to complete the settings of Bluetooth Switch and Bluetooth Reset.

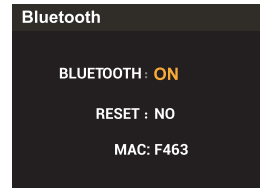

For more smartphone APP operations, please open the "help" in "GodoxLight" APP to gain detailed guidance (both Android and IOS systems are available).

**Note:** the APP can be used directly on the firstly installed device (smartphone or tablet). When changing to other mobile device, the light shall be reset before the normal usage of APP.



### 4.3 DMX

The DMX Setting interface is displayed with Mode and Address. Short press the SET adjustment knob to choose between mode and address, then turn it to set mode and address.



### DMX Practical Form

Address Code	Operating Mode		Note
	ULTIMATE 8bit		
n (Mode)	0-51 (CCT)	52-255 (FX)	
n+1	DMX*(100/255) Integer 0-100% Brightness Adjustment	DMX*(100/255) Integer 0-100% Brightness Adjustment	
n+2	CCT=28+DMX*(Total CCT/255) CCT 2800K-6500K	DMX*(Total FX/255)	1. For example: Total FX 8, DMX=160 FX No.=160*8/255=5
n+3		0-85: FX Level I 86-171: FX Level II 172-255: FX Level III	

Address Code	Operating Mode	
	CCT 8bit	
n	DMX*(100/255) Integer 0-100% Brightness Adjustment	
n+1	CCT=28+DMX*(Total CCT/255) CCT 2800K-6500K	

Address Code	Operating Mode	
	FX 8bit	
n	DMX*(100/255) Integer 0-100% Brightness Adjustment	
n+1	DMX*(Total FX/255)	
n+2	0-85: FX Level I, 86-171: FX Level II, 172-255: FX Level III	

### 4.4 Dimmer

Turn the SET adjustment dial on the Dimmer interface to choose linear/S-curve/exponential/logarithmic dimming curve.

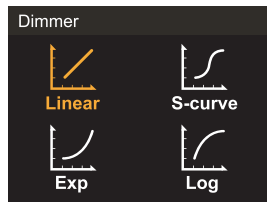

### 4.5 Screen Bright

Turn the SET adjustment dial on the screen bright setting interface to choose 1, 2, 3 levels of screen brightness.

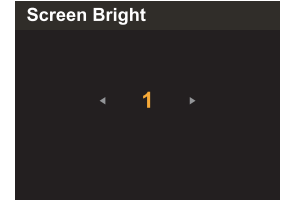

### 4.6 Language

Turn the SET adjustment dial on the Language interface to choose English or Simplified Chinese.

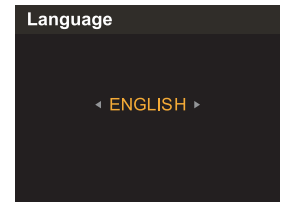

### 4.7 Reset

Turn the SET adjustment dial on the Reset interface to choose "Yes" or "No" and short press to confirm. If you choose "Yes", the system will initiate resetting program and resetting progress bar is displayed on the screen, after which it will return to the main interface.

Note: The brightness will change to 100% after resetting.



### 4.8 Version & Upgrade

The Version Code displayed on the Version & Upgrade interface is the firmware version of the product.





## 5. Light Effect Setting

Short press <lock/FX> button to enter FX light effect interface, turn the SET adjustment dial to choose flash, lightning, broken bulb, TV, candle, fire or firework scenes.



Flash Mode



Lightning Mode

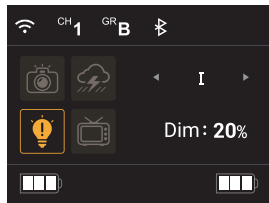

Broken Bulb Mode

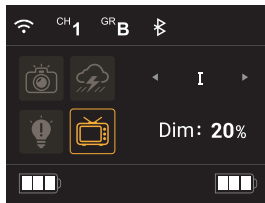

TV Mode

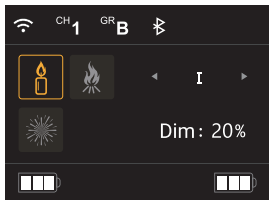

Candle Mode



Fire Mode



Firework Mode

**Note:** Short press the SET adjustment dial to change the rate (I, II, III) and adjust brightness (0%-100%) after choosing one of the above Light Effects.

**Tips:** Long press the <lock/FX> button to lock/unlock the screen.

## 6. Connecting Cable Issue

When the connecting cable is not correctly connected to the light or controller, a separated icon of connecting cable and device is displayed on the panel. Please check the connecting ports of the controller and light.

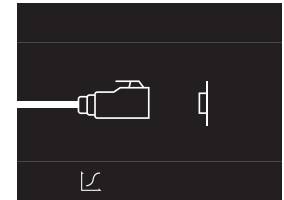

## 7. Switch from AC Power Supply to V-mount Battery Power Supply

Unplug the power cable and install V-mount battery then turn on the product.

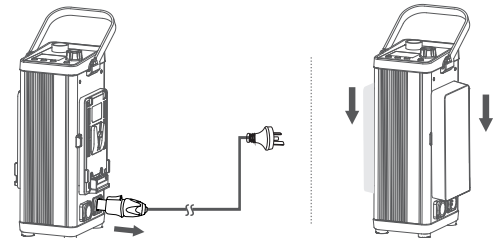

**Note:** If you install the V-mount battery before unplugging the power cable, and the brightness value is set higher than the maximum brightness that the battery can be turned on, then you switch to V-mount battery power supply by unplugging the power cable, the light and the controller will automatically power off. The machine can only resume normal operation after reboot.

## Maximum Brightness in Different States

**CT mode:** Maximum Brightness (%)

Power Supply	linear	S-curve	exponential	logarithmic
14.8V(single)	50%	50%	50%	50%
14.8V(double)	100%	100%	100%	100%
26V(single)	100%	100%	100%	100%
14.8V+26V	100%	100%	100%	100%
26V(double)	100%	100%	100%	100%
AC Power Supply/48V DC Power Supply	100%	100%	100%	100%

**FX mode:** Maximum Brightness (%)

Power Supply	linear
14.8V(single)	50%
14.8V(double)	100%
26V(single)	100%
14.8V+26V	100%
26V(double)	100%
AC Power Supply/48V DC Power Supply	100%

**Note:** The dimming curve is not adjustable in FX mode, it is linear in default. The above data is based on 26V 270Wh 10.5Ah battery and 14.8V 150Wh 10.2 Ah battery.

## Software Upgrade

- 1.Download the new firmware to the U disk from the official website (<http://www.godox.com.cn/Downloads.html>).
2. Turn off the device. Insert the U disk with new firmware into the USB upgrade port.
3. Turn on the device, and it will automatically enter the upgrading interface.
- 4.It will return to main interface after completion.

## Notes:

1. New firmware must be downloaded from the official website, and keep only one BIN file in the root directory of the USB disk.
2. The USB port can only support firmware upgrade function.

## Maintenance

This product, except consumables e.g. adapter and power cable, is supported with a one-year warranty.

Maintenance of the light must be performed by our authorized maintenance department which can provide original accessories.

Unauthorized service will void the warranty.

If the product breaks down or gets wet, please do not use it until repaired by professionals.

If there is anything abnormal during LED light' s working, please turn it off immediately and identify the reasons.

## Warning

Operating frequency:2412,99MHz – 2464.49MHz(2.4G only receive)/2402MHz – 2480MHz (BT)  
Maximum EIRP Power: 5.63dBm

## Declaration of Conformity

GODOX Photo Equipment Co.,Ltd. hereby declares that this equipment are in compliance with the essential requirements and other relevant provisions of Directive 2014/53/EU. In accordance with Article 10(2) and Article 10(10), this product is allowed to be used in all EU member states.For more information of DoC, Please click this web link:

<https://www.godox.com/eu-declaration-of-conformity/>

The device complies with RF specifications when the device used at 0mm from your body.

## Technical Data

Mode	UL150IIBi
Power	Max.155W
AC Power Input	AC100~240V ~50/60Hz
DC Power Input	DC 48V
Light Head Input	39V=3.9A
V-mount Battery (optional)	14.8V, 150Wh/26V, 270Wh
Specifications	
Channel	1~32
Group	16 groups (0~9、A~F)
ID	1~99、OFF
Color Temperature	2800K-6500K
CRI	≥96

TLCI	≥97
Working Environment Temperature	-20~40 C
FX Light Effect	21 kinds within 7 types
Controlling Method	Support DMX512, 2.4G Wireless Control, Bluetooth Control, Controller
Dimming Curve	4 types: linear/S-curve/exponential/logarithmic
Mute Mode	YES
Bluetooth Transmission Distance	≈30m
2.4G Wireless Control Distance	≈60m
Light Body Dimension	316.9*217.8*170mm
Controller Dimension	270.4*123.6*132mm
Light Body Weight	≈3.13kg
Controller Weight	≈2.79kg
Bluetooth Transmission Frequency	2402MHz-2480.0MHz
Maximum Transmit Power	5dbm
2.4G Frequency Range	2412MHz-2464.5MHz

### Illuminance Testing Data

CCT	Testing Conditions	Illuminance Unit	1m	2m	3m
2800K	bare lamp	lux	3480	920	470
		fc	324	85.7	43.5
	with reflector	lux	40900	8350	3750
		fc	3800	776	348
3200K	bare lamp	lux	3870	1040	530
		fc	359	968	49.3
	with reflector	lux	46100	9490	4260
		fc	4290	882	396
4300K	bare lamp	lux	4360	1200	608
		fc	405	111	56.5
	with reflector	lux	53000	10900	4190
		fc	4920	1010	457

5600K	bare lamp	lux	4500	1230	623
		fc	418	114	57.9
	with reflector	lux	54700	11200	5040
		fc	5080	1040	468
6500K	bare lamp	lux	4380	1210	613
		fc	407	112	56.9
	with reflector	lux	53900	11000	5000
		fc	5000	1030	464

Note: The above tests are all based on the condition of 100% brightness.

### FCC Statement

This device complies with part 15 of the FCC Rules. Operation is subject to the following two conditions: (1) This device may not cause harmful interference, and (2) this device must accept any interference received, including interference that may cause undesired operation.

Any Changes or modifications not expressly approved by the party responsible for compliance could void the user's authority to operate the equipment.

Note: This equipment has been tested and found to comply with the limits for a Class B digital device, pursuant to part 15 of the FCC Rules. These limits are designed to provide reasonable protection against harmful interference in a residential installation. This equipment generates uses and can radiate radio frequency energy and, if not installed and used in accordance with the instructions, may cause harmful interference to radio communications. However, there is no guarantee that interference will not occur in a particular installation. If this equipment does cause harmful interference to radio or television reception, which can be determined by turning the equipment off and on, the user is encouraged to try to correct the interference by one or more of the following measures:

- Reorient or relocate the receiving antenna.
- Increase the separation between the equipment and receiver.
- Connect the equipment into an outlet on a circuit different from that to which the receiver is connected.
- Consult the dealer or an experienced radio/TV technician for help.

The device has been evaluated to meet general RF exposure requirement.

The device can be used in portable exposure condition without restriction.

## 产品保修

尊敬的用户, 本保修卡是申请保修服务的重要凭证, 请您配合销售商填写并妥善保管, 谢谢!

产品信息	型号	产品条码
用户信息	姓名	联系电话
	通信地址	
销售商信息	名称	
	联系电话	
	通信地址	
	销售日期	
备注		

注: 此表应由销售商盖章确认。

### 适用产品

本文件适用于相关《产品保修信息》(见后面说明)所列产品, 其他非属此范围的产品或部件(如促销品、赠品及其他出厂后附加的部件等)不在此保修承诺内。

### 保修期

产品及部件的相应保修期按相关的《产品保修信息》执行。保修期自产品首次购买日起算, 购买日以购买产品时保修卡登记日期为准。

### 如何获得保修服务

您可直接与产品销售商或授权服务机构联系, 也可拨打神牛产品售后服务电话, 与我们联系, 由我们的服务人员为您安排服务。申请保修时, 您应提供有效的保修卡作为保修凭证, 方可获得保修。如您不能提供有效的保修卡, 则在我们确认产品或部件属于保修范围的情况下, 也可以为您提供保修, 但这不作为我们的义务。

### 不适用保修的情况

如产品存在下列情况, 本文件项下的保证和服务将不适用 ①产品或部件超过相应保修期; ②错误或不当使用、维护或保管导致的故障或损坏, 如: 不当搬运; 非按产品合理预期用途使用; 不当插拔外接设备; 跌落或外力挤压; 接触或暴露于不当温度、溶剂、酸碱、水浸或潮湿环境; ③由非神牛授权机构或人员安装、修理、更改、添加或拆卸造成的故障或损坏; ④产品或部件原有识别信息被修改变更或除去; ⑤无有效保修卡; ⑥使用非合法授权、非标准或非公开发行的软件造成的故障或损坏; ⑦因不可抗力或意外事件造成的故障或损坏; ⑧其他非因产品本身质量问题导致的故障或损坏。遇上述情况, 您应向相关责任方寻求解决, 神牛对此不承担任何责任。因非在保修期或保修范围内的部件、附件或软件导致产品不能正常使用的, 不是保修范围内的故障。产品使用过程中正常的脱色、磨损和消耗, 不是保修范围内的故障。

## 产品保修和服务支持信息

产品的保修期和服务类型按以下《产品保修信息》执行:

产品类别	选件名称	保修期 (月)	保修服务类型
部件	电路板	12	客户送修
	电池	3	客户送修
	充电器、电源线, 同步线等带电性能的部件。	12	客户送修
其他	如闪光灯管、造型灯泡、外壳、保护罩、锁紧装置、包装等。	无	无保修

神牛产品售后服务电话: 0755-29609320-8062

## Warranty

Dear customers, as this warranty card is an important certificate to apply for our maintenance service, please fill in the following form in coordination with the seller and safe-keep it. Thank you!

Product Information	Model	Product Code Number
Customer Information	Name	Contact Number
	Address	
Seller Information	Name	
	Contact Number	
	Address	
	Date of Sale	
Note:		

Note: This form shall be sealed by the seller.

### Applicable Products

The document applies to the products listed on the Product Maintenance Information (see below for further information). Other products or accessories (e.g. promotional items, giveaways and additional accessories attached, etc.) are not included in this warranty scope.

### Warranty Period

The warranty period of products and accessories is implemented according to the relevant Product Maintenance Information. The warranty period is calculated from the day(purchase date) when the product is bought for the first time, And the purchase date is considered as the date registered on the warranty card when buying the product.

### How to Get the Maintenance Service

If maintenance service is needed, you can directly contact the product distributor or authorized service institutions. You can also contact the Godox after-sale service call and we will offer you service. When applying for maintenance service, you should provide valid warranty card. If you cannot provide valid warranty card, we may offer you maintenance service once confirmed that the product or accessory is involved in the maintenance scope, but that shall not be considered as our obligation.

### Inapplicable Cases

The guarantee and service offered by this document are not applicable in the following cases: ①. The product or accessory has expired its warranty period; ②. Breakage or damage caused by inappropriate usage, maintenance or preservation, such as improper packing, improper usage, improper plugging in/out external equipment, falling off or squeezing by external force, contacting or exposing to the improper temperature, solvent, acid, base, flooding and damp environments, etc; ③. Breakage or damage caused by non-authorized institution or staff in the process of installation, maintenance, alternation, addition and detachment; ④. The original identifying information of product or accessory is modified, alternated, or removed; ⑤. No valid warranty card; ⑥. Breakage or damage caused by using illegally authorized, nonstandard or non-public released software; ⑦. Breakage or damage caused by force majeure or accident; ⑧. Breakage or damage that could not be attributed to the product itself. Once met these situations above, you should seek solutions from the related responsible parties and Godox assumes no responsibility. The damage caused by parts, accessories and software that beyond the warranty period or scope is not included in our maintenance scope. The normal discoloration, abrasion and consumption are not the breakage within the maintenance scope.

## Maintenance and Service Support Information

The warranty period and service types of products are implemented according to the following Product Maintenance Information:

Product Type	Name	Maintenance Period(month)	Warranty Service Type
Parts	Circuit Board	12	Customer sends the product to designated site
	Battery	3	Customer sends the product to designated site
	Electrical parts e.g.battery charger, power cord, sync cable, etc.	12	Customer sends the product to designated site
Other Items	Flash tube, modeling lamp, lamp body, lamp cover, locking device, package, etc.	NO	Without warranty

Godox After-sale Service Call 0755-29609320-8062