

VL150 II VL200 II VL300 II

LED 摄影灯
LED Video Light

使用手册
Instruction Manual

重要的安全说明及注意事项

首先作为最基本原则：本产品为专业灯光布景设备，应由专业灯光师使用或在专业人士指导下使用。使用时必须始终遵循基本的安全预防措施，具体安全预防措施如下：

1. 使用前必须阅读并理解产品说明书。
2. 专业灯具，禁止儿童使用。当儿童靠近时，家长或监护人必须密切监督，以免儿童因碰撞灯具或私用灯具造成人身伤害。
3. 本灯具并非普通照明灯具，不可用于普通照明，任何有过眼部损伤或眼部敏感的人群均应避免使用本灯具。
4. 灯具点亮时，必须小心使用，禁止接触高温部件，如 LED 灯珠，以免造成灼伤。
5. 灯具点亮时，任何情况下均禁止直视灯珠。应该在专业灯光师指导下使用强光，任何情况下避免长时间处于强光环境，如引起眼睛不适，请及时关闭灯具，暂停使用，请及时就医。
6. 倘灯珠损坏或因热变形，应停止使用，并及时联系制造商、服务代理商或合格的维修人员更换灯珠，以免发生意外。
7. 本产品仅适用于 -10°C -40°C 工作环境温度及正常湿度环境下使用。
8. 请勿使用损坏的设备或设备配件，待专业维修人员检查维修，确认设备正常方可使用。
9. 在使用过程中，如果本产品由于跌落、受到挤压或遭受强烈冲击而造成外壳破裂的，请勿继续使用，以免因接触到内部电子元件而受到电击伤害。
10. 如需要延长线，请使用额定电流 \geq 该设备额定电流的延长线。如延长线额定电流小于该设备，可能导致过热。
11. 部分产品电源线较长，请合理放置电源线，使其处于安全位置。避免电源线接触过热物体表面、避免放置不当导致拉扯损坏或绊倒现场人员。请使用本厂原装电源线，如使用非本厂电源线导致产品损坏，概不在本厂维修范围内。
12. 在清洁和维修之前，请务必从电源插座上拔下该设备插头。不使用时，禁止拉扯电源线以将设备插头从电源插座中拔出。正常断电，应用手抓住该设备插头两端，将插头从电源插座中拔出。此设备需连接到接地插座中。
13. 本设备没有防水性能，请让设备保持干燥，请勿将本设备浸入水中或其他液体中。设备需安装在干燥且通风处，避免在雨天、潮湿、多尘或过热环境下使用。请勿将任何物体置于灯具上或使液体流入灯具内部，以免发生意外。
14. 请勿私自拆卸产品，如产品出现故障，须由本公司或授权的维修人员进行检查维修。
15. 存放本设备之前，请确保设备已完全冷却。存放时，将电源线从设备上拔出。设备应放置于设备便携包内或通风干燥处。
16. 请勿将设备放置在酒精、汽油等易燃易爆挥发的溶剂附近。
17. 本厂不推荐的产品附件，请勿使用，以免导致火灾、触电或人身伤害。
18. 清洁本设备时，请勿用湿布擦拭，请用干布，软布擦拭设备污垢。
19. 设备使用前，请注意将保护罩取下。
20. 本产品已通过 ROHS, CE 和 FCC 认证，请参考相关国家标准使用和操作。

21. 安全说明依据本厂严格测试制定，设备设计和规格如有变更，恕不另行通知。客户可以上神牛官网查看最新的电子版说明，了解产品最新资讯。
22. 部分产品内置锂电池。此类产品请使用专用的充电器进行充电，并且按正确的操作说明，在规定的电压、温度范围内使用。
23. 部分产品使用电池供电。此类产品请勿使用说明书中未指定的任何电池、电源或附件。请将电池和其他附件置于儿童及婴幼儿无法触及之处。如果儿童或婴幼儿吞下电池或附件，请立即就医。如果电池漏液、变色、变形、冒烟或发出异味，请立即将其取出。在取出过程中请小心，以免烫伤。如果继续使用，可能会引起火灾、触电或皮肤烫伤。请勿使用任何变形或改造过的电池。请勿拆卸或改造本产品或电池。请勿加热电池或焊接电池。请勿让电池与火或水接触。请勿让电池受到强烈的外力撞击。请勿将电池的正负端错误插入，或将新旧电池或不同类型的电池混合使用。
24. 一年保修期，消耗品电池、适配器、电源线等配件不在此保修范围内。
25. 经发现，擅自检修设备，将取消一年保修期，维修需要收取相关费用。
26. 对于不规范操作引起的机器故障不在保修范围内。

保存这些说明

前言

感谢您购买神牛产品！

LED 摄影灯 VLII 系列，科学散热设计，适配器、控制盒、灯体一一分离，安全系数高。此外 VLII 系列拥有功率强劲，光源稳定，超高显色，强悍性能等诸多特性，常适用于儿童摄影、影棚拍摄、采访布光、静物拍摄以及视频拍摄等拍摄场景；支持蓝牙控制，下载“Godox Light”APP，即可远程控制。抑或另购神牛 RC-A6 遥控器，实现无线调光。VLII 系列共有三款产品，分别为 VL150II、VL200II、VL300II。

主要特点

- 灯体结构紧凑，轻巧易携，布灯轻松。
- 支持两种控制：2.4GHz 无线控制 / 蓝牙控制。
- 功率强劲，光源稳定，自由调节，调节范围为 0% -100%。
- DC 电源供电抑或 V 口锂电池供电，室内室外两用。
- 8 种可自定义光效，亮度轻松调整，模拟真实光效。
- 适配器、控制盒、灯体分离设计，科学散热，操作便捷。
- 拥有 360° U 型支架，配合标准保荣口及伞孔，提供更多光效可能性。
- 标配箱包，安全系数高，合理隔层，便于外出携带。

警告

- △请勿直视光源。
- △本灯具仅供专业使用。
- △请勿让儿童接触本产品。
- △使用前请将灯头保护罩取下。
- △请勿放置在超过 40°C 的高温环境中。
- △请勿将光源对准人的眼睛，以免造成伤害。
- △请使用本厂原装电源线，因使用非本厂电源线导致产品损坏，概不在本厂维修范围内。
- △本产品不能防水，请保持干燥，请勿用湿手接触产品，亦不可将产品浸入水中或暴露于雨中。
- △请勿在化学品、可燃性气体或其他特殊物质附近使用 LED 灯。
- △本灯具光源仅可由制造商、其服务代理商或相关合格人员更换。倘灯泡损坏或热变形，应及时更换。

产品结构 (VL150II 灯体)

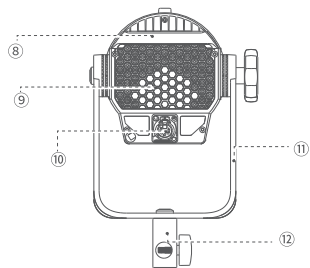
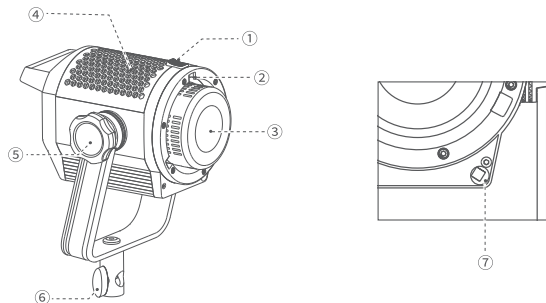

- | | |
|-----------|------------|
| 1. 卡口推制 | 7. 摄影伞孔 |
| 2. 保架卡口 | 8. 把手 |
| 3. LED 灯珠 | 9. 散热孔 |
| 4. 散热孔 | 10. 电源输入插口 |
| 5. 支架旋钮 | 11. U 型支架 |
| 6. 支架套筒旋钮 | 12. 支架套筒 |

控制盒 (VL150II)

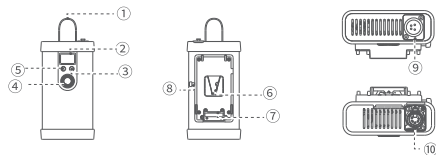

- | | |
|---------------|-------------|
| 1. 提手 | 6. V 口电池卡位 |
| 2. 显示屏 | 7. 电池插槽 |
| 3. FX/Mode 按键 | 8. 电池卡口推制 |
| 4. 调节转盘 | 9. DC 输入接口 |
| 5. 开关按键 | 10. DC 输出接口 |

控制盒 (VL200II、VL300II)

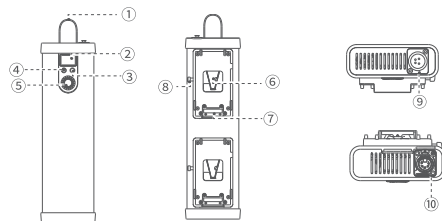

- | | |
|---------------|-------------|
| 1. 提手 | 6. 电池卡口推制 |
| 2. 显示屏 | 7. V 口电池卡位 |
| 3. FX/Mode 按键 | 8. 电池插槽 |
| 4. 开关按键 | 9. DC 输入接口 |
| 5. 调节转盘 | 10. DC 输出接口 |

物品清单

型号	物品清单
VL150II	灯体 *1、控制盒 VLC150II*1、反光罩 *1、保护罩 *1、电源连接线 *1、适配器 *1、电源线 *1、背夹扣带 *1、说明书 *1、便携包 CB62*1
VL200II	灯体 *1、控制盒 VLC200II*1、反光罩 *1、保护罩 *1、电源连接线 *1、适配器 *1、电源线 *1、背夹扣带 *1、说明书 *1、便携包 CB63*1
VL300II	灯体 *1、控制盒 VLC300II*1、反光罩 *1、保护罩 *1、电源连接线 *1、适配器 *1、电源线 *1、背夹扣带 *1、说明书 *1、便携包 CB64*1

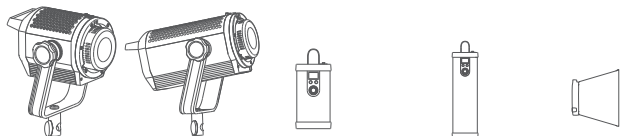

灯体 VL150II/VL200II 灯体 VL300II 控制盒 VLC150II 控制盒 VLC200II/VLC300II 反光罩



保护罩



电源连接线



适配器



背夹扣带



电源线



说明书

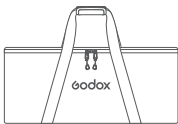

便携包

操作说明

1. 开机 / 关机

连接好适配器与控制盒后，长按开关按键实现开机 / 关机。

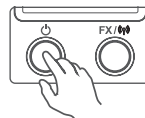

2. 模式选择：常亮模式 / FX 光效模式

常亮模式：主界面即为常亮模式，此时显示屏左下角不显示 FX。旋转调节转盘可调节亮度值，范围为 0% -100%。



FX 光效模式：长按 FX/☛ 按键，显示屏左下角显示 FX，表示此时处于光效模式。

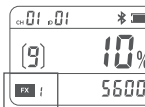

FX 号闪烁，旋转调节转盘可选择光效类型，一共 8 种。待选择好光效后，短按 FX/☛ 按键确定。确定光效后，再次短按 FX/☛ 按键可重新选择光效。

光效表 (8 种)

显示	FX1	FX2	FX3	FX4	FX5	FX6	FX7	FX8
场景	Flash 1	Flash 2	Flash3	Storm 1	Storm 2	Storm 3	坏灯泡	电视机

FX 号不闪烁，旋转调节转盘可调节亮度值，范围为 0% -100%。

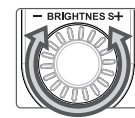

3. 2.4GHz 无线设置

频道 CH 设置：在常亮模式下，短按一次 FX/☛ 按键，频道 CH 号呈现闪烁状态，此时旋转调节转盘可以选择 01-32 组频道。选择完毕，待 CH 号不闪烁，表示自动退出频道 CH 设置。CH 号闪烁，也可再次短按四次 FX/☛ 按键退出频道 CH 设置。



组别 GR 设置: 在常亮模式下, 短按两次 FX/☞ 按键, 组别 GR 号呈现闪烁状态, 此时旋转调节转盘可以选择 A-F 或 0-9。选择完毕, 待组别 GR 号不闪烁, 表示自动退出组别 GR 设置。GR 号闪烁, 也可再次短按三次 FX/☞ 按键退出组别 GR 设置。

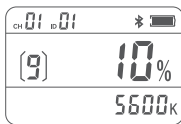

ID 设置: 在常亮模式下, 短按三次 FX/☞ 按键, ID 号呈现闪烁状态, 此时旋转调节转盘可以选择 01-99/OF。选择完毕, 待组别 ID 号不闪烁, 表示自动退出 ID 号设置。ID 号闪烁, 也可再次短按两次 FX/☞ 按键退出 ID 号设置。

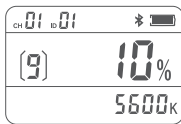

4. 功率选择 (VL300II)

在关机状态下, 同时按住开关按键和 FX/☞ 按键, 即可进入功率选择模式。旋转调节转盘可选择 200、250、300 三种功率。出厂功率默认为 300W。进入功率选择模式后, 5 秒无操作自动退出功率选择模式。



注: 此功能适用于大功率灯具输出时, 因某些 V 口电池无法输出相应功率导致电池进入保护状态, 从而不能继续使用该灯的情况。进入此模式, 可降低灯的输出功率, 让电池能带起负载, 避免出现电池保护 (仅 VL300II 支持功率选择)。

5. 蓝牙控制

查看蓝牙 MAC 码

在常亮模式下, 短按四次 FX/☞ 按键, 蓝牙图标和蓝牙 MAC 码显示, 表示处于蓝牙设置界面中。



蓝牙重置

进入蓝牙设置界面后, 长按 FX/☞ 按键, 蓝牙图标呈现闪烁状态, 表示蓝牙正在重置中。蓝牙图标闪烁结束, 表示蓝牙重置完毕。重置完毕后 10 秒无操作, 自动退出蓝牙设置界面。也可短按 FX/☞ 按键退出蓝牙设置界面。

APP 下载

直接扫二维码即可下载“Godox Light”手机 APP。(安卓和苹果系统都可以使用)
具体操作请参考手机 APP“帮助”手册, 里面有详情教程。



注: 首个移动设备 (手机或平板电脑) 可直接使用 APP 操控灯体。更换其他移动设备 (手机或平板电脑) 时, 灯体需进行蓝牙重置后, 方可正常使用 APP 连接。

高温警示

当灯体处于高温时, 显示屏色温值变为“HP”, 此时灯体可以正常控制。

当灯体温度过于高温时, 灯体光线消失, 显示屏上“HP”出现闪烁。

当灯体从过于高温状态转为正常温度状态时, 显示屏上“HP”变为色温值, 灯体恢复亮度。

照度数据

VL150II					
色温	测试条件	照度单位	1m	2m	3m
5600K	裸灯	lux	6100	1700	810
		fc	570	160	76.0
	带标罩	lux	76000	16000	5400
		fc	7000	1500	500
VL200II					
色温	测试条件	照度单位	1m	2m	3m
5600K	裸灯	lux	7400	2100	1100
		fc	700	190	100
	带标罩	lux	88900	19000	8000
		fc	8300	1800	750

VL300II					
色温	测试条件	照度单位	1m	2m	3m
5600K	裸灯	lux	11600	3500	1700
		fc	1100	300	160
	带标罩	lux	90000	20900	8800
		fc	8400	1950	820

* 上述测试皆在灯体 100%亮度下进行。

规格参数

型号	VL150II	VL200II	VL300II
适配器输入	AC100V-240V 50/60Hz 2A	AC100V-240V 50/60Hz 3.9A	AC100V-240V 50/60Hz 4.3A
灯体输入	35V===4.3A	47.8V===4.2A	50V===6A
V 口电池供电	标准电压 14.8V(另购)		
最大功率	165W	215W	320W
色温	5600±200K		
频道	32 个		
组别	16 组 (A,B,C,D,E,F,0-9)		
ID 号	99 个		
CRI	≥ 96		
TLCI	≥ 96		
调光范围	0% -100%		
工作环境温度	-10°C -40°C		
U 型支架调节角度	0° -360°		
尺寸	灯体: 270mm*175mm*212mm 控制盒: 114mm*59mm*258mm	灯体: 270mm*175mm*212mm 控制盒: 60mm*114mm*426mm	灯体: 272mm*176mm*292mm 控制盒: 60mm*114mm*426mm
净重 (≈)	灯体: 1.72kg 控制盒: 0.7kg	灯体: 1.77kg 控制盒: 1.19kg	灯体: 2.78kg 控制盒: 1.2kg

* 规格和参数如有变更, 恕不另行通知。

本设备包含型号核准代码为 :CMIITID:2020DP13510, 为该产品的无线电发射模块。

Safety Instructions and Attentions

First of all, as the most basic principle: This product is a professional lighting set equipment and should be used by professional lighting engineers or under the guidance of professionals. Basic safety attentions must always be followed during use, as follows:

1. Before use, please read and understand these instructions and attentions.
2. Professional lighting is prohibited for children. When children are near, parents or accompanying persons must supervise closely to prevent children from personal injury due to collision with lamps or private use of lamps.
3. This lighting product is not ordinary lighting product and cannot be used for general lighting. Anyone who has suffered eye damage or has sensitive eyes should avoid using this product.
4. When the lamp is on, it must be used with care. Do not touch high-temperature parts, such as LED lamp beads, to avoid burns.
5. When the lamp is on, it is forbidden to look directly at the lamp beads under any circumstances. Strong light should be used under the guidance of professional lighting engineers. Avoid prolonged exposure to strong light under any circumstances. If eye discomfort, please turn off the lamp in time, suspend use, and see a doctor immediately.
6. If the lamp bead is damaged or deformed by heat, stop using this equipment, and contact the manufacturer, service agent or qualified maintenance personnel to replace the lamp bead in time to avoid accidents.
7. This product is only suitable for use in -10°C to 40°C operating environment and normal humidity environment.
8. Do not use damaged equipment or accessories, and wait for professional maintenance personnel to check and repair to confirm being normal before use.
9. During using, if the casing of this product is broken due to being dropped, squeezed or subjected to strong impact, please do not use it, so as to avoid electric shock injury due to contact with internal electronic components.
10. If an extension cord is required, please use an extension cord with a current rating greater than or equal to that of the equipment. If an extension cord is rated less than the equipment, overheating may result.
11. Some products have long power cords, please place the power cords properly and keep them in a safe place. Avoid contacting the power cord with overheating surfaces, avoid improper placement that could cause pulling damage, or trip on-site personnel. Please use the certified power cord from the original manufacturer. If the product is damaged by using a non-certified power cord, it will not be repaired by our factory.

12. Be sure to unplug equipment from the power outlet before cleaning and repairing. When not in use, do not pull the power cord to unplug the equipment. For normal power-off, please hold both ends of the plug of the equipment with your hands and pull the plug out of power outlet. This equipment needs to be connected to a grounded outlet.
13. This equipment is not waterproof, please keep it dry and do not immerse it in water or other liquids. The equipment should be installed in a dry and ventilated place, and avoid using it in rainy, humid, dusty or overheated environments. Do not place any objects on the lamp or let liquid flow into the lamp to avoid accidents.
14. Do not disassemble the product without permission. If the product fails, it must be checked and repaired by authorized maintenance personnel.
15. Before storing, make sure that the equipment has cooled down completely. For storage, unplug the power cord from the equipment. The equipment should be placed in the carrying case or in a ventilated dry place.
16. Do not place equipment near flammable and volatile solvents such as alcohol and gasoline.
17. Do not use accessories that are not recommended by our factory to avoid fire, electric shock or personal injury.
18. When cleaning, do not wipe it with a damp cloth, please use a dry cloth or a soft cloth to wipe the dirt of the equipment.
19. Please take off the protective cover before using.
20. This product complies with ROHS, CE, and FCC certification, please refer to the relevant national standards for use and operation.
21. The safety instructions are formulated according to the strict testing of the factory, and the design and specifications of the equipment are subject to change without prior notice. For latest product information, please check the GODOX website and view latest electronic instruction.
22. Some products have built-in lithium batteries. Please use specified chargers, and use them within a proper range of the specified voltage and temperature according to the correct operating instructions.
23. Some products are battery powered. Do not use any batteries, power sources or accessories not specified in the instructions for such products. Keep batteries and other accessories out of the reach of children and infants. In the instance that a child or infant swallows a battery or accessory, immediate emergency medical attention is required. If the battery leaks, becomes discolored, deformed, emits smoke, or emits an abnormal odor, remove it immediately. Be careful during removal to avoid burns. Continued use could result in fire, electric shock, or burns. Do not use any deformed or modified batteries. Do not disassemble or modify this product or battery. Do not heat

or solder the battery. Keep the battery away from fire or water. Do not incorrectly insert the positive and negative ends of batteries, or mix old and new batteries or batteries of different types together.

24. One-year warranty period, accessories such as consumable batteries, adapters, power cords, etc. are not covered by this warranty.
25. If it is found that the equipment is repaired without authorization, the one-year warranty period will be cancelled and relevant fees will be charged for maintenance.
26. Machine failures caused by non-standard operation are not covered by the warranty.

keep these instructions!

Foreword

Thank you for purchasing this Godox Product!

VLII series LED video lights VL150II, VL200II and VL300II are featured with scientific heat dissipation design, separated adapter, controller and light body, high security coefficient, strong power, stable light source, ultra-high CRI and powerful performance, quite suitable for shooting scenes such as children photography, studio shooting, interview lighting, still life shooting and video shooting. It supports Bluetooth remote control through "Godox Light" APP, and wireless brightness adjustment through optional Godox RC-A6 remote control.

Please read this manual carefully before using to make sure the correct operation and exert the optimum function.

Main Feature

- Compact structure, lightweight and portable
- Support 2.4GHz wireless control and Bluetooth control
- Strong power and stable light source, brightness adjustable from 0% to 100%
- DC power supply or V-port lithium battery power supply, support both indoor and outdoor using
- 8 customized light effects and convenient operation
- Separated adapter, controller and light body enable scientific heat dissipation
- 360° U-type bracket, standard Bowens mount and umbrella hole
- Attached carry bag makes it conveniently portable.

Warning

- ⚠ Do not look directly at the light source.
- ⚠ The luminaire is intended for professional use only.
- ⚠ Keep out of reach of children.
- ⚠ Please take off the lamp cover before using.
- ⚠ Do not leave or store the product if the ambient temperature reads over 40°C.
- ⚠ Do not fire directly against human eyes as it may cause visual impairment.
- ⚠ Please use the original power cable, damages caused by using other cables will invalidate the warranty.
- ⚠ As this product do not have waterproof function, please take measures of waterproof in rainy or damp environment.
- ⚠ Always keep this product dry. Do not use in rain or in damp conditions.
- ⚠ Do not use the product in the presence of flammable gases, chemicals and other similar materials.
- ⚠ The light source contained in this luminaire shall only be replaced by the manufacturer or his service agent or a similar qualified person.
- ⚠ Do not disassemble. Should repairs become necessary, this product must be sent to an authorized maintenance center.
- ⚠ The lamp shall be changed if it has become damaged or thermally deformed.

Structure of Product

VL150II Light Body

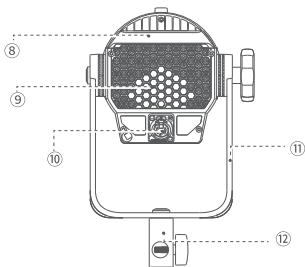
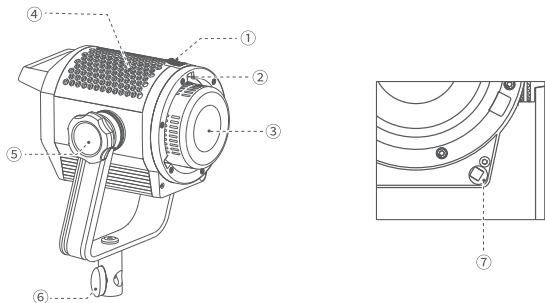

- | | |
|---------------------------|------------------------|
| 1. Accessory Locking Ring | 7. Umbrella Input |
| 2. Bowens Mount | 8. Handle |
| 3. LED Beads | 9. Thermovent |
| 4. Thermovent | 10. Power Input Socket |
| 5. Bracket Locking Ring | 11. U-type Bracket |
| 6. Bracket Sleeve Ring | 12. Bracket Sleeve |

VL150II Controller

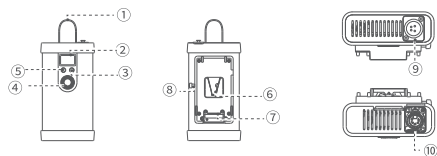

- | | |
|-------------------|-------------------------|
| 1. Handle | 6. V-port Battery Slot |
| 2. LCD Panel | 7. Battery Compartment |
| 3. FX/Mode Button | 8. Battery Locking Ring |
| 4. Adjust Dial | 9. DC Input Port |
| 5. Power Switch | 10. DC Output Port |

VL200II/VL300II Controller

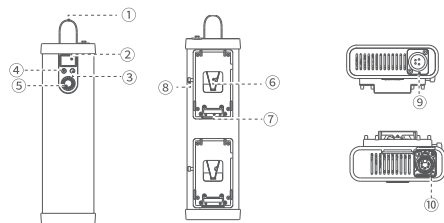

- | | |
|-------------------|-------------------------|
| 1. Handle | 6. Battery Locking Ring |
| 2. LCD Panel | 7. V-port Battery Slot |
| 3. FX/Mode Button | 8. Battery Compartment |
| 4. Power Switch | 9. DC Input Port |
| 5. Adjust Dial | 10. DC Output Port |

Included Items

Model	Included Items
VL150II	VL150II*1, Controller VLC150II*1, Reflector *1, Lamp cover *1, Connect cord*1, Adapter *1, Power cord *1, Back clip *1, Instruction Manual*1, Carry Bag CB62*1
VL200II	VL200II *1, Controller VLC200II*1, Reflector *1, Lamp cover *1, Connect cord*1, Adapter *1, Power cord *1, Back clip *1, Instruction Manual*1, Carry Bag CB63*1
VL300II	VL300II*1, Controller VLC300II*1, Reflector *1, Lamp cover *1, Connect cord*1, Adapter *1, Power cord *1, Back clip *1, Instruction Manual*1, Carry Bag CB64*1

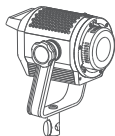

Light body VL150II/VL200II

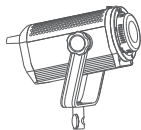

Light body VL300II



Controller VLC150II



Controller VLC200II
VLC300II



Reflector



Lamp cover



Connect cord



Adapter



Power cord



Back clip



Instruction Manual

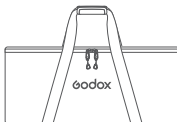

Carry Bag

Operation Instruction

1. Power on/off

Connect the adapter and controller, long press the Power Switch to power the LED light on or off.

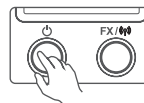

2. Mode selection: Constant on mode/FX mode

Constant on mode: The main interface is constant on mode, while the FX icon is not displayed on the left bottom of panel. Turn the adjust dial for light brightness to change the value from 0% to 100%.

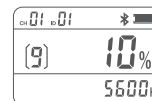

FX mode: Long press FX/ button to make the FX displayed on the left bottom of panel, it is FX icon mode.



When the FX icon flashes, turn the adjust dial to select among the 8 light effects, then short press the FX/ button to confirm. Short press the FX/ button again can reselect the light effect.

Light effects table (8 types)

Display	FX1	FX2	FX3	FX4	FX5	FX6	FX7	FX8
Scenes	Flash 1	Flash 2	Flash	Storm 1	Storm 2	Storm 3	Broken bulb	TV

When the FX icon stops flashing, turn the adjust dial for light brightness to change the value from 0% to 100%.



3. 2.4GHz wireless setting

CH setting: Short press the FX/ button once to make the CH icon flashes, then turn the adjust dial to choose among 01 to 32 channels. When the CH icon stops flashing, it means CH setting completed and automatically exited, while the CH icon flashes means short pressing FX/ button 4 times can also automatically exit CH setting.

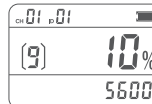

GR setting: Short press the FX/🔊 button twice to make the GR icon flashes, then turn the adjust dial to choose among A to F or 0 to 9 groups. When the GR icon stops flashing, it means GR setting completed and automatically exited, while the GR icon flashes means short pressing FX/🔊 button 3 times can also automatically exit GR setting.

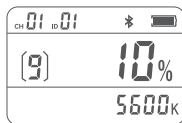

ID setting: Short press the FX/🔊 button three times to make the ID icon flashes, then turn the adjust dial to choose among 01 to 99 IDs or OF. When the ID icon stops flashing, it means ID setting completed and automatically exited, while the ID icon flashes means short pressing FX/🔊 button twice can also automatically exit ID setting.

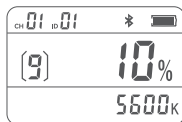

4. Power option(VL300II)

Press the power switch and FX/🔊 button at the same time in power off status to enter power option mode. Turn the adjust dial to choose power from 200, 250 and 300. The power is 300W by default. It will exit from this mode automatically without operation for 5 seconds.



Note: This function is used for the situation that the battery enter protection states and cannot work due to some v-port battery doesn't output the corresponding power in strong power output. When enter this mode, the output power of the light can be decreased and the battery can be loaded instead of being protected (this function only applies to VL300II).

5. Bluetooth control Check Bluetooth MAC code

Check Bluetooth MAC code

Short press the FX/🔊 button four times to make the Bluetooth icon and MAC code displayed, it is in Bluetooth setting interface.



Bluetooth reset

Long press the FX/🔊 button in Bluetooth setting interface to make the Bluetooth icon flashes, it means the Bluetooth is resetting. When the Bluetooth icon stops flashing means Bluetooth resetting is completed. It will exit from this mode automatically without operation for 10 seconds, short press the FX/🔊 button to exit is also available.

APP download

Scan the QR code to download the "Godox Light" mobile app. (It can be used on both Android and Apple systems) For specific operations, please refer to the "Help" manual of the mobile APP, which contains detailed tutorials.



Note: The first mobile device (mobile phone or tablet) can directly use the APP to control the light body. When replacing other mobile devices (mobile phones or tablets), the lamp body can be connected normally after Bluetooth reset.

Over-temperature Warning

When the light body is at a high temperature, the CCT value on the LCD panel turns to "HP", the light body still works normally.

When the light body is over-temperature, the light turns out, and "HP" flashes on the LCD panel.

When the light body changes from over-temperature state to a normal temperature state, "HP" on the LCD panel turns to the CCT value, and the light body restores its lighting.

Illuminance data

VL150II					
CCT	Testing Conditions	Illuminance Unit	1m	2m	3m
5600K	bare lamp	lux	6100	1700	810
		fc	570	160	76.0
	with reflector	lux	76000	16000	5400
		fc	7000	1500	500
VL200II					
CCT	Testing Conditions	Illuminance Unit	1m	2m	3m
5600K	bare lamp	lux	7400	2100	1100
		fc	700	190	100
	with reflector	lux	88900	19000	8000
		fc	8300	1800	750

VL300II

CCT	Testing Conditions	Illuminance Unit	1m	2m	3m
5600K	bare lamp	lux	11600	3500	1700
		fc	1100	300	160
	with reflector	lux	90000	20900	8800
		fc	8400	1950	820

* All the above tests are based on the condition of 100%brightness.

Technical Data

Model	VL150II	VL200II	VL300II
Adapter Input	AC100V-240V 50/60Hz 2A	AC100V-240V 50/60Hz 3.9A	AC100V-240V 50/60Hz 4.3A
Light Body Input	35V===4.3A	47.8V===4.2A	50V===6A
V-port battery	Standard voltage:14.8V (optional)		
Max. Power	165W	215W	320W
CCT Range	5600±200K		
CH	32		
GR	16 groups (A,B,C,D,E,F,0-9)		
ID	99		
CRI	≥96		
TLCI	≥96		
Brightness Adjustment Range	0% -100%		
Working Temperature Range	-10°C -40°C		
U-type Bracket Adjustable Angle	0°-360°		
Dimensions	Light Body: 270mm*175mm*212mm Controller: 114mm*59mm*258mm	Light Body: 270mm*175mm*212mm Controller: 60mm*114mm*426mm	Light Body: 272mm*176mm*292mm Controller: 60mm*114mm*426mm
Net Weight(≈)	Light Body: 1.72kg Controller: 0.7kg	Light Body: 1.77kg Controller: 1.19kg	Light Body: 2.78kg Controller: 1.2kg

* Product design and specifications are subject to change without notice.

FCC Statement

This device complies with part 15 of the FCC Rules. Operation is subject to the following two conditions:

- (1) This device may not cause harmful interference, and
- (2) this device must accept any interference received, including interference that may cause undesired operation

Any Changes or modifications not expressly approved by the party responsible for compliance could void the user's authority to operate the equipment

Note: This equipment has been tested and found to comply with the limits for a Class B digital device, pursuant to part 15 of the FCC Rules. These limits are designed to provide reasonable protection against harmful interference in a residential installation. This equipment generates uses and can radiate radio frequency energy and, if not installed and used in accordance with the instructions, may cause harmful interference to radio communications. However, there is no guarantee that interference will not occur in a particular installation. If this equipment does cause harmful interference to radio or television reception, which can be determined by turning the equipment off and on, the user is encouraged to try to correct the interference by one or more of the following measures:

- Reorient or relocate the receiving antenna.
- Increase the separation between the equipment and receiver.
- Connect the equipment into an outlet on a circuit different from that to which the receiver is connected.
- Consult the dealer or an experienced radio/TV technician for help

This equipment complies with FCC radiation exposure limits set forth for an uncontrolled environment. This equipment should be installed and operated with minimum distance 20cm between the radiator & your body.

⚠ Warning

VL150II

Operating frequency:2412.99MHz – 2464.49MHz(2.4G only receive)/2402MHz – 2480MHz(BT)

Maximum EIRP Power: -0.81dBm

VL200II VL300II

Operating frequency:2412.99MHz – 2464.49MHz(2.4G only receive)/2402MHz – 2480MHz(BT)

Maximum EIRP Power: 6.83dBm

Declaration of Conformity

GODOX Photo Equipment Co.,Ltd. hereby declares that this equipment are in compliance with the essential requirements and other relevant provisions of Directive 2014/53/EU. In accordance with Article 10(2) and Article 10(10), this product is allowed to be used in all EU member states.For more information of DoC, Please click this web link:

<https://www.godox.com/eu-declaration-of-conformity>

The device complies with RF specifications when the device used at 0mm from your body.

产品保修

尊敬的用户，本保修卡是申请保修服务的重要凭证，请您配合销售商填写并妥善保管，谢谢！

产品信息	型号	产品条码
用户信息	姓名	联系电话
	通讯地址	
销售商信息	名称	
	联系电话	
	通讯地址	
	销售日期	
备注		

注：此表应由销售商盖章确认。

产品信息

本文件适用于相关《产品保修信息》（见后面说明）所列产品，其他非属此范围的产品或部件（如促销品、赠品及其他出厂后附加的部件等）不在此保修承诺内。

保修期

产品及部件的相应保修期按相关的《产品保修信息》执行。保修期自产品首次购买日起算，购买日以购买产品时保修卡登记日期为准。

如何获得保修服务

您可直接与产品销售商或授权服务机构联系，也可拨打神牛产品售后服务电话，与我们联系，我们的服务人员为您安排服务。申请保修时，您应提供有效的保修卡作为保修凭证，方可获得保修。如您不能提供有效的保修卡，则在我们可确认产品或部件属于保修范围的情况下，也可以为您提供保修，但这不作为我们的义务。

不适用保修的情况

如产品存在下列情况，本文件项下的保证和服务将不适用 ①产品或部件超过相应保修期；②错误或不适当使用、维护或保管导致的故障或损坏，如：不当搬运；非按产品合理预期用途使用；③当插拔外接设备；跌落或外力挤压；接触或暴露于不适当温度、溶剂、酸碱、水浸或潮湿环境；④由非神牛授权机构或人员安装、修理、更改、添加或拆卸造成的故障或损坏；⑤产品或部件原有识别信息被修改变更或除去；⑥无有效保修卡；⑦使用非法授权、非标准或非公开发行的软件造成的故障或损坏；⑧因不可抗力或意外事件造成的故障或损坏；⑨其他非因产品本身质量问题导致的故障或损坏。遇上述情况，您应向相关责任方寻求解决，神牛对此不承担任何责任。因非在保修期或保修范围内的部件、附件或软件导致产品不能正常使用的，不是保修范围内的故障。产品使用过程中正常的脱色，磨损和消耗，不是保修范围内的故障。

产品保修和服务支持信息

产品的保修期和服务类型按以下《产品保修信息》执行：

产品类别	选件名称	保修期（月）	保修服务类型
部件	电路板	12	客户送修
	电池	3	客户送修
	充电器带电性能的部件	12	客户送修
其他	如闪光管、造型灯泡、外壳、保护罩、锁紧装置、包装、电源线、同步线等。	无	无保修

神牛产品售后服务电话 0755-29609320-8062

Warranty

Dear customers, as this warranty card is an important certificate to apply for our maintenance service, please fill in the following form in coordination with the seller and safe-keep it. Thank you!

Product Information	Model	Product Code Number
	Name	Contact Number
	Address	
Customer Information	Name	
	Contact Number	
	Address	
	Date of Sale	
Seller Information		
Name		
Contact Number		
Address		
Date of Sale		
Note		

Note: This form shall be sealed by the seller.

Applicable Products

The document applies to the products listed on the Product Maintenance Information (see below for further information). Other products or accessories (e.g. promotional items, giveaways and additional accessories attached, etc.) are not included in this warranty scope.

Warranty Period

The warranty period of products and accessories is implemented according to the relevant Product Maintenance Information. The warranty period is calculated from the day(purchase date) when the product is bought for the first time, And the purchase date is considered as the date registered on the warranty card when buying the product.

How to Get the Maintenance Service

If maintenance service is needed, you can directly contact the product distributor or authorized service institutions. You can also contact the Godox after-sale service call and we will offer you service. When applying for maintenance service, you should provide valid warranty card. If you cannot provide valid warranty card, we may offer you maintenance service once confirmed that the product or accessory is involved in the maintenance scope, but that shall not be considered as our obligation.

Inapplicable Cases

The guarantee and service offered by this document are not applicable in the following cases: ① . The product or accessory has expired its warranty period; ② .Breakage or damage caused by inappropriate usage, maintenance or preservation, such as improper packing, improper usage, improper plugging in/out external equipment, falling off or squeezing by external force, contacting or exposing to the improper temperature, solvent, acid, base, flooding and damp environments, etc; ③ . Breakage or damage caused by non-authorized institution or staff in the process of installation, maintenance, alternation, addition and detachment; ④ . The original identifying information of product or accessory is modified, alternated, or removed; ⑤ . No valid warranty card; ⑥ . Breakage or damage caused by using illegally authorized, nonstandard or non-public released software; ⑦ . Breakage or damage caused by force majeure or accident; ⑧ . Breakage or damage that could not be attributed to the product itself. Once met these situations above, you should seek solutions from the related responsible parties and Godox assumes no responsibility. The damage caused by parts, accessories and software that beyond the warranty period or scope is not included in our maintenance scope. The normal discoloration, abrasion and consumption are not the breakage within the maintenance scope.

Maintenance and Service Support Information

The warranty period and service types of products are implemented according to the following Product Maintenance Information:

Product Type	Name	Maintenance Period(month)	Warranty Service Type
Parts	Circuit Board	12	Customer sends the product to designated site
	Battery	3	Customer sends the product to designated site
	Electrical parts e.g.battery charger, etc.	12	Customer sends the product to designated site
Other Items	Flash tube, modeling lamp, lamp body, lamp cover, locking device, package,power cord, sync cable, etc.	No	Without warranty

Godox After-sale Service Call 0755-29609320-8062

合格证
QC PASS



Wechat
Official Account
神牛微信公众号

深圳市神牛摄影器材有限公司

地址: 深圳市宝安区福海街道塘尾社区耀川工业区厂房2栋 电话: 0755-29609320(8062)
传真: 0755-25723423 邮箱: godox@godox.com

GODOX Photo Equipment Co.,Ltd.

Add: Building 2,Yaochuan Industrial Zone,Tangwei Community, Fuhai Street, Bao'an District, Shenzhen 518103,China Tel:+86-755-29609320(8062) Fax:+86-755-25723423 E-mail:godox@godox.com

www.godox.com

Made in China | 705-VL1520-01

