

MLP19K MLP26K MLP36K

投影筒套装 Projection Kit

说明手册
Instruction Manual

物料清单

MLP19K



投影筒
×1
(含 19° 规格镜头)



说明书
×1



投影片夹
×1



投影片组
×1



色片夹
×1



箱包 CB91
×1

MLP26K



投影筒
×1
(含 26° 规格镜头)



说明书
×1



投影片夹
×1



投影片组
×1



色片夹
×1



箱包 CB91
×1

MLP36K



投影筒
×1
(含 36° 规格镜头)



说明书
×1



投影片夹
×1



投影片组
×1



色片夹
×1



箱包 CB91
×1

前言

感谢您购买神牛产品！
神牛全新推出一系列神牛卡口投影筒，一共三款：MLP19K、MLP26K、MLP36K。MLP19K 内含 19° 可拆卸镜头，MLP26K 内含 26° 可拆卸镜头、MLP36K 内含 36° 可拆卸镜头。
MLP 系列投影筒属于便捷控光工具，搭配神牛卡口 LED 摄影灯，它可以是聚光灯、也可以是追光灯、还能是投影灯；能够为用户提供聚光、追光、光束切割、光学变焦、光束投影、光束造型等特色光效。

部件名称

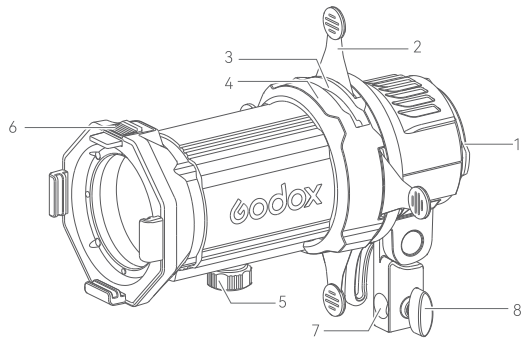

1. 神牛卡口
2. 切光片卡槽
3. 光阑卡槽
4. 投影片卡槽
5. 对焦旋钮
6. 色片夹安装装置
7. 转接座
8. 固定旋钮

2. 安装神牛卡口 LED 摄影灯 (以 ML60 为例)

将 LED 摄影灯神牛卡口对准投影筒的卡口插入，接着向右旋转拧紧即可。

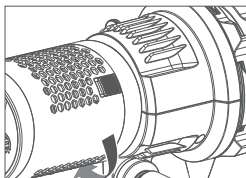

3. 拆卸神牛卡口 LED 摄影灯 (以 ML60 为例)

将 ML60 的卡口推制往后推动，接着向左旋转松开即可完成拆卸。

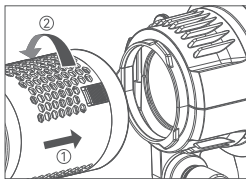

4. 安装 Gobo 片

将所需 Gobo 片放进 Gobo 投影片夹中，接着将 Gobo 投影片夹放进投影片卡槽；稍微用力往下压，投影片夹便插入投影片卡槽。

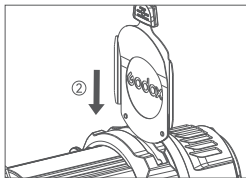
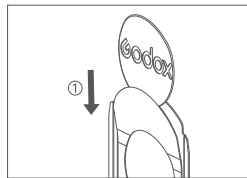

另购附件

19°投影镜头MLP-01、26°投影镜头MLP-02、36°投影镜头MLP-03
光阑MLP-ID

安装及其使用

1. 安装到三脚架上

将投影筒转接座插入三脚架顶部，调至所需的拍摄角度，最后旋紧固定旋钮。
注：三脚架为另购物品，不包含在套装内。

规格参数

名称	尺寸	重量
投影筒 (包含镜头)	237mm*219mm*277mm	≈1.43kg
19° 镜头	131mm*118mm*150mm	≈1.22kg
26° 镜头	131mm*118mm*150mm	≈1.05kg
36° 镜头	131mm*118mm*150mm	≈0.99kg

照度数据

MLP 投影筒，使用不同镜头的照度数据 (搭配 ML60)

色温	测试条件	照度单位	2m	3m	5m
5600K	裸灯	lux	≈618	≈286	≈109
		fc	≈57.5	≈26.5	≈10.1
	19° 镜头	lux	≈8300	≈3560	≈1230
		fc	≈793	≈328	≈113
	26° 镜头	lux	≈5520	≈2410	≈840
		fc	≈523	≈220	≈77
	36° 镜头	lux	≈2970	≈1320	≈462
		fc	≈283	≈120	≈42.6

以上测试皆在灯体 100% 亮度且投影筒设为聚光状态下进行。
摄影灯 ML60 需另购。

不同镜头光斑均匀度

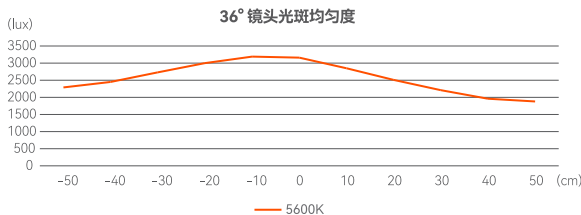
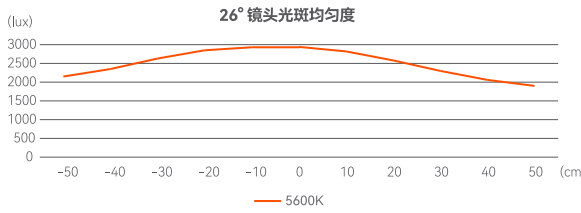
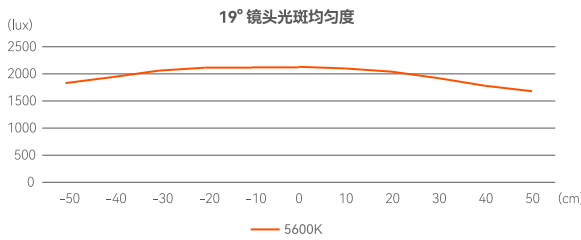

注：使用的摄影灯为 ML60 (另购)三个镜头所测光斑直径为 1m,5600K 为色温值。

产品保修

尊敬的用户，本保修卡是申请保修服务的重要凭证，请您配合销售商填写并妥善保管，谢谢！

产品信息	型号	产品条码
用户信息	姓名	联系电话
	通信地址	
销售商信息	名称	
	联系电话	
	通信地址	
	销售日期	
备注		

注：此表应由销售商盖章确认。

适用产品

本文件适用于相关《产品保修信息》(见后面说明)所列产品，其他非属此范围的产品或部件(如促销品、赠品及其他出厂后附加的部件等)不在此保修承诺内。

保修期

产品及部件的相应保修期按相关的《产品保修信息》执行。保修期自产品首次购买日起算，购买日以购买产品时保修卡登记日期为准。

如何获得保修服务

您可直接与产品销售商或授权服务机构联系，也可拨打神牛产品售后服务电话，与我们联系，由我们的服务人员为您安排服务。申请保修时，您应提供有效的保修卡作为保修凭证，方可获得保修。如您不能提供有效的保修卡，则在我们确认产品或部件属于保修范围的情况下，也可以为您提供保修，但这不作为我们的义务。

不适用保修的情况

如产品存在下列情况，本文件项下的保证和服务将不适用 ①产品或部件超过相应保修期；②错误或不适当使用、维护或保管导致的故障或损坏，如：不当搬运；非按产品合理预期用途使用；不当插拔外接设备；跌落或外力挤压；接触或暴露于不当温度、溶剂、酸碱、水浸或潮湿环境；③由非神牛授权机构或人员安装、修理、更改、添加或拆卸造成的故障或损坏；④产品或部件原有识别信息被修改变更或删除；⑤无有效保修卡；⑥使用非合法授权、非标准或非公开发行的软件造成的故障或损坏；⑦因不可抗力或意外事件造成的故障或损坏；⑧其他非因产品本身质量问题导致的故障或损坏。遇上述情况，您应向相关责任方寻求解决，神牛对此不承担任何责任。因非在保修期或保修范围内的部件、附件或软件导致产品不能正常使用的，不是保修范围内的故障。产品使用过程中正常的脱色、磨损和消耗，不是保修范围内的故障。

产品保修和服务支持信息

产品的保修期和服务类型按以下《产品保修信息》执行：

产品类别	选件名称	保修期(月)	保修服务类型
部件	电路板	12	客户送修
	电池	3	客户送修
	充电器等带电性能的部件	12	客户送修
其他	如外壳、保护罩、锁紧装置、包装等。	无	无保修

神牛产品售后服务电话：0755-29609320-8062

Foreword

Thank you for purchasing!

Godox has dropped a new range of projection attachments with Godox-mount. There are 3 models in total which are MLP19K, MLP26K and MLP36K. They are equipped with 19°, 26° and 36° detachable lenses respectively.

The MLP series projection attachment is a portable light control tool. When paired with Godox-mount LED video light, it can function as a spotlight, follow spotlight, or projection light, offering users a variety of distinctive lighting effects such as spotlighting, follow spotlighting, beam cutting, optical zoom, beam projection, and beam shaping.

Parts

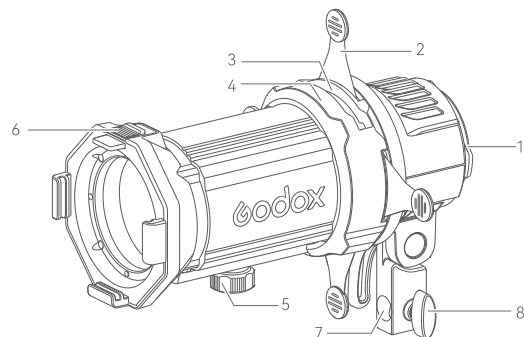

- | | |
|------------------------|-------------------------------|
| 1. Godox Mount | 5. Focusing Dial |
| 2. Shutter Blade Slot | 6. Color Effects Set Retainer |
| 3. Iris Diaphragm Slot | 7. Stand Adapter |
| 4. Gobo Holder Slot | 8. Locking Knob |

2. Installation of LED Light (Take ML60 as an example)

Insert the G-mount into the buckle of the projection attachment, then rotate right to tighten it.

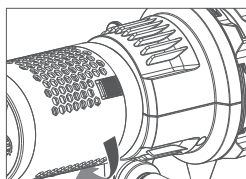

3. Disassembly of LED Light (Take ML60 as an example)

Pull the ML60 pusher backward, then turn it to the left to release it.

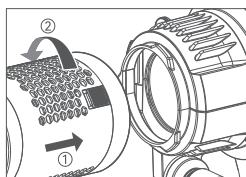

4. Installation of Gobo

Place the Gobo in the Gobo holder, then insert the Gobo holder into the slot, pressing down slightly until it is fully inserted.

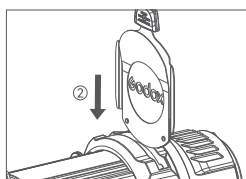
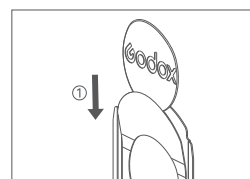

Beam Uniformity of Different Lens

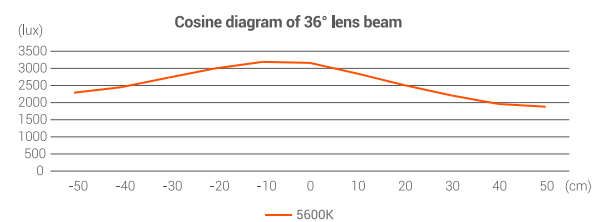
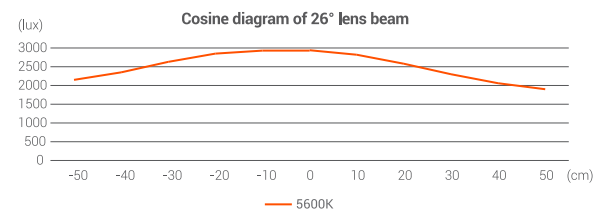
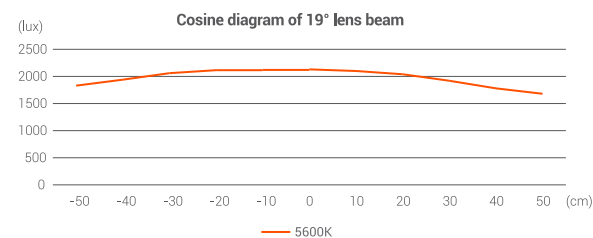

The video light used is ML60 (sold separately), and the measured spot diameters for the three lenses are 1meter, with a color temperature of 5600K.

Inapplicable Cases

The guarantee and service offered by this document are not applicable in the following cases: (1). The product or accessory has expired its warranty period; (2). Breakage or damage caused by inappropriate usage, maintenance or preservation, such as improper packing, improper usage, improper plugging in/out external equipment, falling off or squeezing by external force, contacting or exposing to the improper temperature, solvent, acid, base, flooding and damp environments, etc; (3). Breakage or damage caused by non-authorized institution or staff in the process of installation, maintenance, alternation, addition and detachment; (4). The original identifying information of product or accessory is modified, alternated, or removed; (5). No valid warranty card; (6). Breakage or damage caused by using illegally authorized, nonstandard or non-public released software; (7). Breakage or damage caused by force majeure or accident; (8). Breakage or damage that could not be attributed to the product itself. Once met these situations above, you should seek solutions from the related responsible parties and Godox assumes no responsibility. The damage caused by parts, accessories and software that beyond the warranty period or scope is not included in our maintenance scope. The normal discoloration, abrasion and consumption are not the breakage within the maintenance scope.

Maintenance and Service Support Information

The warranty period and service types of products are implemented according to the following Product Maintenance Information:

Product Type	Name	Maintenance Period(month)	Warranty Service Type
Parts	Circuit Board	12	Customer sends the product to designated site
	Battery	3	Customer sends the product to designated site
	Electrical parts e.g.battery charger, etc.	12	Customer sends the product to designated site
Other Items	Lamp body, lamp cover, locking device, package, etc.	No	Without warranty

Godox After-sale Service Call 0755-29609320-8062

Packing List

MLP19K

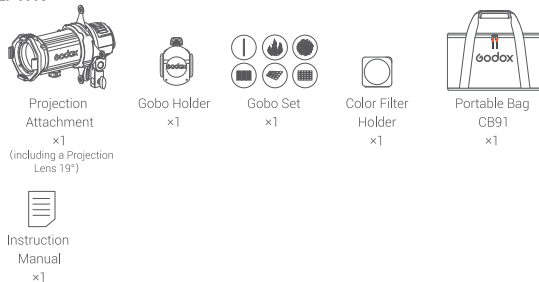

MLP26K

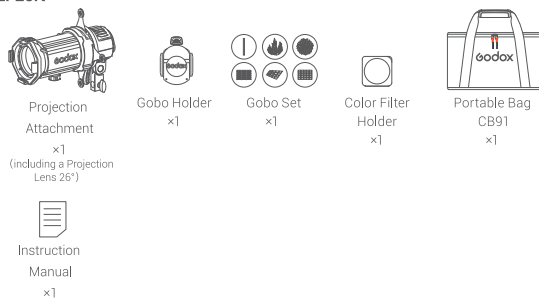

MLP36K

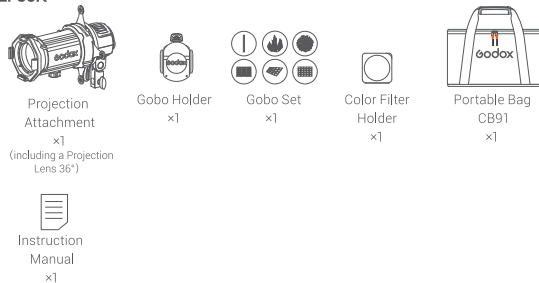

Optional Accessories

Projection Lens 19° MLP-01 Projection Lens 26° MLP-02 Projection Lens 36° MLP-03
Iris Diaphragm MLP-ID

Installation and Application

1. Mounting the Projection Attachment to a Tripod

Insert the stand adapter into the top of the tripod, adjust to the desired angle, and tighten the locking knob to secure it in place.

Note: Tripod is sold separately.

Technical Data

Name	Dimension	Weight
Projection Attachment (including lens)	237mm*219mm*277mm	≈1.43kg
Projection Lens 19°	131mm*118mm*150mm	≈1.22kg
Projection Lens 26°	131mm*118mm*150mm	≈1.05kg
Projection Lens 36°	131mm*118mm*150mm	≈0.99kg

Photometric Data

MLP projection attachments, photometric data using different lenses (with ML60)

CCT	Testing Condition	Unit	2m	3m	5m
5600K	Bare light	lux	≈618	≈286	≈109
		fc	≈57.5	≈26.5	≈10.1
	Projection Lens 19°	lux	≈8300	≈3560	≈1230
		fc	≈793	≈328	≈113
	Projection Lens 26°	lux	≈5520	≈2410	≈840
		fc	≈523	≈220	≈77
Projection Lens 36°	lux	≈2970	≈1320	≈462	
	fc	≈283	≈120	≈42.6	

The above tests were all conducted with the lamp at 100% brightness and the projection lens set to spotlight mode. Video light ML60 is available separately.

Warranty

Dear customers, as this warranty card is an important certificate to apply for our maintenance service, please fill in the following form in coordination with the seller and safe-keep it. Thank you!

Product Information	Model	Product Code Number
Customer Information	Name	Contact Number
	Address	
Seller Information	Name	
	Contact Number	
	Address	
	Date of Sale	
Note:		

Note: This form shall be sealed by the seller.

Applicable Products

The document applies to the products listed on the Product Maintenance Information (see below for further information). Other products or accessories (e.g. promotional items, giveaways and additional accessories attached, etc.) are not included in this warranty scope.

Warranty Period

The warranty period of products and accessories is implemented according to the relevant Product Maintenance Information. The warranty period is calculated from the day (purchase date) when the product is bought for the first time, And the purchase date is considered as the date registered on the warranty card when buying the product.

How to Get the Maintenance Service

If maintenance service is needed, you can directly contact the product distributor or authorized service institutions. You can also contact the Godox after-sale service call and we will offer you service. When applying for maintenance service, you should provide valid warranty card. If you cannot provide valid warranty card, we may offer you maintenance service once confirmed that the product or accessory is involved in the maintenance scope, but that shall not be considered as our obligation.

合格证
QC PASS



深圳市神牛摄影器材有限公司

地址: 深圳市宝安区福海街道塘尾社区耀川工业区厂房2栋
电话: 0755-29609320(8062) 传真: 0755-25723423 邮箱: godox@godox.com

GODOX Photo Equipment Co., Ltd.

Add: Building 2, Yaochuan Industrial Zone, Tangwei Community, Fuhai Street, Bao'an District, Shenzhen 518103, China
Tel: +86-755-29609320(8062) Fax: +86-755-25723423 E-mail: godox@godox.com

www.godox.com

Made in China | 705-MLP000-01

