

Godox

Godox

GODOX Photo Equipment Co.,Ltd.

Factory Add: 4th Floor of Building 1, 1st to 4th Floor of Building 2, 4th Floor of Building 3, 1st to 4th Floor of Building 4, Yaochuan Industrial Zone, Tangwei Community, Fuhai Street, Bao'an District, Shenzhen 518103, China

TEL: +86-(0)755-25701197,25726373 FAX: +86-(0)755-25723423 Email: godox@godox.com

www.godox.com

godoxglobal GODOX Global godoxphotoequipment GODOX Photo godoxofficial

KNOWLED™ CINEMATIC LIGHTING ECOSYSTEM



Knowledge Take You Further

At Godox, we have always been dedicated to providing a comprehensive range of lighting solutions for filmmakers and content creators. KNOWLED series, in particular, stands as a testament to our commitment to elevating the standards of professional production.

In the dynamic world of film and television production, lighting plays a pivotal role in shaping narratives, evoking emotions, and capturing moments in their full splendor. With KNOWLED cinematic lighting ecosystem, we empower filmmakers with the tools they need to bring their creative visions to life.



CONTENTS

05 • COB Light

MG2400Bi
MG1200Bi
M600D/M600Bi
M200D/M200Bi/M300D/M300Bi
M600R

27 • Focusing Light

S60/S60Bi

33 • Panel Light

P600Bi Hard
P600R Hard/P1200R Hard
P300R/P600R

45 • Flexible LED Mat

F200Bi/F400Bi/F600Bi

51 • Tube Light

TP2R/TP4R/TP8R

57 • Air Tube Light

AT200Bi

61 • Ambient Light

C5R/C7R/C10R

67 • Cine Lighting Reflector

LiteFlow 7/15/25/50/100

75 • Control System

KNOWLED APP

77 • Accessory

Projection Attachment GP19K/26K/36K
Projection Attachment VSA-19K/26K/36K
Fresnel Lens GF14/FLS8/FLS10
Scrim Flag SF6090/SF4560 Kit
Parabolic Softbox QR-P70/P90/P120
Softbox Series SB Series
Lighting Stands



KNOWLED™ COB LIGHTS



SPECS

Model	MG2400Bi	MG1200Bi	M600D/Bi	M200D/Bi/M300D/Bi
Luminance(with reflector)	4,650lux with GR45@10m(5600K)	149,000Lux with GR15 @3m(5600K)	M600D: 15,700Lux/M600Bi: 17,500Lux@3m(5600K)	M200D: 8,850Lux/M200Bi: 9,440Lux M300D: 8,980Lux/M300Bi: 12,900Lux@3m(5600K)
Color Version	Bi-color	Bi-color	Daylight/Bi-color	Daylight/Bi-color
CCT	2800K-6500K	2800K-6500K	D: 5600K/Bi: 2800K-6500K	D: 5600K/Bi: 2800K-6500K
Max. Power	2600W	1400W	740W/730W	230W/230W/330W/360W
Color Rendering	CQS≥95/CRI≥96/TLCl≥96	CQS≥94/CRI≥96/TLCl≥96/R15≥92/TM-30 RF≥92	CRI≥96/TLCl≥97	CRI≥96/TLCl≥97
Controls	CRMX/Ethernet/DMX/Removable panel/ App/On-board/Remoter	CRMX/Ethernet/DMX/Removable panel/ App/On-board/Remoter	DMX/On-board/App/Remoter	DMX/On-board/App/Remoter
Power Supply	AC	AC	AC/DC 48V/V-mount battery	AC/DC 48V/V-mount battery
Dimension				
Light Body	409*385*356mm	378*579*354mm	447.3*242.8*152.9mm/481.3*242.8*152.9mm	425.3*232.3*141.7mm
Controller	280*420*210mm	162*190*372mm	332.4*121.6*179.2mm	270.4*123.6*132mm
Weight				
Light Body	22kg	16kg	4.5kg/4.96kg	3.03kg/3.2kg/3.3kg/3.5kg
Controller	13kg	6.68kg	3.987kg/3.74kg	2.74kg/2.7kg/2.74kg/2.7kg

Bi-color LED Light | MG2400Bi



Bi-color LED Light | MG2400Bi



POWER
2600w
Power 2600W

IP54
Weather Resistance

2800K-6500K

G-Mount

4,410lux@10m
with 45° Reflector

MG2400Bi

- CCT: 2800-6500K
- 2600W power across all color temperatures
- CQS≥95, CRI≥96, TLCI≥96
- Controls: DMX & RDM, LumenRadio CRMX, Ethernet (sACN and ArtNet protocol), App control, on-board and removable panel
- Compatible with Godox G-Mount with a complete light shaping system
- IP54 weather resistance
- 0.1% stepless adjustment
- High efficient heat dissipation system
- 4 dimming curves
- 11 built-in FX effects
- 360° rotatable U-Type yoke
- 8-meters power cord and connecting cord

Bi-color LED Light | MG2400Bi



MG2400Bi

Light Body	×1	Protection Cover	×1
Yoke	×1	Safety Wire	×1
Controller	×1	Main Cable	×1
Antenna	×1	DC Cable	×1
Reflector	×1	Tying Rope	×1
Clamp	×1		



MG2400Bi K1 Kit

Light Body	×1	Safety Wire	×1
Yoke	×1	Main Cable	×1
Controller	×1	DC Cable	×1
Antenna	×1	Tying Rope	×1
Reflector	×1	Soft Case for Light Body SC18	×1
Clamp	×1	Soft Case for Accessory SC19	×1
Protection Cover	×1		



MG2400Bi K2 Kit

Light Body	×1	Protection Cover	×1
Yoke	×1	Safety Wire	×1
Controller	×1	Main Cable	×1
Antenna	×1	DC Cable	×1
Reflector	×1	Tying Rope	×1
Clamp	×1	Flight Case FC05	×1

Bi-color LED Light | MG2400Bi



Bi-color LED Light | MG1200Bi



Bi-color LED Light | MG1200Bi



POWER
1200w
Power 1200W

IP54
Weather Resistance

2800K-6500K

G-Mount

86,100lux@3m
with Fresnel

MG1200Bi

- CCT: 2800-6500K
- 1200W power across all color temperatures
- CQS≥94, CRI≥96, TLCI≥96, R15≥92, TM-30 Rf≥92
- Controls: DMX & RDM, LumenRadio CRMX, Ethernet (sACN and ArtNet protocol), App control, 2.4GHz remote, on-board and removable panel
- Compatible with Godox G-Mount with a complete light shaping system
- IP54 weather resistance
- 0.1% stepless adjustment
- High efficient heat dissipation system
- 4 dimming curves
- 11 built-in FX effects
- 360° rotatable U-Type yoke
- 8-meters power cord and connecting cord

Bi-color LED Light | MG1200Bi



Night-for-day lighting



Studio set lighting



Sunlight-through-windows simulation

Bi-color LED Light | MG1200Bi



MG1200Bi

Light Body	×1	Power Cable	×1
U-type Bracket	×1	Carry Bag	×1
Controller	×1	Controller Mounting Device PC01	×1
Antenna	×1	Light Protection Cover	×1
Steel Rope	×1	DC Connect Cable	×1
Reflector GR45	×1		



MG1200Bi K1 (3 reflectors included)

U-type Bracket	×1	DC Connect Cable	×1
Controller	×1	30° Reflector GR30	×1
Antenna	×1	45° Reflector GR45	×1
Steel Rope	×1	60° Reflector GR60	×1
Power Cable	×1	Soft Case SC01	×1
Controller Mounting Device PC01	×1	Reflector Case 1	×1
Light Protection Cover	×1		



MG1200Bi K2 (4 reflectors included)

Light Body	×1	DC Connect Cable	×1
U-type Bracket	×1	15° Reflector GR15	×1
Controller	×1	30° Reflector GR30	×1
Antenna	×1	45° Reflector GR45	×1
Steel Rope	×1	60° Reflector GR60	×1
Power Cable	×1	Soft Case SC01	×1
Controller Mounting Device PC01	×1	Reflector Case 2	×1
Light Protection Cover	×1		



MG1200Bi K3 (4 reflectors & hard case included)

Light Body	×1	DC Connect Cable	×1
U-type Bracket	×1	15° Reflector GR15	×1
Controller	×1	30° Reflector GR30	×1
Antenna	×1	45° Reflector GR45	×1
Steel Rope	×1	60° Reflector GR60	×1
Power Cable	×1	Hard Case HC01	×1
Controller Mounting Device PC01	×1	Reflector Case 2	×1
Light Protection Cover	×1		

Bi-color LED Light | MG1200Bi&MG2400Bi

Optional Purchase (for MG1200Bi & MG2400Bi)



GP26K
Projection Attachment
With 26° Lens



GP-Lens 19° (optional)



GP-Lens 36° (optional)



GF14
Fresnel Lens

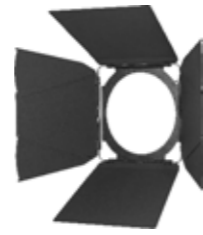

GF14B
Barndoor for Fresnel Lens



SC06
Soft Case for Fresnel



Yoke G2400BY01
(for MG2400Bi)

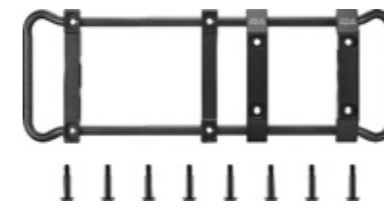

GP-SKID
Skid for GP (for MG2400Bi)



SC18
Soft Case for Light Body
(for MG2400Bi)



SC19
Soft Case for Accessory
(for MG2400Bi)



FC05
Flight Case
(for MG2400Bi)



GR15
15° Reflector



GR30
30° Reflector



GR45
45° Reflector



GR60
60° Reflector



RC-A6II
2.4GHz Remoter
(for MG1200Bi)



RC-R9II
2.4GHz Remoter
(for MG1200Bi)



RC11
Removable
Controller



GL3/GL4
Lantern Softboxes



GP3/GP4/GP5
Parabolic Softboxes



GS33/GS34/GS44
Rectangular Softboxes



GO4
Octa Softboxes



SC01
Soft Case (for MG1200Bi)



HC01
Hard Case (for MG1200Bi)



GP-QB
Quick-Lock Bracket (for MG2400Bi)

Projection Attachment GP Kit



GP19K/26K/36K Projector	×1	Portable Case	×1
Gobo Holder	×1	Lens	×1
Gobo Set	×1		

Bi-color LED Light | MG1200Bi&MG2400Bi

Optional Purchase for GP



Lens 19°



Lens 26°



Lens 36°



Iris Diaphragm GP-ID



Gobo Set GP-GS1



Gobo Set GP-GS2



Gobo Set GP-GS3



Gobo Set GP-GS4



Gobo Set GP-GS5



POWER
740w

Power 740W



Supporting V-mount
Battery



15,700Lux@3m
with Reflector



Bowens Mount

M600D

- 15,700 lux with reflector at 9.8'
- Top-notch control box
- CRI≥96, TLCI≥97
- Adjustable finely in 0.1% or quickly in 10% increments
- 4 dimming curves
- Supporting V-mount battery power supply
- Powerful cooling system
- Controls: DMX, App control, 2.4GHz remote, on-board
- 4 built-in FX effects
- Bowens mount for wide compatibility



POWER
730w

Power 730W



Supporting V-mount
Battery



15,700Lux@3m
with Reflector



Bowens Mount

M600Bi

- CCT: 2800K-6500K
- 17,500 lux (with reflector)/40,100lux (with Fresnel) at 9.8'
- Well-engineered to evenly blend the colors
- Top-notch control box
- CRI≥96, TLCI≥97
- Adjustable finely in 0.1% or quickly in 10% increments
- 4 dimming curves
- Supporting V-mount battery power supply
- Powerful cooling system
- Controls: DMX, App control, 2.4GHz remote, on-board
- 7 built-in FX effects
- Bowens mount for wide compatibility

Daylight/Bi-color LED Light | M600D/M600Bi



Daylight/Bi-color LED Light | M600D/M600Bi

M600D

Light Body	×1	Connecting Cord	×1
Controller	×1	Controller clamp(LAS-19&LSA-03)	×1
Lamp Cover	×1	Fixed Rope	×1
Pro Reflector	×1	Portable Case	×1
Power Cord	×1		



M600Bi

Light Body	×1	Connecting Cord	×1
Controller	×1	5m Power Cord	×1
Portable Case	×1	Connecting Cord Fixed Rope	×1
Lamp Cover	×1	Standard Reflector RFT-19	×1
Controller Clamp (LSA-19&LSA-03)	×1		



Sunset simulation



On-location night scene



Commercial lighting



CRI 96+
CRI≥96

TLCI 97+
TLCI≥97

CCT(M200Bi & M300Bi)
2800K-6500K

Supporting V-mount
Battery

Bowens Mount

M200D/M200Bi/M300D/M300Bi

- Providing the highest value of a 200W or 300W LED light
- CCT (M200Bi & M300Bi): 2800K-6500K
- All-in-one control box
- CRI≥96, TLCI≥97
- 4 dimming curves
- Supporting V-mount battery power supply
- Powerful cooling system
- Controls: DMX, App control, 2.4GHz remote, on-board
- Built-in FX effects
- Bowens mount for wide compatibility

Daylight/Bi-color LED Light | M200D/200Bi/300D/300Bi



Outdoor lighting

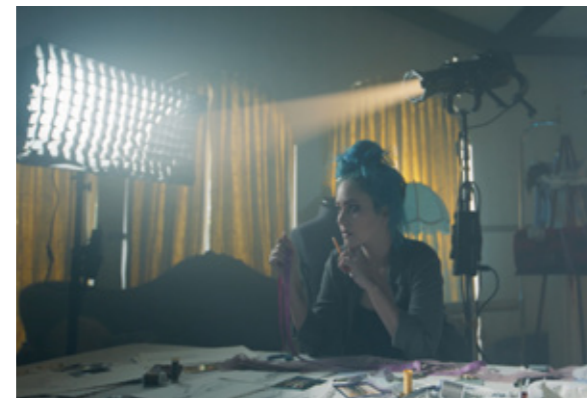

Interior lighting



Daylight simulation

Daylight/Bi-color LED Light | M200D/200Bi/300D/300Bi



M200D

Light Body	×1	Carry Bag CB49	×1
Connecting Cable	×1	Controller Clamp(LSA-19&LSA-03)	×1
5m Power Cable	×1	Bowens Mount Pro Reflector RFT-19	×1
Fixed Rope	×1	Controller	×1
Lamp Cover	×1		



M200Bi

Light Body	×1	Carry Bag CB49	×1
Connecting Cable	×1	Controller Clamp(LSA-19&LSA-03)	×1
5m Power Cable	×1	Bowens Mount Pro Reflector RFT-19	×1
Fixed Rope	×1	Controller	×1
Lamp Cover	×1		



M300D

Light Body	×1	Carry Bag CB49	×1
Connecting Cable	×1	Controller Clamp(LSA-19&LSA-03)	×1
5m Power Cable	×1	Bowens Mount Pro Reflector RFT-19	×1
Fixed Rope	×1	Controller	×1
Lamp Cover	×1		



M300Bi

Light Body	×1	Carry Bag CB49	×1
Connecting Cable	×1	Controller Clamp(LSA-19&LSA-03)	×1
5m Power Cable	×1	Bowens Mount Pro Reflector RFT-19	×1
Fixed Rope	×1	Controller	×1
Lamp Cover	×1		



IP54
Weather
Resistance



DMX512



CRMX



0.1% Adjustment



Efficient Heat
Dissipation

M600R

- 20,000 lux with reflector at 1 meter
- IP54 weather-resistance
- Extreme temperature performance even under -20°C
- Controls: DMX, LumenRadio CRMX, Ethernet (sACN and ArtNet protocol), App control, on-board
- Bowens mount
- 8-meter DC cable for flexible position
- New optical technology for reduced temperature and associated risks



FOCUSING LIGHTS



SPECS

Model	S60	S60Bi
Power Supply	AC Power Supply: 100~240V 50/60HZ 0.9A MAX V-port battery: Standard voltage: 14.8V (optional)	AC Power Supply: 100~240V 50/60HZ 0.9A MAX V-port battery: Standard voltage: 14.8V (optional)
Output Power	60W	77W
CCT	5600K±300K	2800K±6500K
100% Illuminance(LUX)(1m,darkroom)(≈)	Spot (Central Area): 3200 Flood (Central Area): 40000	Spot (Central Area): 3200 Flood (Central Area): 40000
CRI/TLCI	≥96/≥97	≥96/≥97
Brightness Range	0~100%	0~100%
Channel(CH)	32 (1 to 32)	32 (1 to 32)
Group (GR)	16 (A to F/O to 9)	16 (A to F/O to 9)
Beam Angle	6°-55°	6°-55°
Working Environment Temperature	-10~40°C	-10~40°C
Control Method	Smartphone APP/2.4G wireless remote control/DMX control	Smartphone APP/2.4G wireless remote control/DMX control
2.4G Wireless Transmission Distance(≈)	50m	50m
Dimension	Light Body: 264*107*100mm/Controller: 268*113*64mm	Light Body: 264*107*100mm/Controller: 233*112*61mm
Weight	Light Body: 1.36kg/Controller: 0.94kg	Light Body: 1.36kg/Controller: 1kg



Beam Angle 6°-55°



2800-6500K(Bi)

CRI 96+

CRI≥96

TLCI 97+

TLCI≥97



Silent mode

S60/S60Bi

- Beam angle from 6 to 55 degrees, light where you want
- Variable Color Temperature
- CRI≥96, TLCI≥97
- Lighting FX
- Silent mode
- Controls: Godox Light app, remoter, and DMX

Focusing Lights | S60/S60Bi



S60/S60Bi

Light Head	x1	Wrench	x1
Controller Box	x1	Connect Cable	x1
SA-08 Barndoor Set	x1	Power Cable	x1

Focusing Lights | S60/S60Bi

Projection attachment: project a highly focused and controlled beam of light. This attachment is what enables you to get the utmost out of creativity of Focusing light series for it is specially designed for fitting a vast range of light shaping accessories.



Abundant Accessories

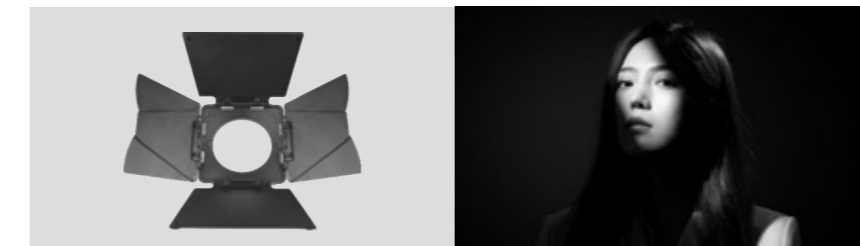

SA-08 Barndoor Set

Barndoor set: to precisely control the light beam as required. There are small clips on the plate for clipping diffusion fabric or gels on.

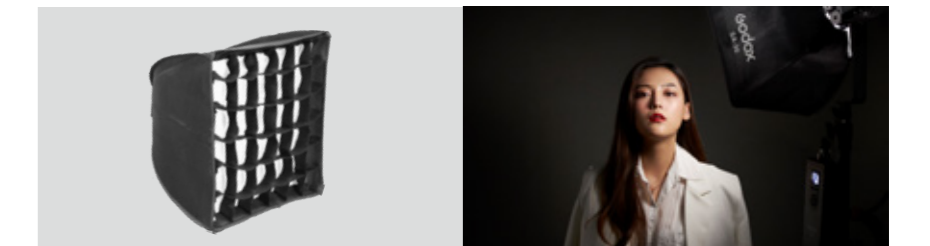

SA-30/SA-20 Softbox

Offers soft and even light effects.

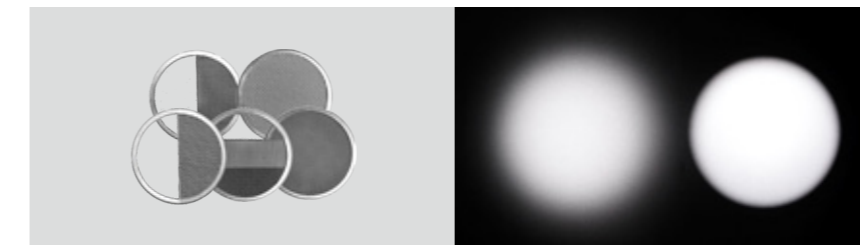

SA-05 Scrim set

To reduce the light intensity and control the light graduation.



SA-07 Scrim set

To reduce the light intensity and control the light graduation.



Simulating natural backgrounds



Adding atmosphere for scene



Product shooting



PANEL LIGHTS



SPECS

Model	P600Bi Hard	P300R	P600R
Luminance	11,400Lux @3m (5600K)	1,620Lux @3m (5600K)	3,230Lux @3m (5600K)
Color Version	Bi-color	RGBWW	RGBWW
CCT	2800K-6500K	1800-10000K	1800-10000K
Max. Power	650W	≈350W	≈350W
Color Rendering	CQS≥93/CRI≥96/TLCI≥96	CQS=95/CRI≥96/TLCI≥96	CQS≥95/CRI≥96/TLCI≥96
Controls	CRMX/DMX/App/On-board/Remoter	CRMX/DMX/App/On-board/Remoter	CRMX/DMX/App/On-board/Remoter
Power Supply	AC	AC/DC 48V	AC/DC 48V
Dimension	571*499*121mm(Yoke included)	563*498*155mm	776*567*153mm
Weight	10kg	11.6kg	17.8kg

LED Light Panel | P600Bi Hard



LED Light Panel | P600Bi Hard



POWER
650_w
Power 650W

2800K-6500K

93,800Lux at 1 meter

LumenRadio CRMX

10_{KG}
Lightweight 10KG

P600Bi Hard

- CCT: 2800K-6500K
- 650W full output across all color temperatures
- A 10kg 1x1 panel
- 93,800Lux at 1 meter
- Precisely designed optical lens
- CQS≥93, CRI≥96, TLCI≥96
- 0.1% stepless adjustment from 0.1% to full power
- Controls: DMX & CRMX, App control, 2.4GHz remote, on-board
- Aerospace-grade heat dissipation



Combined use as key light



Interior lighting



Green screen lighting solution



P600Bi Hard

Light Body	×1	U-type Bracket	×1
Tying Rope	×1	Antenna	×1
Safety Rope	×1	AC Power Cable	×1
Hex Wrench	×1		

Optional Purchase



Space Light Softbox P600BHSS



Rectangular Softbox (24"x24") P600BHS22

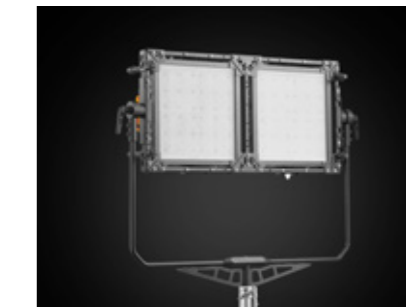

2-light Bracket AB02



4-light Bracket AB04



Junior Offset Arm HJ02



Junior Multi-header HJ04



Softbox (2'x3') for AB02 AB02S23

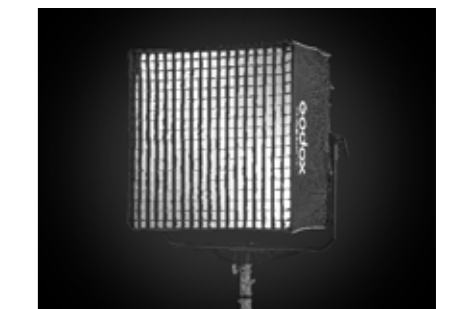

Softbox (3'x3') for AB02 AB04S33



RGBWW



CMRX



Super Bright



Even Beam



Wide Emitting Angle

P600R Hard/P1200R Hard

- CCT: 1800K-10000K
- RGBWW capable
- Compact size and lightweight
- High efficient heat dissipation
- Precisely designed optical lens
- CQS≥95, CRI≥96, TLCI≥96
- 0.1% stepless adjustment from 0.1% to full power
- 4 dimming curves
- 14 built-in FX effects
- Controls: DMX, CRMX, removable remote control, App control, 2.4G wireless control, and on-board control
- Abundant accessories for light-shaping



RGBWW



DMX512



CRMX



0.1% Adjustment



Efficient Heat
Dissipation

P300R/P600R

- CCT: 1800K-10000K
- RGBWW capable
- Ideal for virtual production applications
- Compact size with higher pixel density in 1x1 ft (4 pixels) and 1x2 ft (8 pixels) options
- Accurate color for realistic imaging
- High brightness with soft light quality
- Flicker-free light
- Ultra-precise dimming starting from 0.1% brightness
- CQS≥95, CRI≥96, TLCI≥96
- Integrated design with built-in PSU for easy transport
- High-efficiency cooling fan for sustained performance
- Controls: DMX, CRMX, Ethernet(support ArtNet and sACN), removable remote control, App control, 2.4G wireless control, and on-board control
- Includes diverse accessories like softboxes and brackets

LED Light Panel | P300R/P600R



P300R

Light Body	x1	Safety Wire	x1
Antenna	x1	Main Cable	x1
Typing Rope	x1		

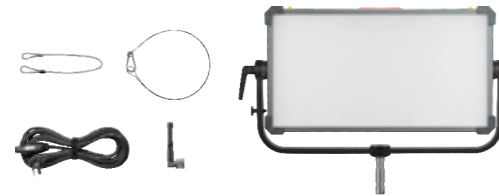

P600R

Light Body	x1	Safety Wire	x1
Antenna	x1	Main Cable	x1
Typing Rope	x1		

Optional Purchase for P300R

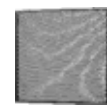

P300RH30
Honeycomb 30°



P300RB4
Barndoor



P300RS33+P300RS33G
Softbox 3'x3'+Grid



P300R04+P300R04G
Softbox Octa 4'+Grid



AB02
2-Light Bracket



AB04
4-Light Bracket

LED Light Panel | P300R/P600R



P300R K1 Kit

Light Body	x1	Main Cable	x1
Antenna	x1	Quick Setup Softbox	x1
Typing Rope	x1	Soft Case SC02	x1
Safety Wire	x1		



P600R K1 Kit

Light Body	x1	Main Cable	x1
Antenna	x1	Quick Setup Softbox	x1
Typing Rope	x1	Soft Case SC04	x1
Safety Wire	x1		



AB02S23
Softbox (2'x3') for AB02

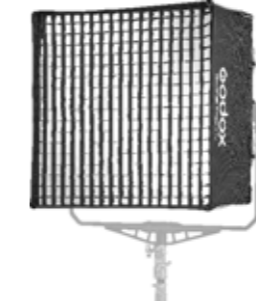

AB04S33
Softbox (3'x3') for AB04



P300RY02
P.O.Yoke



P300RY03
Double Vertical Yoke



P600BHSS
Space Light Softbox



P600BHS22
Rectangular Softbox
(24''x24'')



SC02
Soft Case

Optional Purchase for P600R



P600RH30
Honeycomb 30°

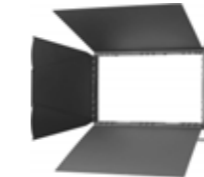

P600RB4
Barndoor



P600RS23+P600RS23G
Softbox 2'x3'+Grid



P600RS34+P600RS34G
Softbox 3'x4'+Grid



P600R05+P600R05G
Softbox Octa 5'+Grid



P600RY02
P.O.Yoke



P600RY03
Double Vertical Yoke



SC04
Soft Case



FLEXIBLE LED MAT



SPECS

Model	F200Bi	F400Bi	F600Bi
Luminance	1,130Lux @3m (5600K)	2,280Lux @3m (5600K)	3,240Lux @3m (5600K)
Color Version	Bi-color	Bi-color	Bi-color
CCT	2700K-8500K	2700K-8500K	2700K-8500K
Max. Power	210W	410W	670W
Color Rendering	CRI>96/TLCI>96	CRI>96/TLCI>96	CRI>96/TLCI>96
Controls	DMX/App/On-board/Remoter	DMX/App/On-board/Remoter	DMX/App/On-board/Remoter
Power Supply	AC/DC 48V/V-mount battery	AC/DC 48V/V-mount battery	AC/DC 48V/V-mount battery
Dimension	650*631*29mm	1209*627*23mm	1210*1210*24mm
Weight	1.83kg	3.1kg	3.8kg

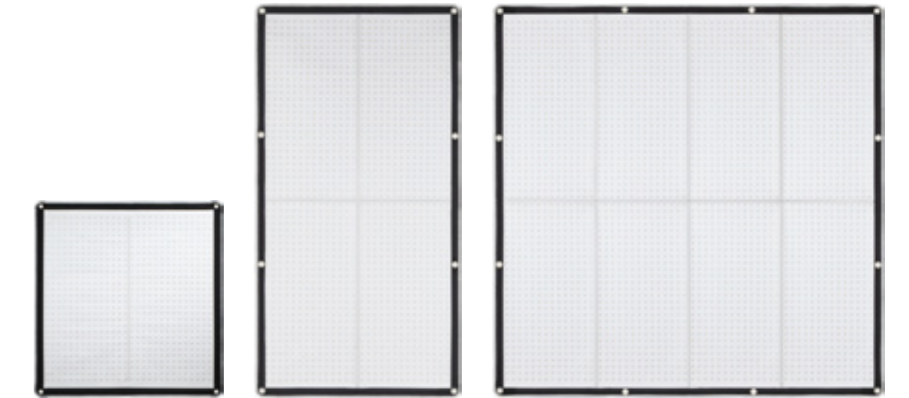

Foldable



Lightweight

IP65

Water-resistance



2700K-8500K

F200Bi/F400Bi/F600Bi

- CCT: 2700K-8500K
- Slim and flexible design suitable for use in narrow or curved spaces
- LED mats in 200W, 400W, 600W options
- Consistent full power output across all color temperatures
- CRI 96+, TLCI 96+
- Linear/S-Curve/Logarithmic/Exponential dimming curve
- Light body with a foldable design and IP65 water resistance
- High-quality aluminum alloy frame construction
- Easy to fold and transport
- Controls: DMX, App control, 2.4GHz remote, on-board
- CRMX support with optional TimoLink receiver (Sold Separately)
- Power options: AC, DC 48V, and V-mount batteries

Flexible LED Mat | F200Bi/F400Bi/F600Bi



Flexible LED Mat | F200Bi/F400Bi/F600Bi



F200Bi

Light Body	×1	5m Power Cable	×1
Control Box	×1	Adapter Holder	×1
X Bracket	×1	Softbox with Grid FS200	×1
3m Connect Cable	×1	Carry Bag CB87	×1



F400Bi

Light Body	×1	5m Power Cable	×1
Control Box	×1	Adapter Holder	×1
X Bracket	×1	Softbox with Grid FS400	×1
3m Connect Cable	×1	Carry Bag CB87	×1



F600Bi

Light Body	×1	Softbox with Grid FS600	×1
Control Box	×1	Carry Bag CB88	×1
3m Connect Cable	×1	Detachable metal frame MB-F600	×1
5m Power Cable	×1		

Optional Purchase



Pancake Lantern
FP200 for F200Bi
FP400 for F400Bi
FP600 for F600Bi

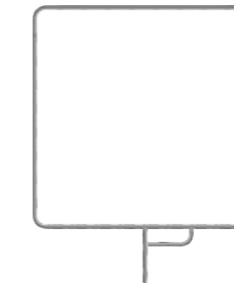

Flag Frame
FF200 for F200Bi



Remote Control
RC-R9II or RC-A6II



5m DC Cable
F-DC5A for F200Bi
F-DC5B for F400Bi
F-DC5C for F600Bi



Nano Clamp
L SA-03&LSA-19



Wireless DMX Transmitters
and Receivers
TimoL ink TX/TimoL ink RX



Hanging use for close-up shot



Indoor on-location lighting



Narrow-space lighting



TUBE LIGHTS

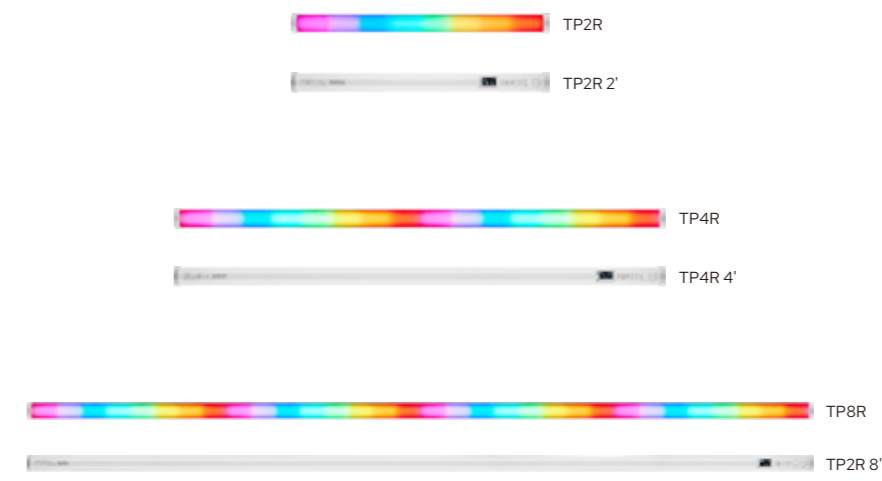

SPECS

Model	TP2R	TP4R	TP8R
Luminance	565Lux @1m (5600K)	765Lux @1m (5600K)	994Lux @1m (5600K)
Color Version	RGBWW	RGBWW	RGBWW
CCT	2000K-10000K	2000K-10000K	2000K-10000K
Pixels	16	32	64
Max. Power	26W	47W	83W
Color Rendering	CRI≥96/TLCl≥97	CRI≥96/TLCl≥97	CRI≥96/TLCl≥97
Controls	CRMX/DMX/App/On-board/Remoter	CRMX/DMX/App/On-board/Remoter	CRMX/DMX/App/On-board/Remoter
Built-in Battery	Included	Included	Included
Power Supply	AC/built-in battery	AC/built-in battery	AC/built-in battery
Dimension	47*47*600mm	47*47*1200mm	47*47*2400mm
Weight	0.84kg	1.5kg	2.94kg



TP2R

TP2R 2'

TP4R

TP4R 4'

TP8R

TP2R 8'

High pixel density

For Mapping Use

Lumen Radio CRMX

180° Rotatable Screen

2000K-10000K

TP2R/TP4R/TP8R

- High pixel density: 16(TP2R)/32(TP4R)/64(TP8R)
- Sizes: 2'(TP2R)/4'(TP4R)/8'(TP8R)
- CCT: 2000-10000K
- RGBWW capable
- CRI≥96, TLCI≥96
- Controls: DMX & CRMX, App control, 2.4GHz remote, on-board
- Selectable 8-bit & 16-bit modes
- 14 built-in FX effects
- 180° rotatable on-board screen for easy reading
- Excellent diffusion panel

RGBWW Pixel Tube Light | TP2R/TP4R/TP8R



Car scene lighting



Music video lighting

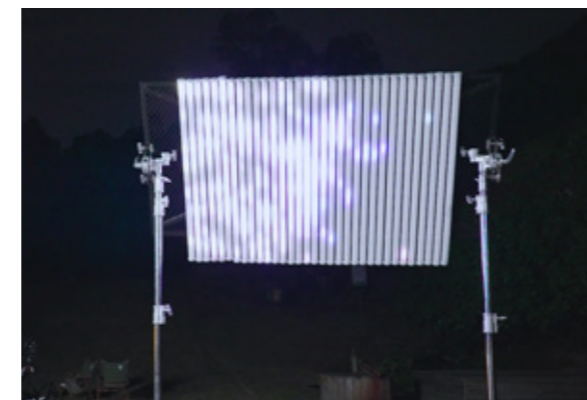

Pixel mapping

RGBWW Pixel Tube Light | TP2R/TP4R/TP8R

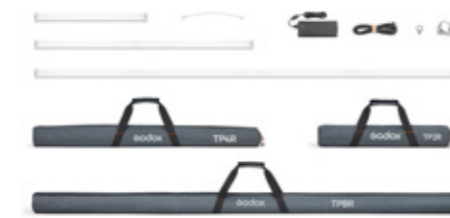

TP2R
Four-light Kit for TP2R

- 2' Pixel Tube light ×1
- One for Two Adapter ×1
- Power Cord ×1
- Clip ×1
- Bolt ×1
- Steel Rope ×1
- Carry Case CB76 ×1



TP2R-K4
Four-light Kit for TP2R

- 2' Pixel Tube light ×4
- One for Two Adapter ×2
- Power Cord ×2
- Clip ×4
- Bolt ×8
- Steel Rope ×8
- Carry Case CB76 ×1



TP4R-K4
Four-Light Kit for TP4R

- 4' Pixel Tube light ×4
- One for Two Adapter ×2
- Power Cord ×2
- Clip ×8
- Bolt ×8
- Steel Rope ×8
- Carry Case CB77 ×1



TP8R-K8
Eight-light Kit for TP4R

- 4' Pixel Tube Light ×8
- Power Box ×1
- Power Cord ×1
- Clip ×16
- Double Male Straight DC Cord ×8
- Bolt ×16
- Steel Rope ×16
- Carry Case CB79 ×1

Optional Purchase



Two-light Bracket Kit
TP-B2 (for TP2R/TP4R)



Four-light Bracket Kit
TP-B4 (for TP2R/TP4R)



Eight-light Bracket Kit
TP-B8 (for TP2R/TP4R)



Softbox TP-S2/TP-S4



Air Soft Tube
TP-S2A/TP-S4A



Power Box
TP-P600



Floor Stand TP-FS60



Multi-tube Light
Connector TP-M2



DMX Adapter
Cable DMX-C1



TimoLink TX
Wireless DMX Transmitter



One for Two Adapter
TP-A2R/TP-A4R/TP-A8R



10m Power Cable
AC10A



5m DC Cable
TP-DC5



D-TAP to DC Male
Connector Cable DT-C1



SPECS

Model	AT200Bi
Power Supply	100V-240V~50/60Hz 2.1A
Max. Power	≈210W
CCT	2700-8500K
Brightness Range	0%-100%
Dimming Curves	linear, s-curve, exponential, logarithmic
FX Modes	11
CRI	Average≥96
TLCI	Average≥96
Waterproof Grade of Light Body	IP65
Controlling Methods	DMX 512 Control (support RDM protocol), 2.4GHz Wireless Control, Bluetooth APP Control
Bluetooth Controlling Distance	Max. 30m
2.4G Remote Control Distance	Max. 60m
Type-A USB Port	Firmware Upgrade/5V~1A Power Supply
Dimension	Light Body: 280mm*267mm*1226mm/11"*11"*48" (With air bag and in the inflated state, does not include the connection cable.) Controller: 124mm*132mm*270mm
Netweight≈	Light Body: 2.15kg (Including airbag)/Controller: 2.8kg



180° Light Emission



POWER
200_w



Multiple Controls



2700K-8500K



Detachable Design

AT200Bi

- CCT: 2700K-8500K
- LED mat with an inflatable softbox for soft, even lighting
- Handheld, suspended, or stand-mounted options
- Modular design for easy maintenance
- Multiple control options including DMX512, app control, and wireless remote
- Controls: DMX, App control, and wireless remote
- Maximum power of 210W
- High CRI and TLCI ratings above 96
- IP65 weather-resistant light body
- Sweeping 180° generous beam spread
- AC power and V-mount battery support
- Foldable, lightweight design
- 11 built-in FX lighting effects

AMBIENT LIGHTS



SPECS

Model	C5R	C7R	C10R
Luminance	200Lux @1m (6500K)	101Lux @1m (5500K)	130Lux @1m (5500K)
Color Version	RGBWW	RGBWW	RGBWW
CCT	2500K-8500K	2000K-10000K	2000K-10000K
Max. Power	5W	7W	10W
Color Rendering	CRI=96/TLCI=96	CRI=96/TLCI=97	CRI=96/TLCI=97
Controls	On-board/App	On-board/App	On-board/App
Built-in Battery	Included	Included	Not included
Power Supply	5V/2A Type-C DC charging/ wireless charging/built-in battery	AC (lamp socket)/5V/ 2.5A Type-C DC charging/built-in battery	AC (lamp socket)/5V/ 3A Type-C DC charging
Dimension	106*68*18mm	73*73*136mm	73*73*136mm
Weight	169g	256g	236g

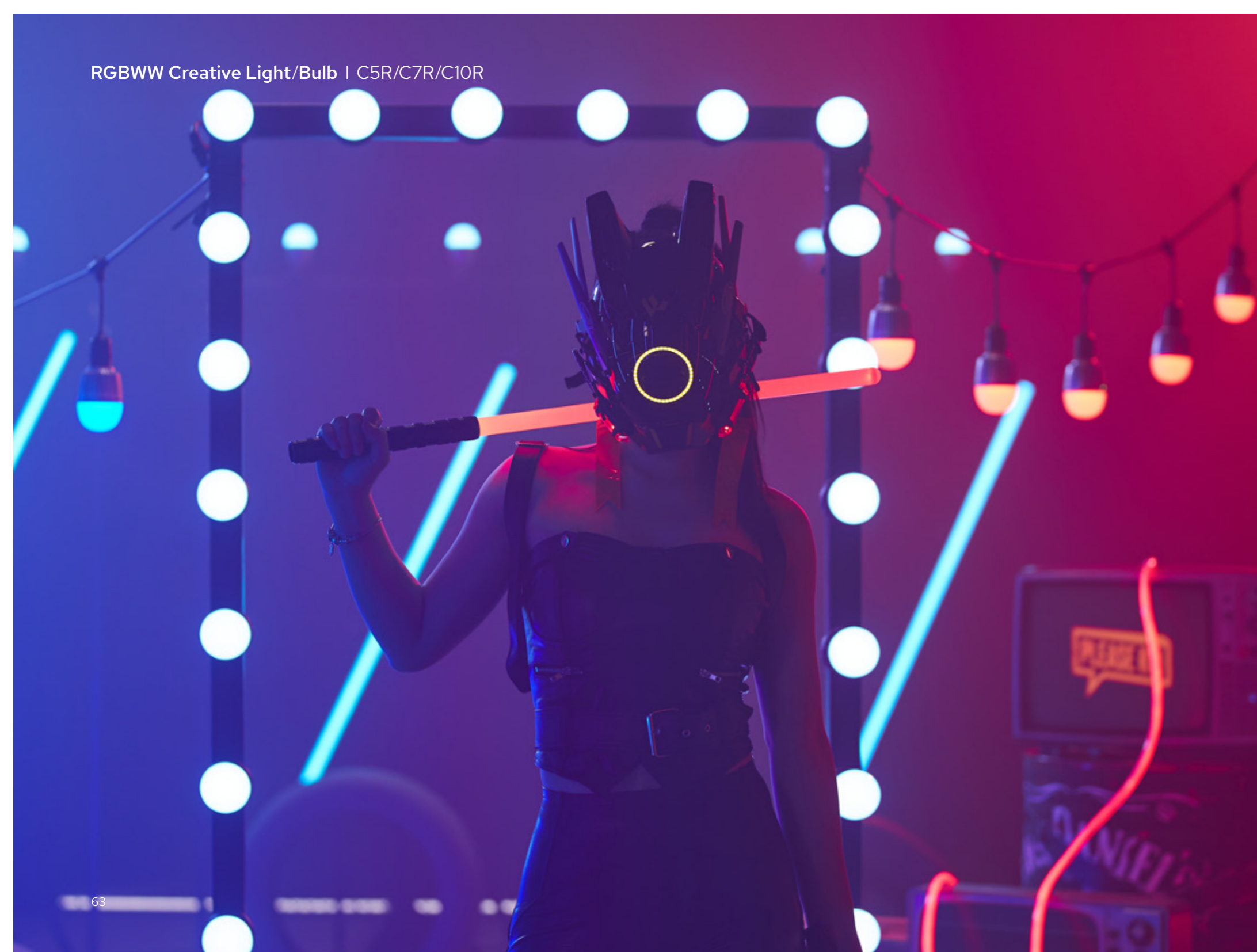

Lightweight



RGBWW



Magnetic stripe design



Built-in battery



Type-C wireless charging



Constant power



RGBWW



2000-10000K



Built-in battery (C7R)



C5R

- Lightweight and portable
- CCT: 2500-8500K
- RGBWW capable
- CRI≥96, TLCI≥97
- Two independent dials for easy adjustment
- Magnetic back for easy attachment
- 39 FX effects for creative lighting
- Built-in 3000mAh lithium battery for 2-hours runtime at full output
- Wireless/Type-C charging
- Controls: Godox Light App, on-board
- Includes a collapsible diffuser
- Available in an 8-light charging kit

C7R/C10R

- Constant power design ensures stable lighting
- CCT: 2000-10000K
- Magenta-green adjustment.
- RGBWW capable
- Built-in battery for C7R
- CRI≥96, TLCI≥97
- Quick reset of bluetooth connection via on-board buttons
- Precise control via Godox Light App
- Power supply: AC/DC
- Available in E26 and E27 base options for versatile compatibility
- C7R available in an 8-light charging kit



Practical lighting



Ambient lighting



Colorful atmosphere

C5R



Light Body x1 Collapsible Diffuser x1 Carry Bag CB50 x1 Coldshoe Base x1 USB Type-c Cable x1

C5R-C8 Eight-light Charging Case for C5R



Charging Case x1
Charging Case Power Cord x1
USB-C Cable x2
D-TAP to DC Adapter Cable x1

C5R-K8 Eight-light Charging Case Kit for C5R



C5R x8
Collapsible Diffuser x8
Charging Case Power Cord x1
Charging Case x1
USB-C Cable x2
D-TAP to DC Adapter Cable x1
Cold Shoe Mount x2

C7R/C10R



Light Body x1 Storage Bag x1 Type-C Cable x1

Optional Purchase (for C7R/C10R)

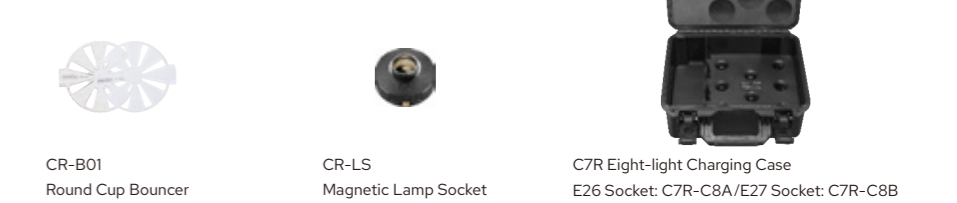

CR-B01 Round Cup Bouncer CR-LS Magnetic Lamp Socket C7R Eight-light Charging Case x1 E26 Socket: C7R-C8A/E27 Socket: C7R-C8B

Eight-light Charging Case Kit for C7R

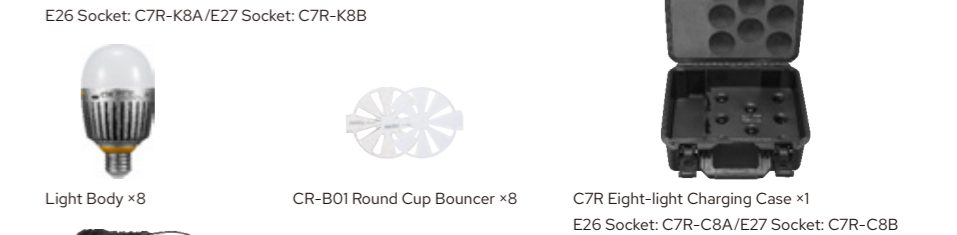

E26 Socket: C7R-K8A/E27 Socket: C7R-K8B Light Body x8 CR-B01 Round Cup Bouncer x8 C7R Eight-light Charging Case x1 E26 Socket: C7R-C8A/E27 Socket: C7R-C8B Storage Bag for Round Cup Bouncer x2 1.5m Charging Case Power Cord x1 Type-C Cable x2

Eight-light Kit for C10R

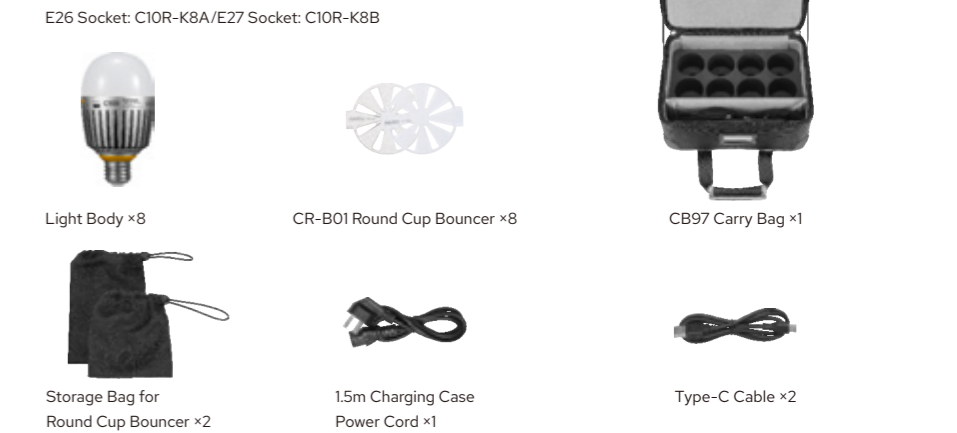

E26 Socket: C10R-K8A/E27 Socket: C10R-K8B Light Body x8 CR-B01 Round Cup Bouncer x8 CB97 Carry Bag x1 Storage Bag for Round Cup Bouncer x2 1.5m Charging Case Power Cord x1 Type-C Cable x2



CINE LIGHTING REFLECTOR



High Reflectance



Four Diffusion Types



Varied Sizes



Versatile Applications



Comprehensive Accessories

LiteFlow 7/15/25/50/100

- Exceptional reflectance with a mere 3% power loss
- A variety of diffused lighting effects: D1/D2/D3/D4
- Five size options: 7×7/15×15/25×25/50×50/100×100 cm
- Sleek rail structure with a guide slot design, ensuring seamless installation
- Leveraging the square inverse law to extend the light path
- Effortless adjustments for convenient control
- Directly utilizing natural sunlight to balance lighting contrast, even without artificial sources
- Redirecting a single light source multiple times, reducing the need for additional fixtures and light-shaping tools
- Mimicking natural light decay, guaranteeing even lighting across the illuminated area
- Varying sizes grant you precise control over the illuminated area
- Coming with a comprehensive range of accessories



LiteFlow 7



LiteFlow 7D1×1



LiteFlow 7D2×1



LiteFlow 7D3×1



LiteFlow 7D4×1



Soft Case SC13×1

LiteFlow 15



LiteFlow 15D1×1



LiteFlow 15D2×1



LiteFlow 15D3×1



LiteFlow 15D4×1



Soft Case SC14×1

LiteFlow 25



LiteFlow 25D1×1



LiteFlow 25D2×1



LiteFlow 25D3×1



LiteFlow 25D4×1



Soft Case SC15×1

LiteFlow 50



LiteFlow 50D1×1



LiteFlow 50D2×1



LiteFlow 50D3×1



LiteFlow 50D4×1



Soft Case SC16×1

LiteFlow 100



LiteFlow 100D1&D3×1 Yoke×1



LiteFlow 100D2&D4×1 Yoke×1

LiteFlow 100 K1



LiteFlow 100D1&D3×1 Yoke×1



LiteFlow 100D2&D4×1 Yoke×1



Flight Case FC04×1



Narrow space lighting

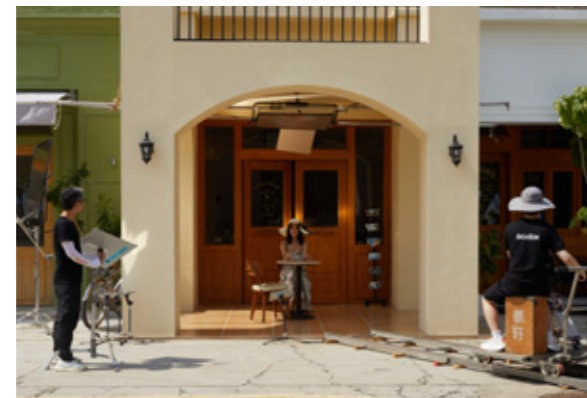

Utilizing sunlight outdoors



With high-output fixtures in low positions

LiteFlow K1

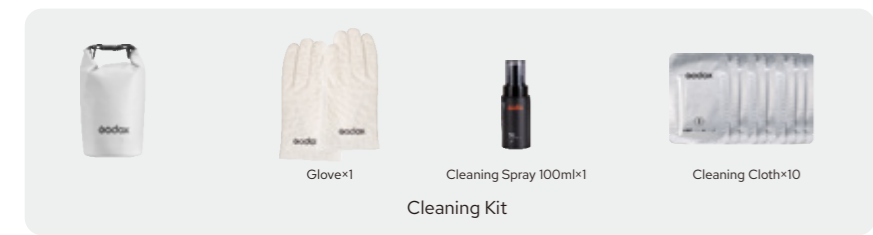
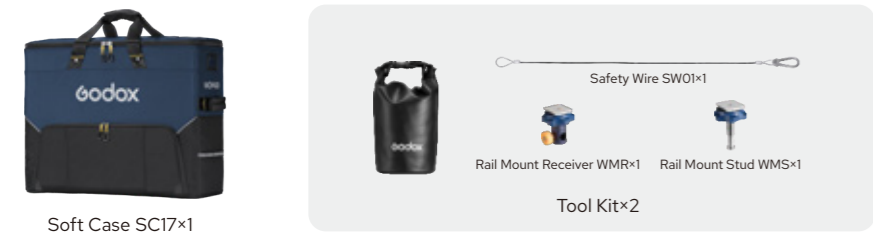

Optional Purchase



Rail Mount

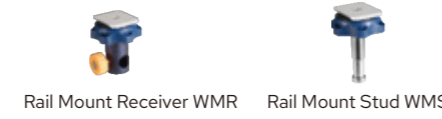

Gag

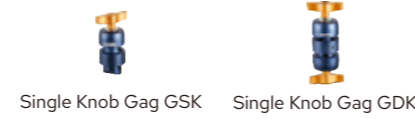

Rod Set

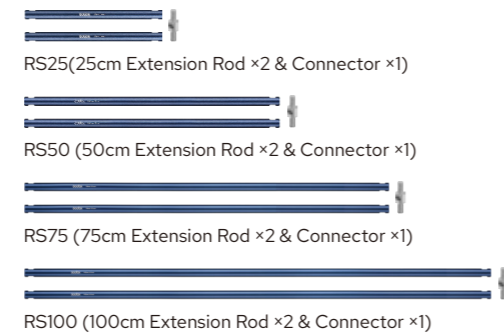

Multi-Adapter



Ball-Joint Arm



Flexible Arm (Important Note: Maximum load 1kg, restricted to use with LiteFlow7/15/25.)



Multi-Reflector Array Grip Kit GK7



Multi-Reflector Array Grip Kit GK25

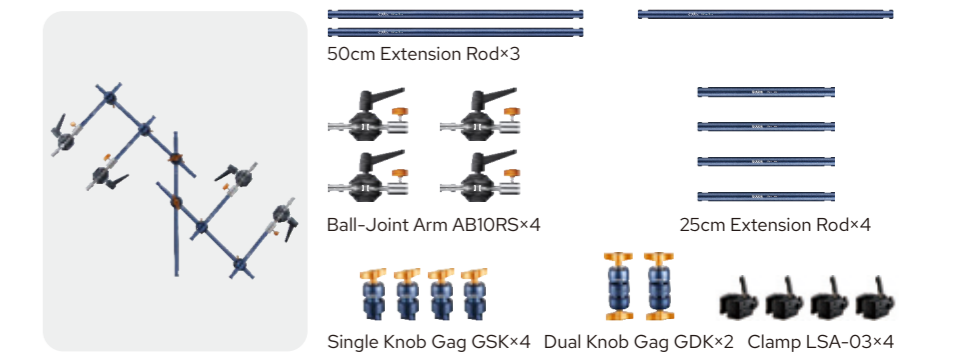

Multi-Reflector Array Grip Kit GK50

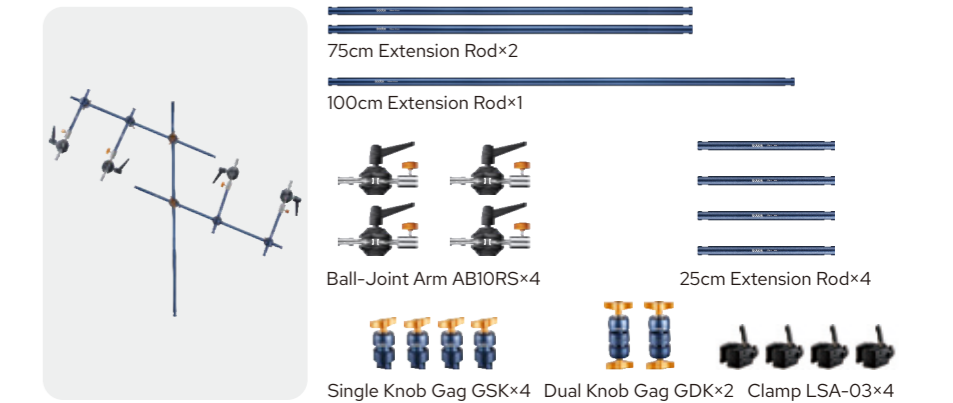

Cleaning Kit CK01



Safety Wire

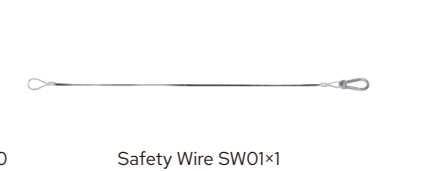



ACCESSORY

G-Mount Projection Attachment | GP19K/26K/36K



GP19K/26K/36K

- Evenly intensifying the illumination by times
- Project a crisp and clear beam without aberration
- Easily realizing versatile lighting effects with various accessories
- The rotatable handle allows more smooth and precise control
- Interchangeable lenses in 19°, 26°, 36°
- Efficient cooling system powered through G-Mount

Tech Specs

Mode	Dimension	Dimension
Projection attachment	418*647*727mm/16.5*25.5*28.6" (including lens)	≈11.6kg(excluding lens)
Lens 19°	281*235*289mm/11.1*9.3*11.4"	≈9.94kg
Lens 26°	281*235*289mm/11.1*9.3*11.4"	≈8.41kg
Lens 36°	281*234*287mm/11.1*9.2*11.3"	≈8.23kg



- GP19K/26K/36K Projector ×1
- Gobo Holder ×1
- Gobo Set ×1
- Portable Case ×1
- Lens ×1



Bowens Mount Projection Attachment | VSA-19K/26K/36K



VSA-19K/26K/36K

- Evenly intensify the illumination
- Project a crisp and clear beam without aberration
- Internal shutter blades for precise beam cutting
- With Gobos to create various backgrounds
- Three interchangeable lenses 19°, 26°, and 36°

Tech Specs

Mode	Dimension	Dimension
Projection attachment(excluding lens)	516*241*196mm/20.3*9.5*7.7"	3.42kg
Lens 19°	135*219*137mm/5.3*8.6*5.4"	1.94kg
Lens 26°	135*219*137mm/5.3*8.6*5.4"	1.94kg
Lens 36°	135*219*137mm/5.3*8.6*5.4"	1.94kg



- Spot Light Mount ×1
- 19°Lens/26°Lens/36°Lens ×1
- Gobo Holder ×1
- Gobo ×1
- Gel Frame ×1
- Portable Bag ×1

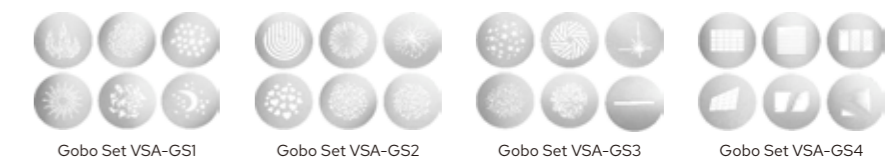



GF14/FLS8/FLS10

FLS8+LB-01

FLS8 is compatible with the majority of Godox Bowens Mount LED lights.

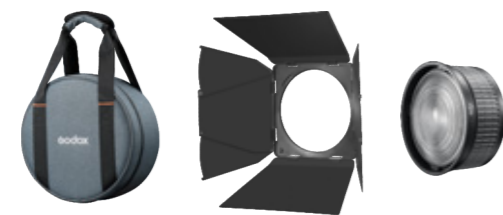

FLS10+LB-02

FLS10 is compatible with all Godox Bowens Mount LED lights.

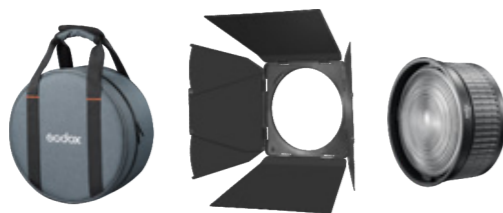

GF14+GF14B

GF14 is compatible with Godox G-Mount LED lights, such as MG1200Bi.

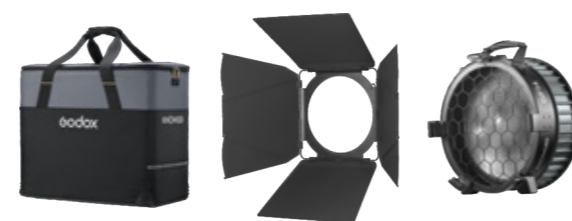

Tech Specs

Mode	FLS8	FLS10	GF14
Adjustable Beam Angle	10°-40°	10°-35°	15°-45°
Working Temperature	-10°C~40°C	-10°C~40°C	-10°C~40°C
Dimension	246*246*121mm	295*295*135mm	471*426*235mm
Weight	2kg	3kg	9.68kg

CS-50D/65D/85D

- Extremely fast setup
- Stunning, soft, omni-directional light
- Bowens Mount for compatibility
- Optional skirts for beam spread control





SF6090/SF4560 Kit

- Two versions to meet various size needs.
- Easy to store and transport with the carry case.
- Compact and foldable, making setup and usage easy.
- The black nets and one-stop silk can be used to adjust the contrast.
- The black solid fabric can be used to block unwanted illumination or create shadows.
- The two-stop silk can be used to diffuse and soften the light.
- The dots and fingers in black net and solid fabrics allow for shaping light on smaller objects or areas. Ideal for tabletop shooting or situations where larger fabrics are inconvenient.
- The open-edge design provides a softer cut of light and prevents hard transitions due to the edge.
- By finely adjusting the angle of the screen in front of the light, it allows for very changeable light and dark contrast, creating the desired transition.

Bowens Mount Quick Release Parabolic Softbox | QR-P70/P90/P120



QR-P70/P90/P120

- Reflective silver interior to render a punchy high contrast
- Removable inner and front fabric diffusers
- Impressive quick release system for rapid setup and breakdown
- Reliable light quality and various creative expressions
- Bowens mount strobes and continuous light compatible



Effortless Setup



Quick Breakdown

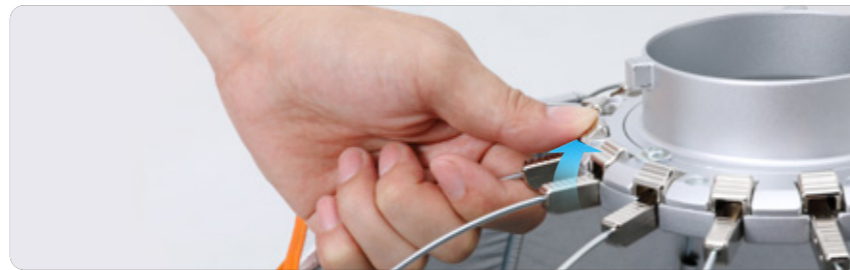

Bowens Mount | Softbox



Square Softbox



Rectangular Softbox



Strip Softbox



Octagon Softbox



Square Softbox with Grid



Rectangular Softbox with Grid



Strip Softbox with Grid



Octagon Softbox with Grid

SPECS

	Square Softbox	Rectangular Softbox	Strip Softbox	Octagon Softbox
Model	SB-BW-6060/9090	SB-BW-6090/70100/80120	SB-FW-50130/35160	SB-FW-95/120/140
Size	60x60cm(23.6"x23.6") 90x90cm(35.4"x35.4")	60x90cm(23.6"x35.4")/70x100cm(27.6"x39.4") 80x120cm(31.5"x47.2")	50x130cm(23.6"x51.2") 35x160cm(13.8"x 63.0")	φ95cm(37.4")/φ120cm(47.2") φ140cm(55.1")

Lighting Stands & Mountings

SA5015

Heavy Duty Steel Roller Stand



SA5045

Heavy Duty Steel Roller Stand

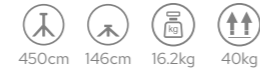

240CS

C-Stand with Arm (Silver)



270CS

C-Stand with Arm (Silver)

