

合格证
QC PASS

Godox

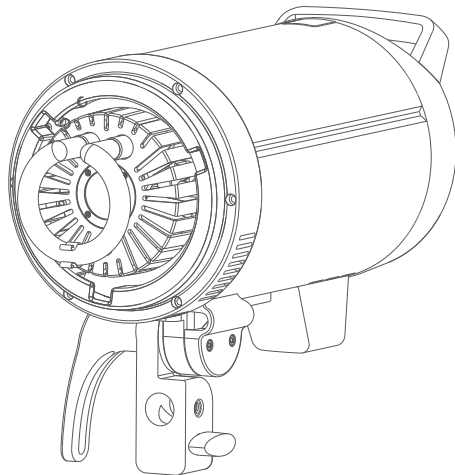

Wechat
Official Account
神牛微信公众号

深圳市神牛摄影器材有限公司

地址: 深圳市宝安区福海街道塘尾社区耀川工业区厂房2栋 电话: 0755-29609320(8062)

传真: 0755-25723423 邮箱: godox@godox.com

GODOX Photo Equipment Co., Ltd.

Add.: Building 2, Yaochuan Industrial Zone, Tangwei Community, Fuhai Street, Bao'an District,

Shenzhen 518103, China Tel: +86-755-29609320(8062) Fax: +86-755-25723423

E-mail: godox@godox.com

godox.com

Made in China | 705-DP13V0-00



DP400III ✓ DP600III ✓
DP800III ✓ DP1000III ✓

专业影室闪光灯
Professional Studio Flash

使用手册
Instruction Manual

前言

感谢您使用DPIIIV系列影室闪光灯！

DPIIIV系列影室闪光灯为摄影创作提供功能丰富、性能稳定的光效解决方案。磨砂质感，坚固耐用。机身配备无线功率插座，选配无线功率遥控器组成无线功率调节和触发系统。保荣卡口兼容各种影室附件，光效创意无与伦比；为婚纱摄影、广告拍摄、人像以及时尚摄影等提供理想光源。

主要特点：

- 内置神牛2.4G无线X系统
- 1/2000~1/8000秒闪光持续时间，回电快速
- 选配X2、XPro系列、XT16或者FT-16功率遥控器(闪光灯需要接收器)，可远程控制闪光灯功率大小、造型灯开关、蜂鸣器功能及引闪
- 61级闪光强度任意调节，LCD屏1/64-1/1精准定位输出功率
- 30W造型灯亮度可调
- 兼容性强，保荣卡口兼容各类影室附件，实现多种光效创意
- 人机工程学面板，3秒后调节参数智能记忆，开机自动恢复

! 注意事项

- 闪光灯在全功率的情况下连续引闪50次后，需冷却后再使用。如果连续使用而不冷却就会产生高温积热。
- 不可长时间连续使用造型灯，否则可能造成安装在灯头上的柔光箱等易燃附件燃烧。有易燃附件时建议不要连续使用造型灯超过10分钟。如使用超过10分钟，请冷却后再继续使用。
- 使用束光筒时，请勿长时间点亮造型灯或过频闪光(全功率每分钟不多于6次)。积热会导致闪光灯外壳受损或造成灯的损坏。
- 避免突然的碰撞，防止闪光灯管或造型灯受损。
- 本灯具仅供专业使用。
- 灯具如有损坏或热变形请尽快更换。
- 倘防护罩有明显损坏而影响其防护效果，如出现裂纹或深度刮痕，请尽快更换。

1

! 警告

在使用本设备前请仔细阅读以下警告内容，并妥善保管以便所有本产品使用者可随时参阅。

- 请勿私自拆卸产品，如产品出现故障须由本公司或授权的维修人员进行检查维修。
- 请保持干燥：请勿用湿手接触产品，亦不可将产品浸入水中或暴露于雨中。
- 请勿让儿童接触本产品。
- 闪光灯适用于通风的环境，使用时请保持灯光源部分及散热孔不被堵塞，请勿在易燃易爆的环境中使用。
- 闪光灯采用电源插头做为断接装置，应保持随时便于操作。
- 使用时严禁用手接触灯光发热部件。
- 安装及连接附件时，请关闭开关断开电源，装即闪光灯管/造型灯时，请确认灯管为冷却状态，避免烫伤，还需佩戴绝缘手套。
- 请勿将闪光灯头正对人眼闪光(特别是婴儿的眼睛)，否则可能会在短时间造成视力障碍。
- 在不使用时，请断开电源。

! 使用本产品前请先取下灯头保护罩

部件 机身

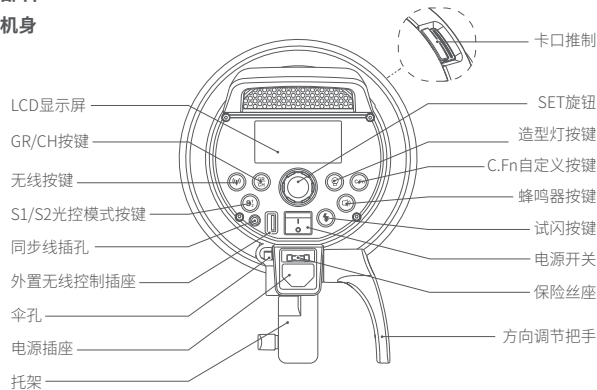

2

LCD显示屏

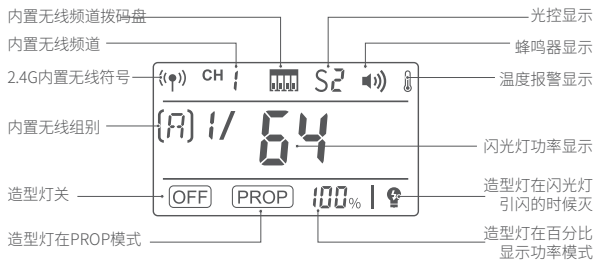

附件

1. 电源线
2. 灯头保护罩
3. 说明书

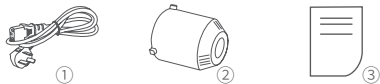

可选购附件

可搭配本公司以下摄影附件使用,以获得最佳的拍摄效果和使用体验:①X1、②X2、③XPro系列遥控器、④柔光箱、⑤反光伞、⑥灯架、⑦蜂巢、⑧雷达罩、⑨束光筒等。



使用

将闪光灯设备安装在一个合适的灯架上,调整好托架并扭紧固定,根据需要使用方向调节把手来调节灯的方向。伞孔可以插上各类影楼伞。

● 接通电源

通过电源线把闪光灯接通到交流电源上,拨动闪光灯上的电源开关,此时LCD显示屏亮起,表示连接正常。

● 造型灯使用

短按造型灯按键依次循环切换OFF、PROP、百分比。

1.当屏显示<OFF>时,表示当前造型灯处于关闭状态。

2.当屏显示<PROP>时,表示当前造型灯处于自动状态,会随着闪光灯变化而变化,会随着功率增加而变亮。

3.当屏显示百分比时,表示当前造型灯处于可调节亮度状态,调节范围为5%-100%,短按SET按钮进入调节界面,旋转SET按钮调节所需的造型灯亮度值,最后短按SET按钮退出造型灯亮度设置。

造型灯开启时,长按2秒造型灯按键,屏显示< ? >,开启造型灯在引闪时自动灭的功能,再次长按造型灯按键关闭造型灯在引闪时自动灭的功能。

安全设置:造型灯点亮4小时后会自动关闭,以防无人状态下长时间点亮导致高温积热。



如有易燃附件在灯头上,不可长时间点亮造型灯,最好是点亮10分钟后请冷却1分钟后再继续使用,注意易燃附件温度。

● 功率调节

闪光功率通过旋转SET旋钮来控制,可以从“1/64”至“1/1”自由调节,LCD显示屏将对所选择功率作准确显示,满足客户在不同环境下对光源的要求。LCD显示屏显示“OFF”时,表示闪光引闪功能关闭。从高档调节至低档,需要按下试闪按钮来放电以获得所需的功率。

● 试闪按钮

欲使闪光灯测试闪光而不拍照,请按试闪按钮。摄影师可以通过试闪按钮结合SET旋钮来调节闪光亮度。

小提示:长按SET旋钮的同时开机,可查看闪光灯的版本号。

● 同步触发

同步线插孔规格为Φ3.5mm,此处可插入同步线或者触发器触发插头对闪光灯进行同步引闪。



● GR/CH按键

短按GR/CH按键可以调节内置无线组别,LCD组别显示在闪烁时,旋转SET按钮可以更改组别;长按可以选择内置无线频道,LCD频道显示在闪烁时,旋转SET按钮可以更改频道。

● 光控使用

光控模式有3种选择,按<S1/S2>光控模式按键进行切换。

● 非光控模式:LCD没有显示S1或S2,表示光控功能已关闭。

● S1光控单元设置:按<S1/S2>光控模式按键选择S1功能,闪光灯可作为副灯使用,创造多种照明效果,适用于手动闪光环境。它会与主闪光灯的第一次闪光同步触发闪光,效果与使用无线引闪器一致。

- **S2光控单元设置:**按<S1/S2>光控模式按键选择S2功能,闪光灯可作为副灯使用,适用于TTL闪光环境。具有防预闪功能,使用带一次预闪功能的相机能用光控实现同步拍摄。它会与主闪光灯的第二次闪光同步触发闪光,即2次光控引闪。

● 声音提示

蜂鸣器按键控制蜂鸣提示的打开和关闭。短按蜂鸣器按键,当LCD显示声音符号时,表示蜂鸣提示音打开;短按蜂鸣器按键,每次回电充满时会响“BI—”一声,提示可以引闪。

● 无线按键

按<(w)>键可以开/关内置无线,LCD没有显示无线符号和频道表示内置无线关闭,显示则表示内置无线开启。开机状态下,同时按住<C.Fn>按键和蜂鸣器按键,可恢复出厂设置。

● C.Fn 菜单

F1	无线ID设置	可选OF, 01-99, 任意数字, OF表示无线ID关闭, 01-99表示无线ID打开。
F2	闪光灯功率显示	可显示为分数1/P和小数P.P两种模式。

● 报警显示

E0	没有连接温度传感器
E3	放电电容电压>额定值+10%
报警声音	BIBI 0.5s响一次,单击SET键可停止报警鸣叫。

● 记忆存储功能

闪光灯设有参数记忆功能,调节参数3秒后未变更的,闪光灯会自动存储设置好的参数。下次开机使用时初始设置跟关机前一致。

● 无线控制功能

闪光灯内置2.4G无线传输,可以配合X1、X2、Xpro系列、XT16功率遥控器使用。按<(w)>按钮开启内置无线,令屏幕显示<(w)>,此时表示进入内置2.4G无线状态。如果在拍摄现场不止一个无线闪光系统,您可以通过更改通讯频道来防止信号干扰。保证主控单元和从属单元设置为相同的频道编号即可。

设置通讯频道

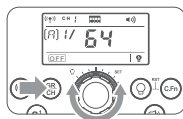

- 1 长按<GR/CH>按键2秒,频道编号闪烁显示。

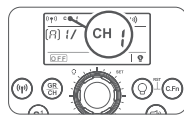

- 2 旋转SET旋钮从1至32中选择频道。

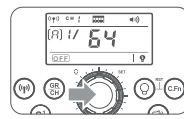

- 3 按下SET旋钮,确定。

设置通讯组别

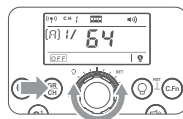

- 1 短按<GR/CH>按键,组别编号闪烁显示。

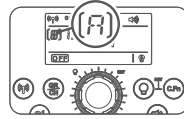

- 2 旋转SET旋钮从0至F中选择组别。

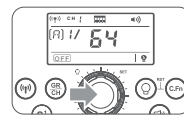

- 3 按下SET旋钮,确定。

闪光灯内置无线控制插座,配合特定遥控器使用,您可以实现对闪光灯的无线控制。将FT系列遥控器的接收端插入无线控制插座,手持遥控器发射端,即可远程控制闪光灯的功率开关和大小、闪光灯触发等。您也可以将发射端置于相机热靴上,通过相机快门来进行同步引闪。

 更多遥控器的使用方法,请查阅FT系列遥控器的说明书。

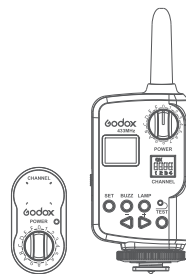

⚠️ 神牛2.4G无线漏闪的原因及解决办法:

- 1、外部环境2.4G信号干扰(如无线基站、2.4G wifi路由、蓝牙设备等)**
→请调节引闪器的频道CH设置(建议+10), 找到无干扰的频道来工作, 或者在工作时关闭其他2.4G设备。
- 2、请确认闪光灯是否已经回电或者回电速度是否已经跟上连拍速度(闪光灯就绪指示灯已经亮起), 并且没有处于过热保护或者其他异常状态中**
→请下调闪光灯功率的档位, 如是TTL模式请尝试改为M模式(TTL模式下需要预闪一次)。
- 3、是否引闪器和闪光灯距离太近(距离<0.5m)**
→请在引闪器上打开“近距离无线模式”:
X1、X2系列: 按住引闪按钮不放, 然后开机, 直至指示灯闪2次。
Xpro系列: 设置C.Fn-DIST为0-30m。
- 4、是否引闪器和接收端设备在低电状态**
→请更换电池(引闪器电池建议使用1.5V一次性碱性电池)。

● 装卸闪光灯管

关闭所有电源并拔下电源线, 带上绝缘手套, 将闪光灯管上的铁丝拧松, 用平衡力拿住灯管两脚间, 轻轻往外拉出卸下旧灯管。将旧灯管两脚上的套管取下套到新灯管两脚, 拿住新灯管两脚间, 对准灯头上两铜柱, 用力往里推进。最后将铁丝绕灯管弹片并拧紧固定好灯管。



规格参数

型号	DP400IIIIV	DP600IIIIV	DP800IIIIV	DP1000IIIIV
闪光能量	400Ws	600Ws	800Ws	1000Ws
闪光指数(ISO 100) 以米单位, 使用高效反光罩	87	106	126	140
色温	5800±200K			
电源电压	100-240V~50/60Hz			
闪光功率调控	OFF, 4.0~10.0 (1/64-1/1)			
造型灯功率	30W			
闪光触发控制方式	同步线插孔, 光控感应, 试闪按钮, 无线控制插座			
闪光持续时间	1/2000~1/800s			
同步端口输出参数	5V			
USB端口输出参数	5V/200mA (仅限神牛接收器)			
保险丝	8A			
回电时间	0.1-1s			
尺寸	灯体直径12.5Φcm, 含托架高21.5cm, 含保护罩长38cm 含保护罩长41cm			
净重 (不包含保护罩)	约2.8kg	约2.8kg	约2.8kg	约3.4kg

维护保养

- 闪光灯在工作时, 如发现异常, 应立即关掉电源, 查明原因。
- 灯体应避免震动, 平时注意表面除尘。
- 灯体稍有发热为正常现象, 无特别需要时, 勿连续引闪。
- 除灯管与造型灯消耗品用户可用原厂配置的自行装卸更换外, 所有闪光灯概由本厂指定可供原厂配件之维修部负责。
- 1年保修, 由于灯管与造型灯为消耗品, 不在1年保修范围。
- 经发现擅自检修此闪光灯, 将取消闪光灯之一年保修期, 维修需要收取相关费用。
- 如果本品出现故障或者被水淋湿, 唯有在专业人员维修后方可继续使用。
- 在维修和清洁本品时请断开电源。
- 如有技术更改, 恕不另行通知。

FOREWORD

Thanks for choosing DP11IV series studio flash.

DP11IV series studio flash provides a functional and durable lighting solution for studio and workshop shooting. It is equipped with a wireless control port so that an optional remote power control and flash triggering system is available. With a solid build, it adopts Bowens-style mount to add various studio light shaping accessories. The flash performs excellently in portrait and product shooting, wedding photography, advertising and fashion commercial photography. The DP11 flash offers:

MAIN FEATURES

- Built-in Godox 2.4G wireless X system
- 1/2000 to 1/800 second short flash duration and fast recycling with 30W modeling lamp
- Wireless control of the flash power ratio (needed a receiver), modeling lamp and buzzer, as well as flash triggering
- Anti-preflash function, enabling synchronization with cameras having a one-pre-flash firing system
- Precise output control, 61 steps from 1/64-1/1
- 30W modeling lamp with adjustable light brightness
- Compatible Bowens mount adds various accessories to give multiple lighting effects
- Adjusted settings are remembered after 3 seconds and recovered after a restart

CAUTION

- After 50 continuous flashes at full power, the flash should be cooled down before usage. Overheating will occur if it is used continuously without cooling down.
- Do not keep using the modeling lamp for a long time; otherwise flammable accessories attaching to flash head, e.g. softbox will get burnt. A 10-minute time is recommended in this case. After 10 minutes, cool it down before usage.
- When using a snoot, do not keep the modeling lamp on for a long time or fire too frequently (not over six times for one minute). Overheating will result in damages for strobe housing and/or studio light.
- Avoid sudden impacts as this can damage the flash tube and/or modeling lamp.
- The luminaire is intended for professional use only.
- The lamp shall be changed if it has become damaged or thermally deformed.
- Shields shall be changed if they have become visibly damaged to such an extent that their effectiveness is impaired, for example by cracks or deep scratches.

WARNING

To prevent damage to the product or injury to you or to others, read the following warnings in their entirety before using this product. Keep these Warning where users can read them for ready reference.

- Do not disassemble or modify. Should the product break down, send the defective back to the authorized service center for inspection and maintenance.
- Keep dry. Do not handle with wet hands, immerse in water, or expose to rain.
- Keep out of reach of children.
- Please put the device in a ventilation environment and keep the parts of lighting and heat dissipation holes are unobstructed. Do not use in flammable environment.
- As this product adopts make and break device, please keep it easy to be used.
- No touching the heating parts of this product.
- Please turn off the power and wear insulated gloves before installing and connecting accessories. When replacing the tube or modeling lamp, please make sure that the tube is cool and wear insulated gloves to prevent burns.
- Do not flash directly towards naked eyes (especially those of babies), otherwise it may lead to visual impairment.
- Disconnect from the power supply when it will not be used for an extended period.

⚠ Please remove the flash head protection cover before using.

NAMES OF PARTS

Body

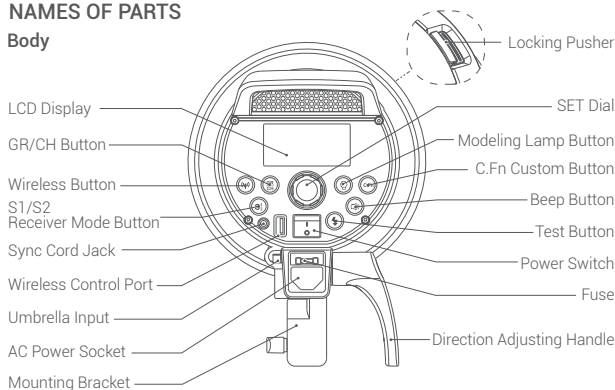

LCD Panel

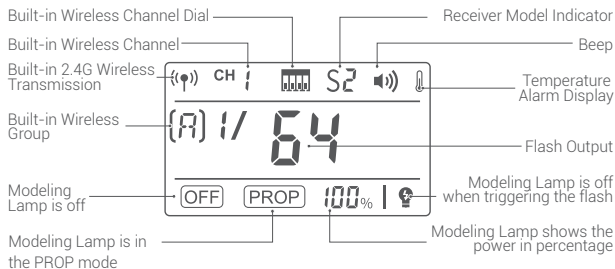

Accessories

1. Power Cord
2. Lamp Cover
3. Instruction Manual

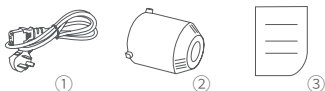

Separately sold accessories

The product can be used in combination with the following accessories sold separately, so as to achieve best photography effects: ①X1, ②X2, ③Xpro remote control, ④ Softbox, ⑤Photographic Umbrella, ⑥Light Stand, ⑦Honey comb, ⑧Beauty Dish ⑨ Snoot, etc.



OPERATIONS

Flash Preparation

Attach the flash unit onto an appropriate light stand. Adjust the mounting bracket for a good angle and make sure it is tightened and fixed. Use the direction adjusting handle to adjust the flash to a desired direction. Umbrella input is for different photo umbrellas to put in.

Power Connection

Use the power cord to connect the flash to an AC power source and turn on the power switch.

Modeling Lamp

Short press the Modeling Lamp Button to change among OFF, PROP and percentage mode.

1. When <OFF> is displayed, the modeling light is off.
2. When <PROP> is displayed, the modeling light is in auto status and its power changes with the flash's power.
3. When percentage is displayed, the brightness of modeling light can be adjusted from 5% to 100%. Short press the SET Dial and then turn it to adjust the brightness, short press to exit.

When the modeling light is on, long press the Modeling Lamp Button for 2 seconds to switch on the function that the modeling is off when triggering the flash, and the LCD panel shows (). Long press the Modeling Lamp Button again to turn off the function.

Safety Setting: Modeling lamp will be off automatically after lighting for 4 hours, avoiding overheat due to long-time lighting when the user is not nearby.



When there is flammable accessory on the flash unit, do not keep the modeling lamp on for a long time. It is recommended to cool it down for one minute after 10 minutes' working.

Power Output Control

SET dial decides different power output, satisfying light requirements in different environment. The power is adjustable freely from 1/64 to 1/1 which will be accordingly shown on the LCD display. "OFF" on the display indicates that the flash triggering function is turned off. Press the test button to discharge power when the flash output is adjusted from high to low.

Test Button

To fire the flash without taking a picture, press the test button. It can also help adjust the flash brightness when combined with the SET dial.

Tip: Long press the SET dial and turn on the flash to view its version.

Sync Triggering

The sync cord jack is a $\Phi 3.5$ mm plug. Insert a trigger plug here and the flash will be fired synchronously with the camera shutter. Synchronously press the S1/S2 button and BUZZ button to recover factory settings.

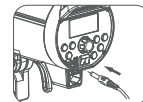

● GR/CH Button

Short press the GR/CH button can adjust the built-in wireless group. When the group indicator on the LCD panel is blinking, turn the SET dial to change. And long press the GR/CH button can adjust the built-in wireless channel. When the channel indicator on the LCD panel is blinking, turn the SET dial to change.

● Receiver Trigger Mode

Three receiver triggering modes are available and can be set by pressing <S1/S2> receiver model button.

◆ **No optical control:** S1 or S2 is not displayed on the LCD panel, indicating the receiver triggering function is shut down.

◆ **Optical S1** Secondary Unit Setting: In M manual flash mode, press <S1/S2> receiver mode button so that this flash can function as an optic S1 secondary flash with optic sensor. With this function, the flash will fire synchronously when the main flash fires, the same effect as that by the use of radio triggers. This helps create multiple lighting effects.

◆ **Optical S2** Secondary Unit Setting: Press <S1/S2> receiver mode button so that this flash can also function as an optic S2 secondary flash with optic sensor in M manual flash mode. This is useful when cameras have pre-flash function. With this function, the flash will ignore a single "pre-flash" from the main flash and will only fire in response to the second, actual flash from the main unit.

● Buzz Function

The BUZZ button is used for deciding whether there is sound reminder for ready flash after recharging. Short press the BUZZ button, when the buzz indicator is on the LCD panel, the buzz function is working; when it disappears, the buzz function is not working. A "BI" sound will be heard when it is fully charged.

● Wireless Button

Press the <W> Button can turn on/off the built-in wireless transmission. If there are no wireless and channel indicators displayed on the LCD panel, the built-in wireless transmission is off. On the contrary, the built-in wireless transmission is on. When turning the flash on, press the BUZZ button and C.Fn custom button simultaneously, and factory setting can be restored.

● C.Fn

F1	Wireless ID setting	Set it to 0F or choose any figure from 01 to 99. When setting to 0F, wireless ID will be turned off. And 01 to 99 means the wireless ID is turned on.
F2	Flash power display	It can be displayed in 1/P or P.P.

● Alarm Display

E0	The temperature sensor is not connected.
E3	Discharged capacitance and voltage > rating +10%
Alarm sounds	BIBI, ringing per 0.5 second. Press SET button to stop alarming.

Memory Function

The device is equipped with memory function for the panel setting. It will help remember the panel setting 3 seconds after you set it. When starting up the flash next time, the panel setting will be the same as that before powering it off.

Wireless Control Function

The flash unit has built-in 2.4G wireless transmission, which can be used together with X1, X2, XPro and XT16 or FT-16 flash trigger.

Press the <W> Button and the <S1/S2> Button can turn on the built-in wireless transmission and the <W> is displayed. If there are other wireless flash systems nearby, you can change the channel IDs to prevent signal interference. The channel IDs of the master unit and the receiver unit(s) must be set to the same.

Setting the Communication Channel

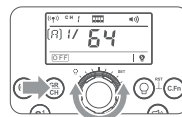

1 Long press the <GR/CH> Button for 2 seconds until the channel IDs is blinking.

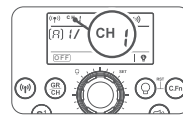

2 Turn the SET Dial to choose the channel from 1 to 32.

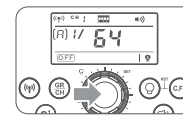

3 Press the SET Dial to confirm.

Setting the Communication Group

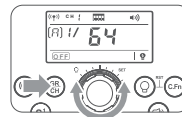

1 Short press the <GR/CH> Button for 2 seconds until the group IDs is blinking.

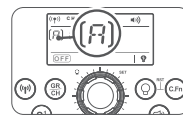

2 Turn the SET Dial to choose the group from 0 to F.

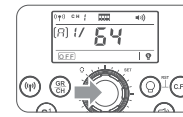

3 Press the SET Dial to confirm.

The flash unit is built in with a Wireless Control Port so that you can wirelessly adjust the power level of the flash and the flash triggering.

To control the flash wirelessly, you need a FT-16 remote control set (on-camera and on-flash). Insert its receive end into the Wireless Control Port on the flash and insert the transmit end into the camera hot shoe. Settings made on the hotshoe-mounted transmit and receive ends will be wirelessly communicated to the flash. Then you can press the camera shutter release button to trigger the flash. You can also hold the transmit end at hand to control your off-camera flash.

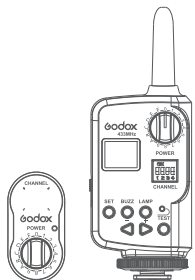

the two feet of the flash tube and pull out the old tube gently. Take down the feet casing from the old tube and put it on the new one. Hold two feet of the new tube, and target directly towards the two copper outlets, then push them slightly in. Twine the iron wire on the stainless steel sheet to fix the flash tube.



TECHNICAL DATA

Model	DP400IIIV	DP600IIIV	DP800IIIV	DP1000IIIV
Max Power (WS)	400Ws	600Ws	800Ws	1000Ws
Guide Number (ISO 100, in meters) (With high effective reflector)	87	106	126	140
Color Temperature	5800±200K			
Operating Voltage	100-240V~50/60Hz			
Power Output Control	OFF, 4.0~10.0(1/64~1/1)			
Modeling Lamp (W)	30W			
Triggering Method	Sync cord, Test button, receiver triggering, Wireless control port			
Flash Duration	1/2000~1/800s			
Parameters Output from the Sync Cord Jack	5V			
Parameters Output from the USB Port	5V/200mA (only for Godox receiver)			
Fuse	8A			
Recycle Time	0.1-1s			
Dimension	Flash diameter 12.5CM, height of flash with handle 21.5CM,			
	length of flash with lamp cover 38CM		length of flash with lamp cover 41CM	
Net Weight (Excluding cover)	Approx. 2.8kg	Approx. 2.8kg	Approx. 2.8kg	Approx. 3.4kg

For full instructions on the use of FT series remote control, see its user manual.

The Reason & Solution of Not Triggering in Godox 2.4G Wireless

1. Disturbed by the 2.4G signal in outer environment (e.g. wireless base station, 2.4G wifi router, Bluetooth, etc.)

→ To adjust the channel CH setting on the flash trigger (add 10+ channels) and use the channel which is not disturbed. Or turn off the other 2.4G equipment in working.

2. Please make sure that whether the flash has finished its recycle or caught up with the continuous shooting speed or not (the flash ready indicator is lightened) and the flash is not under the state of over-heat protection or other abnormal situation.

→ Please downgrade the flash power output. If the flash is in TTL mode, please try to change it to M mode (a preflash is needed in TTL mode).

3. Whether the distance between the flash trigger and the flash is too close or not

→ Please turn on the "close distance wireless mode" on the flash trigger (< 0.5m):

X1 and X2 series: press the test button and hold on, then turning it on until the flash ready indicator blinks for 2 times.

XPro series: Set the C.Fn-DIST to 0-30m.

4. Whether the flash trigger and the receiver end equipment are in the low battery states or not

→ Please replace the battery (the flash trigger is recommended to use 1.5V disposable alkaline battery).

• Tube Replacement

Shut down the power and remove the power cord before replacing the flash tube and wear insulated gloves. Then, loosen the iron wire on the tube, keep a balanced hold on

MAINTENANCE

- Shut down the device immediately when it works abnormally and find out the reason.
- Avoid sudden impacts and the lamp should be dedusted regularly.
- It is normal for the lamp to be warm when in use. Avoid continuous flashes if unnecessary.
- Maintenance of the flash must be performed by our authorized maintenance department
- which can provide original accessories. The flash-tube and the modeling lamp are user-replaceable. Replacement tubes and lamps can be obtained from the manufacturer.
- This product, except consumables e.g. flash tube and modeling lamp, is supported with a one-year warranty.
- Unauthorized service will void the warranty.
- If the product had failures or was wetted, do not use it until it is repaired by professionals.
- Disconnect the power when cleaning the flash or when changing the flashtube / modeling lamp.
- Changes made to the specifications or designs may not be reflected in this manual.

FCC

This device complies with part 15 of the FCC Rules. Operation is subject to the following two conditions: (1) This device may not cause harmful interference, and (2) this device must accept any interference received, including interference that may cause undesired operation.

Any Changes or modifications not expressly approved by the party responsible for compliance could void the user's authority to operate the equipment.

Note: This equipment has been tested and found to comply with the limits for a Class B digital device, pursuant to part 15 of the FCC Rules. These limits are designed to provide reasonable protection against harmful interference in a residential installation. This equipment generates uses and can radiate radio frequency energy and, if not installed and used in accordance with the instructions, may cause harmful interference to radio communications. However, there is no guarantee that interference will not occur in a particular installation. If this equipment does cause harmful interference to radio or television reception, which can be determined by turning the equipment off and on, the user is encouraged to try to correct the interference by one or more of the following measures:

- Reorient or relocate the receiving antenna.
- Increase the separation between the equipment and receiver.
- Connect the equipment into an outlet on a circuit different from that to which the

receiver is connected.

-Consult the dealer or an experienced radio/TV technician for help.

The device has been evaluated to meet general RF exposure requirement.

The device can be used in portable exposure condition without restriction.

Warning

Operating frequency: 2412MHz-2464.5MHz (only receive)

Declaration of Conformity

GODOX Photo Equipment Co.,Ltd. hereby declares that this equipment are in compliance with the essential requirements and other relevant provisions of Directive 2014/53/EU. In accordance with Article 10(2) and Article 10(10), this product is allowed to be used in all EU member states. For more information of DoC, Please click this web link: https://www.godox.com/DOC/Godox_DPIII-V_Series_DOC.pdf.

The device complies with RF specifications when the device used at 0mm from your body.

产品保修

尊敬的用户,本保修卡是申请保修服务的重要凭证,请您配合销售商填写并妥善保管,谢谢!

产品信息	型号	产品条码
用户信息	姓名	联系电话
	通信地址	
销售商信息	名称	
	联系电话	
	通信地址	
	销售日期	
备注		

注:此表应由销售商盖章确认。

不适用保修的情况

如产品存在下列情况,本文件项下的保证和服务将不适用①产品或部件超过相应保修期;②错误或不适当使用、维护或保管导致的故障或损坏,如:不当搬运;非按产品合理预期用途使用;不当插拔外接设备;跌落或外力挤压;接触或暴露于不当温度、溶剂、酸碱、水浸或潮湿环境;③由非神牛授权机构或人员安装、修理、更改、添加或拆卸造成的故障或损坏;④产品或部件原有识别信息被修改变更或除去;⑤无有效保修卡;⑥使用非法授权、非标准或非公开发行的软件造成的故障或损坏;⑦因不可抗力或意外事件造成的故障或损坏;⑧其他非因产品本身质量问题导致的故障或损坏。遇上述情况,您应向相关责任方寻求解决,神牛对此不承担任何责任。因非在保修期或保修范围内的部件、附件或软件导致产品不能正常使用的,不是保修范围内的故障。产品使用过程中正常的脱色、磨损和消耗,不是保修范围内的故障。

产品保修和服务支持信息

产品的保修期和服务类型按以下《产品保修信息》执行:

产品类别	选件名称	保修期(月)	保修服务类型
部件	电路板	12	客户送修
	电池	3	客户送修
	充电器等带电性能的部件。	12	客户送修
其他	如闪光灯管、造型灯泡、外壳、保护罩、锁紧装置、包装电源线,同步线等。	无	无保修

神牛产品售后服务电话:0755-29609320-8062

适用产品

本文件适用于相关《产品保修信息》(见后面说明)所列产品,其他非属此范围的产品或部件(如促销品、赠品及其他出厂后附加的部件等)不在此保修承诺内。

保修期

产品及部件的相应保修期按相关的《产品保修信息》执行。保修期自产品首次购买日起算,购买日以购买产品时保修卡登记日期为准。

如何获得保修服务

您可直接与产品销售商或授权服务机构联系,也可拨打神牛产品售后服务电话,与我们联系,由我们的服务人员为您安排服务。申请保修时,您应提供有效的保修卡作为保修凭证,方可获得保修。如您不能提供有效的保修卡,则在我们确认产品或部件属于保修范围的情况下,也可以为您提供保修,但这不作为我们的义务。

Warranty

Dear customers, as this warranty card is an important certificate to apply for our maintenance service, please fill in the following form in coordination with the seller and safe-keep it. Thank you!

Product Information	Model	Product Code Number
Customer Information	Name	Contact Number
	Address	
Seller Information	Name	
	Contact Number	
	Address	
	Date of Sale	
Note:		

Note: This form shall be sealed by the seller.

Applicable Products

The document applies to the products listed on the Product Maintenance Information (see below for further information). Other products or accessories (e.g. promotional items, giveaways and additional accessories attached, etc.) are not included in this warranty scope.

Warranty Period

The warranty period of products and accessories is implemented according to the relevant Product Maintenance Information. The warranty period is calculated from the day(purchase date) when the product is bought for the first time, And the purchase date is considered as the date registered on the warranty card when buying the product.

How to Get the Maintenance Service

If maintenance service is needed, you can directly contact the product distributor or authorized service institutions. You can also contact the Godox after-sale service call and we will offer you service. When applying for maintenance service, you should provide valid warranty card. If you cannot provide valid warranty card, we may offer you maintenance service once confirmed that the product or accessory is involved in the maintenance scope, but that shall not be considered as our obligation.

Inapplicable Cases

The guarantee and service offered by this document are not applicable in the following cases: ①. The product or accessory has expired its warranty period; ②. Breakage or damage caused by inappropriate usage, maintenance or preservation, such as improper packing, improper usage, improper plugging in/out external equipment, falling off or squeezing by external force, contacting or exposing to the improper temperature, solvent, acid, base, flooding and damp environments, etc; ③. Breakage or damage caused by non-authorized institution or staff in the process of installation, maintenance, alternation, addition and detachment; ④. The original identifying information of product or accessory is modified, alternated, or removed; ⑤. No valid warranty card; ⑥. Breakage or damage caused by using illegally authorized, nonstandard or non-public released software; ⑦. Breakage or damage caused by force majeure or accident; ⑧. Breakage or damage that could not be attributed to the product itself. Once met these situations above, you should seek solutions from the related responsible parties and Godox assumes no responsibility. The damage caused by parts, accessories and software that beyond the warranty period or scope is not included in our maintenance scope. The normal discoloration, abrasion and consumption are not the breakage within the maintenance scope.

Maintenance and Service Support Information

The warranty period and service types of products are implemented according to the following Product Maintenance Information:

Product Type	Name	Maintenance Period(month)	Warranty Service Type
Parts	Circuit Board	12	Customer sends the product to designated site
	Battery	3	Customer sends the product to designated site
	Electrical parts e.g.battery charger, etc.	12	Customer sends the product to designated site
Other Items	Flash tube, modeling lamp, lamp body, lamp cover, locking device, package, power cord, sync cable, etc.	NO	Without warranty

Godox After-sale Service Call 0755-29609320-8062