

合格证
QC PASS

Godox

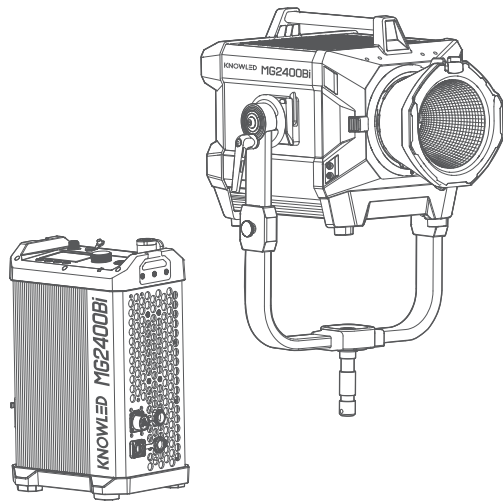

Wechat
Official Account
神牛微信公众号

说明书版本号: V1.1
控制盒固件版本号: V0.13
灯头固件版本号: V0.03

Instruction Manual Version: V1.1
Controller Firmware Version: V0.13
Lamp Head Firmware Version: V0.03

深圳市神牛摄影器材有限公司

地址: 深圳市宝安区福海街道塘尾社区耀川工业区厂房2栋 电话: 0755-29609320(8062)

传真: 0755-25723423 邮箱: godox@godox.com

GODOX Photo Equipment Co.,Ltd.

Add.: Building 2, Yaochuan Industrial Zone, Tangwei Community, Fuhai Street, Bao'an District,

Shenzhen 518103, China Tel: +86-755-29609320(8062) Fax: +86-755-25723423

E-mail: godox@godox.com

godox.com

Made in China | 705-MG24B0-03



KNOWLED
MG2400Bi

诺力双色温LED影视灯
KNOWLED Bi-color LED Light

使用手册
Instruction Manual

重要的安全说明及注意事项

首先作为最基本原则：本产品为专业灯光布景设备，应由专业灯光师使用或在专业人士指导下使用。使用时必须始终遵循基本的安全预防措施，具体安全预防措施如下：

1. 使用前必须阅读并理解产品说明书。
2. 专业灯具，禁止儿童使用。当儿童靠近时，家长或监护人必须密切监督，以免儿童因碰撞灯具或私用灯具造成人身伤害。
3. 本灯具并非普通照明灯具，不可用于普通照明，任何有过眼部损伤或眼部敏感的人群均应避免使用本灯具。
4. 灯具点亮时，必须小心使用，禁止接触高温部件，如LED灯珠，以免造成灼伤。
5. 灯具点亮时，任何情况下均禁止直视灯珠。应该在专业灯光师指导下使用强光，任何情况下避免长时间处于强光环境，如引起眼睛不适，请及时关闭灯具，暂停使用，请及时就医。
6. 倘灯具损坏或因热变形，应停止使用，并及时联系制造商、服务代理商或合格的维修人员更换灯珠，以免发生意外。
7. 本产品仅适用于-20°C~45°C工作温度环境下使用。
8. 请勿使用损坏的设备或设备配件，待专业维修人员检查维修，确认设备正常方可使用。
9. 在使用过程中，如果本产品由于跌落、受到挤压或遭受强烈冲击而造成外壳破裂的，请勿继续使用，以免因接触到内部电子元件而受到电击伤害。
10. 如需要延长线，请使用额定电流≥该设备额定电流的延长线。如延长线额定电流小于该设备，可能导致过热。
11. 产品电源线较长，请合理放置电源线，使其处于安全位置。避免电源线接触过热物体表面、避免放置不当导致拉扯损坏或绊倒现场人员。请使用原厂原装电源线，如使用非原厂电源线导致产品损坏，概不在本厂维修范围内。
12. 在清洁和维修之前，请务必从电源插座上拔下该设备插头。不使用时，禁止拉扯电源线以将设备插头从电源插座中拔出。正常断电，应是用手抓住该设备插头两端，将插头从电源插座中拔出。此设备需连接到接地插座中。
13. 请勿私自拆卸产品，如产品出现故障，须由本公司或授权的维修人员进行检查维修。
14. 存放本设备之前，请确保设备已完全冷却。存放时，将电源线从设备上拔出。设备应放置于设备便携包内或通风干燥处。
15. 请勿将设备放置在酒精、汽油等易挥发挥发的溶剂附近。
16. 本厂不推荐的产品附件，请勿使用，以免导致火灾、触电或人身伤害。
17. 清洁本设备时，请勿用湿布擦拭，请用干布、软布擦拭设备污垢。
18. 设备使用前，请注意将保护罩取下。
19. 本产品已通过ROHS, CE和FCC认证，请参考相关国家标准使用和操作。
20. 安全说明依据本厂严格测试制定，设备设计和规格如有变更，恕不另行通知。客户可以上神牛官网查看最新的电子版说明，了解产品最新资讯。
21. 一年保修期，消耗品适配器、电源线等配件不在此保修范围内。
22. 经发现，擅自检修设备，将取消一年保修期，维修需要收取相关费用。
23. 对于不规范操作引起的机器故障不在保修范围内。

保存这些说明

前言

感谢您购买神牛产品。

神牛全新推出一款超大功率 LED 影视灯 MG2400Bi, 输入功率高达 2900W, 支持 100V-240V-50/60Hz 供电, 可在全球范围内使用; 拥有超高亮度、灯体与控制器分离、千分级亮度调节、IP54 级防水防尘、4 种调光曲线、2800K-6500K 色温、平均 CRI≥96, 平均 TLCI≥96, 多种无线控制等诸多特性; 适用于大型摄影棚、影视基地、演播室、户外外景、大型实地场等拍摄场景。

主要特点

- 2600W超强输出功率，全色温段段功率输出；
- 真正的千分级调节，能从100%完美平滑调光至0%；
- 宽广色温，调节范围：2800K-6500K；
- 超高显色指数，平均CRI≥96，平均TLCI≥96；
- 4种调光曲线：线性、S曲线、指数、对数；
- 多种无线控制方式，如DMX 512控制台控制/LumenRadio CRMX控制/蓝牙App控制；
- 全新神牛G卡口，通信触点，智能识别附件，提高大功率灯具的安全系数；
- 灯头及控制器均有IP54级防护设计，防止粉尘进入的同时，支持任何角度泼水；
- 采用高效散热大风扇，配合全散散热设计，满足了大灯具散热需求；
- 11类FX光效模式：闪光灯、雷闪电、多云、坏灯泡、电视机、蜡烛、火、烟花、爆炸、焊接、SOS。

警告

- ▲ 大功率LED灯，严禁直视光源或照射他人眼睛。
- ▲ 严禁通电时插拔电源线，以免造成人身伤害。
- ▲ 本灯具工作时，请勿遮挡散热口。
- ▲ 请勿让儿童靠近、接触或使用本灯具。
- ▲ 专业灯光设备，请务必按照使用手册正确操作。



人眼不可直视

部件名称

灯体

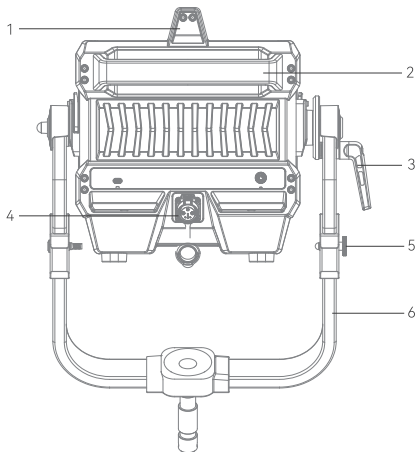

1. 提手1
2. 提手2
3. 方向调节把手
4. DC输入接口
5. 挂绳装置
6. U型支架
7. 卡口推制
8. 神牛G卡口
9. 快装装置

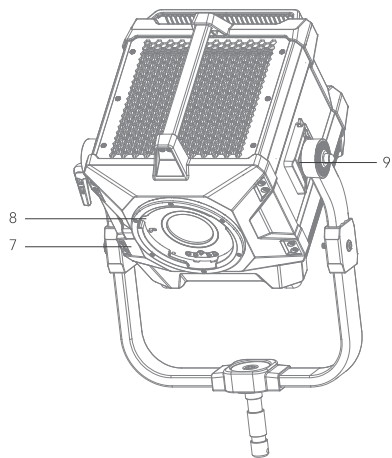

03

控制器

1. 天线接口
2. 离机遥控器接口
3. DC输出接口
4. PRESET按键
5. LOCK按键
6. MENU按键
7. MODE按键
8. 调节旋钮
9. 无线CRMX指示灯
10. 开关按键
11. 彩屏
12. DMX OUT接口
13. DMX IN接口
14. AC输入接口
15. 以太网接口

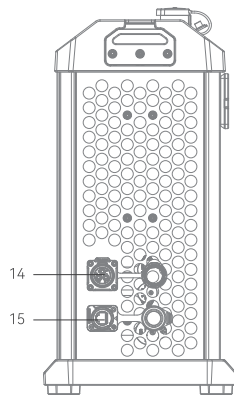
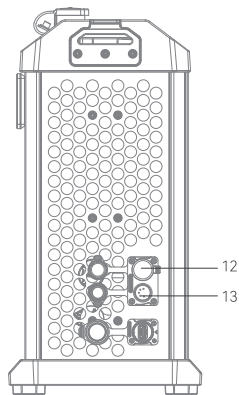
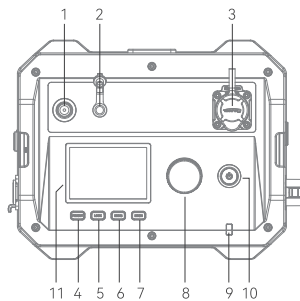

04

MG2400Bi物品清单

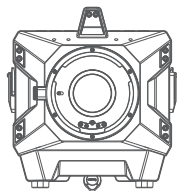

灯体×1

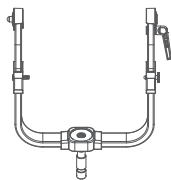

U型支架×1

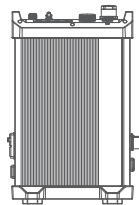

控制器×1

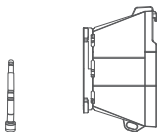

天线×1

反光罩×1



控制器固定件×1



灯头保护罩×1



安全绳×1

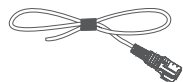

电源线×1



DC连接线×1



绑绳×1



DMX实用表×1



说明书×1

MG2400Bi K1物品清单

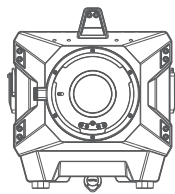

灯体×1

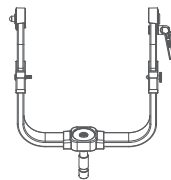

U型支架×1

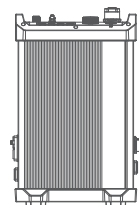

控制器×1

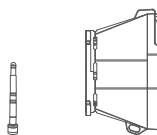

天线×1

反光罩×1



控制器固定件×1



灯头保护罩×1



安全绳×1

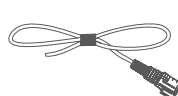

电源线×1



DC连接线×1



绑绳×1



DMX实用表×1



说明书×1



灯体箱包SC18×1



附件箱包SC19×1

MG2400Bi K2物品清单

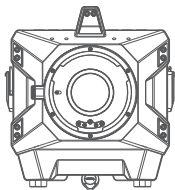

灯体×1

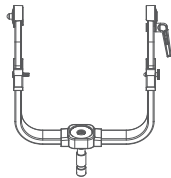

U型支架×1

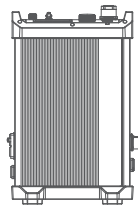

控制器×1



天线×1

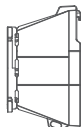

反光罩×1



控制器固定件×1



灯头保护罩×1



安全绳×1



电源线×1



DC连接线×1



绑线绳×1



DMX实用表×1



说明书×1



航空箱 ×1

温馨提示：说明书中线图均为示意图，仅供参考。由于产品不断更新与升级，产品实物与线图可能存在差异，请以实物为准。

可另购附件

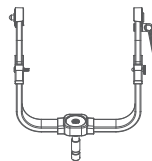

U架G2400BY01

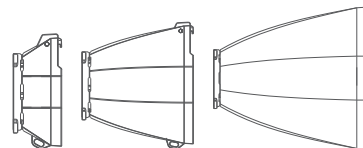

反光罩套装GRK

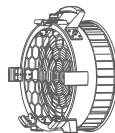

菲涅尔镜头（手动）GF14



八角柔光箱GO3

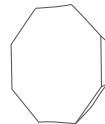

八角柔光箱GO4

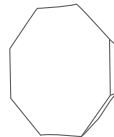

八角柔光箱GO5



深口柔光箱GP3



深口柔光箱GP4



深口柔光箱GP5

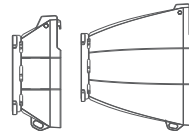

反光罩套装GRK2

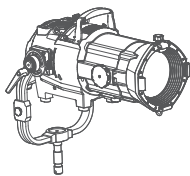

投影筒GP19K

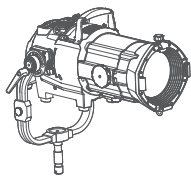

投影筒GP26K

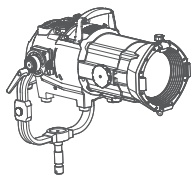

投影筒GP36K



收纳包SC18



收纳包SC19

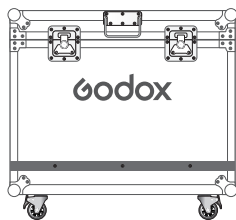

航空箱FC05

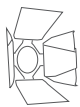

遮菲GR45B

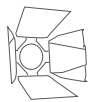

遮菲GR30B

相关安装与拆卸

1. 安装U型支架

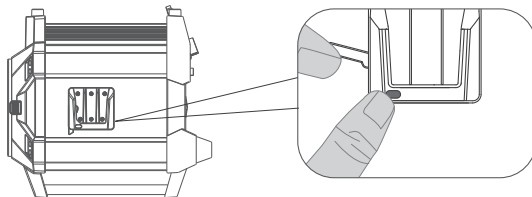

1.1 将灯具放于平面上，散热面朝上。

1.2 按住快装置按钮，拨开扳手。

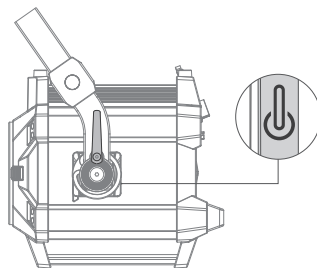

1.3 将U型支架两端对准快装置插入，接着将两边扳手锁紧，听到“咔”一声即表示安装完毕。

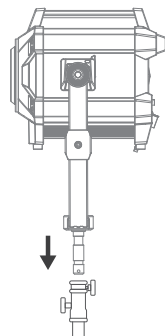

1.4 将灯具安装在滚轮灯架上，锁紧滚轮灯架的固定旋钮。

注：滚轮灯架不包含在标配内，需另购。

▲ 该灯具重量大，安装需小心谨慎，以免造成人身伤害。

2. 拆卸U型支架

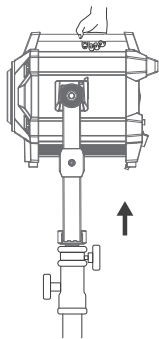

2.1 握住灯具的提手，将灯具从滚轮灯架上取下来放在平面上。

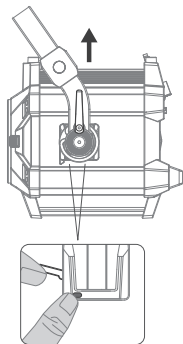

2.2 按住快装置按钮，拨开扳手，即可将U型支架取出。

3. 安装/拆卸灯头保护罩

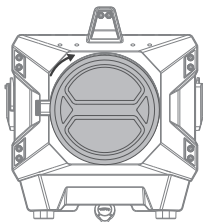

3.1 将灯头保护罩对准灯头卡口，顺时针旋转即可安装完毕

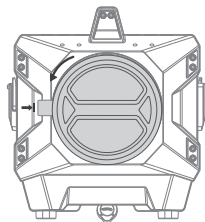

3.2 按住卡口推制，逆时针旋转即可取下灯头保护罩。

4. 安装/拆卸反光罩

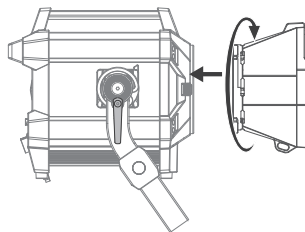

4.1 将反光罩对准灯头卡口，插入后顺时针旋转即可安装完毕。

注：请务必对准卡口插入

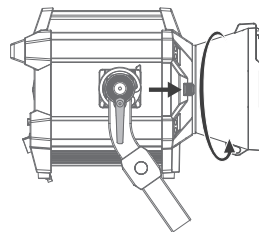

4.2 按住卡口推制，逆时针旋转即可取下灯头反光罩。

5. 将控制器安装到灯架上

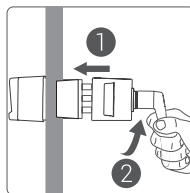
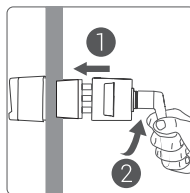

5.1 将控制器固定件把手拧松后插入灯架杆，顺时针旋转把手锁定固定件，最后将控制器快装装置对准固定件卡槽插入即可。

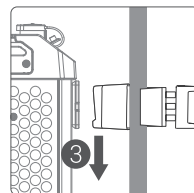

6. AC电源线接线说明

1号黄线为地线，2号黑线为零线，3号红线为火线，请您根据对应的线路连接插头后使用。

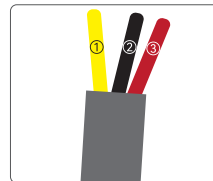

7. 连接DMX控制台

7.1 无线DMX连接

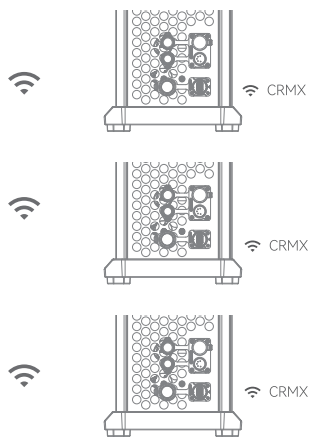
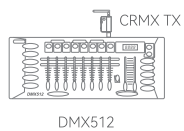

7.2 有线DMX连接

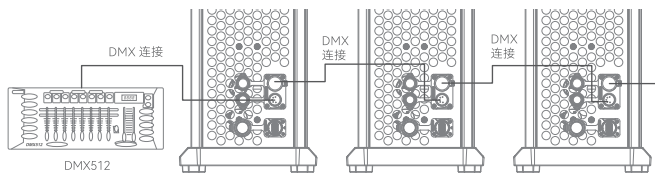

注：DMX连接线需另购。

8. 连接以太网

连接一

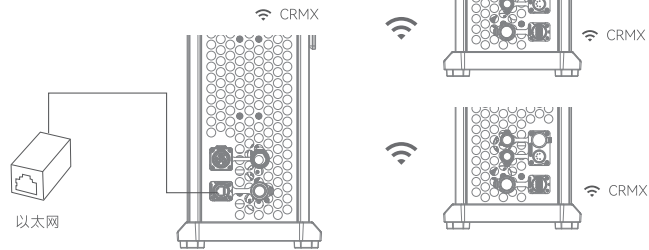

连接二

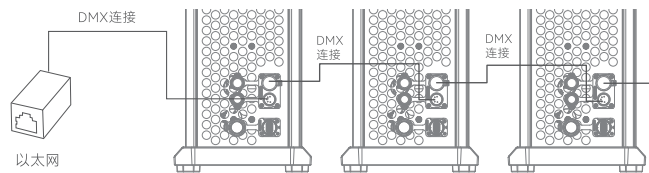

供电

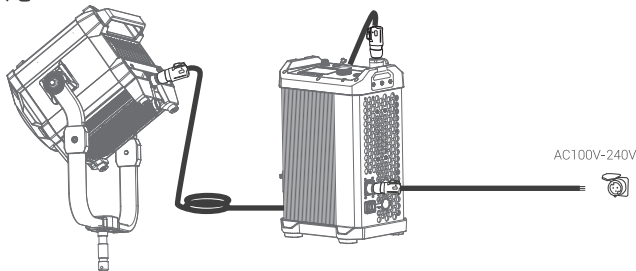

注：严禁通电时插拔电源线或连接线，以免造成意外

开关机

接通电源，短按控制器开关按键，实现开机或关机。

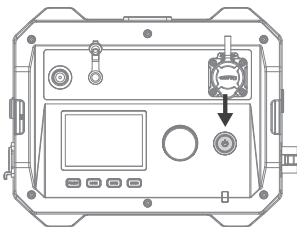

色温模式

短按MODE按键切换至色温模式。短按调节旋钮可切换亮度设置界面/色温设置界面。

切换至亮度设置界面，旋转调节旋钮调节亮度百分比，调节范围为0%-100%。

常规旋转，顺时针旋转一次调节按钮增加0.1个单元值，逆时针旋转一次调节按钮减少0.1个单元值；支持快调。

切换至色温设置界面，旋转调节旋钮调节色温值，调节范围为2800K-6500K。

常规旋转，顺时针旋转一次调节按钮增加100个单元值，逆时针旋转一次调节按钮减少100个单元值。

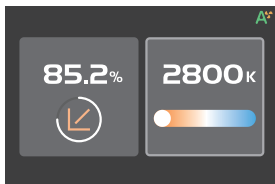

FX光效模式

短按MODE按键切换至FX光效模式。旋转调节旋钮依次选择闪光灯/雷闪电/多云/坏灯泡/电视机/蜡烛/火/烟花/爆炸/焊接/SOS等11类场景光效。

选中所需光效，短按调节按键进入光效设置界面。



1. 闪光灯光效

进入闪光灯光效，旋转调节旋钮选择开关、亮度百分比、色温、自动、手动、速度、闪光灯模式等选项。短按调节旋钮选中选项，旋转调节旋钮可调节选项（自动、手动等选项除外）。设置完毕，长按调节旋钮/短按MODE按键返回上一级。

注：选中手动，通过短按一次调节旋钮触发一次闪光灯光效。

具体调节参数如下：

开关：开启光效/关闭光效

亮度：0%-100%

色温：2800K-6500K

速度：1-100

闪光灯模式：模拟闪光灯光效/模拟镁光灯光效

2. 雷闪电光效

进入雷闪电光效设置，旋转调节旋钮选择开关、亮度百分比、色温、自动、手动、闪烁次数、频率等选项。短按调节旋钮选中选项后，旋转调节旋钮可调节选项参数（自动、手动等选项除外）。设置完毕，长按调节旋钮/短按MODE按键返回上一级设置。

注：选中手动，通过短按一次调节旋钮触发一次雷闪电光效。

具体调节参数如下：

开关：开启光效/关闭光效

亮度：0%-100%

色温：2800K-6500K

闪烁次数：随机/1-10

频率：随机/2-20

3. 多云光效

进入多云光效设置，旋转调节旋钮选择开关、亮度百分比、亮暗比例、速度等选项。短按调节旋钮选中选项后，旋转调节旋钮可调节选项参数。设置完毕，长按调节旋钮/短按MODE按键返回上一级。

具体调节参数如下：

开关：开启光效/关闭光效

亮度：0%-100%

亮暗比例：10%-90%

速度：随机/1-100

4. 坏灯泡光效

进入坏灯泡光效设置，旋转调节旋钮选择开关、亮度百分比、色温、速度等选项。短按调节旋钮选中选项后，旋转调节旋钮可调节选项参数。设置完毕，长按调节旋钮/短按MODE按键返回上一级。

5. 电视机光效

进入电视机光效设置，旋转调节旋钮选择开关、亮度百分比、速度等选项。短按调节旋钮选中选项后，旋转调节旋钮可调节选项参数。设置完毕，长按调节旋钮/短按MODE按键返回上一级。

6. 蜡烛光效

进入蜡烛光效设置，旋转调节旋钮选择开关、亮度百分比、速度等选项。短按调节旋钮选中选项后，旋转调节旋钮可调节选项参数。设置完毕，长按调节旋钮/短按MODE按键返回上一级。

7. 火光效

进入火光效设置，旋转调节旋钮选择开关、亮度百分比、速度等选项。短按调节旋钮选中选项后，旋转调节旋钮可调节选项参数。设置完毕，长按调节旋钮/短按MODE按键返回上一级。

8. 烟花光效

进入烟花光效设置，旋转调节旋钮选择开关、亮度百分比、速度、余烬等选项。短按调节旋钮选中选项后，旋转调节旋钮可调节选项参数。设置完毕，长按调节旋钮/短按MODE按键返回上一级。

具体调节参数如下:
开关: 开启光效/关闭光效
亮度: 0%-100%
色温: 2800K-6500K
速度: 1-100

具体调节参数如下:
开关: 开启光效/关闭光效
亮度: 0%-100%
速度: 1-100

具体调节参数如下:
开关: 开启光效/关闭光效
亮度: 0%-100%
速度: 1-100

具体调节参数如下:
开关: 开启光效/关闭光效
亮度: 0%-100%
速度: 1-100

具体调节参数如下:
开关: 开启光效/关闭光效
亮度: 0%-100%
速度: 1-100
余烬: 01-100

9. 爆炸光效

进入爆炸光效设置，旋转调节旋钮选择开关、亮度百分比、色温、自动、手动、速度、余烬等选项。短按调节旋钮选中选项后，旋转调节旋钮可调节选项参数（自动、手动等选项除外）。设置完毕，长按调节旋钮/短按MODE按键返回上一级。

注: 选中手动，通过短按一次调节旋钮触发一次爆炸光效。

10. 焊接光效

进入焊接光效设置，旋转调节旋钮选择开关、亮度百分比、色温、速度等选项。短按调节旋钮选中选项后，旋转调节旋钮可调节选项参数。设置完毕，长按调节旋钮/短按MODE按键返回上一级。

具体调节参数如下:
开关: 开启光效/关闭光效
亮度: 0%-100%
色温: 2800K-6500K
速度: 1-100
余烬: 1-100

具体调节参数如下:
开关: 开启光效/关闭光效
亮度: 0%-100%
色温: 2800K-6500K
速度: 1-100

11. SOS光效 SOS

进入SOS光效设置，旋转调节旋钮选择开关、亮度百分比、色温等选项。短按调节旋钮选中选项后，旋转调节旋钮可调节选项参数。设置完毕，长按调节旋钮/短按MODE按键返回上一级。

注: 使用FX场景光效时，调光曲线默认为线性

具体调节参数如下:
开关: 开启光效/关闭光效
亮度: 0%-100%
色温: 2800K-6500K

菜单设置

短按MENU按键进入菜单设置，旋转调节旋钮选择DMX、CRMX、蓝牙、以太网、Art-Net&sACN、附件识别、功率限制、调光曲线、风扇、屏幕设置、语言、版本与升级、恢复出厂设置、灯具信息。



1.DMX

短按调节旋钮进入DMX设置界面，旋转调节旋钮选择地址/DMX模式/RDM状态/DMX状态/终止开关/增强通道。短按调节旋钮进入选项设置，通过旋转调节旋钮完成选项设置。选项设置完毕，短按调节按钮可退出选项设置，短按MENU按键返回上一级。



连接DMX, 控制器显示界面

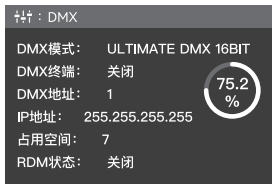

连接CRMX, 控制器显示界面

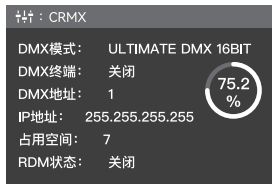

一级选项	二级选项	说明
地址	1-512	起始地址
DMX模式	01:CCT 8 Bit	8位CCT模式
	02:FX 8 Bit	8位FX模式
	03:CCT 16 Bit	16位CCT模式
	04:FX 16 Bit	16位FX模式
	05:ULTIMATE DMX 8 Bit	8位 DMX模式
	06:ULTIMATE DMX 16 Bit	16位 DMX模式
RDM状态	开启	开启RDM
	关闭	关闭RDM
DMX丢失状态	保持最后状态	失去DMX控制信号后, 在关机或再次接收有效DMX控制信号前, 持续使用最后一次接收的DMX控制信号
	直接关闭	灯头直接熄灭
	保持最后状态2分钟后熄灭	失去DMX控制信号后, 持续使用最后一次接收的DMX控制信号2分钟, 2分钟后灯头熄灭。注: 如2分钟内接收到有效DMX控制信号, 则使用新的DMX控制信号。
终止开关	开启	开启DMX终端
	关闭	关闭DMX终端
增强通道	开启	开启增强通道信号
	关闭	关闭增强通道信号

注: 使用DMX/RDM控制台控制灯具, 可参照附件《DMX实用表》。电子版可登录官网<https://www.godox.com.cn>下载。

2. CRMX

短按调节旋钮进入CRMX设置界面。旋转调节旋钮选择CRMX开关/模式。短按调节旋钮进入选项设置，通过旋转调节旋钮完成选项设置。选项设置完毕，短按调节按钮可退出选项设置，短按MENU按键返回上一级。

注：选择发射模式/接收模式前，先进行复位。



CRMX发射模式界面



CRMX接收模式界面

一级选项	二级选项	说明
CRMX	开启	开启CRMX
	关闭	关闭CRMX
模式	发射模式	CRMX开启发射模式
	接受模式	CRMX开启接收模式
发射功率	5dBm	仅发射模式下可调, 发射功率值为5dBm
	11dBm	仅发射模式下可调, 发射功率值为11dBm
	16dBm	仅发射模式下可调, 发射功率值为16dBm
	20dBm	仅发射模式下可调, 发射功率值为20dBm
连接状态	启动连接	仅发射模式下可调, 启动连接状态
	连接中	仅发射模式下可调, 正在连接

3. 蓝牙

短按调节旋钮进入蓝牙设置界面。旋转调节旋钮选择蓝牙开关/蓝牙重置，短按调节旋钮进入设置，通过旋转调节旋钮完成设置。设置完毕，短按MENU按键返回上一级。扫描二维码即可下载“Godox Light”手机App（安卓和苹果系统都可以使用）



注：首个移动设备（手机或平板电脑）可直接使用App操控灯体。更换其他移动设备时，灯体需进行蓝牙重置方可正常使用App。App需升级至V3.0以上版本。

4. 以太网

短按调节旋钮进入以太网设置界面。旋转调节旋钮至网络模式，短按调节旋钮进入网络模式设置界面，旋转调节旋钮选择DHCP/Art-Net 2.x/Art-Net 10.x/手动。设置完毕，短按MENU按键返回上一级。



Godox KNOWLED App

一级选项	二级选项	说明
网络模式	DHCP	使用DHCP模式
	Art-Net 2.x	使用2.B.C.D网络
	Art-Net 10.x	使用10.B.C.D网络
	手动	可手动设置网络IP、子网掩码、默认网关
IP	AAA.BBB.CCC.DDD	如果启动DHCP模式, 灯光ID地址则有DHCP分配。 如果启动Art-Net 2.x模式, 灯光ID地址则为2.B.C.D。 如果Art-Net 10.x模式, 灯光ID地址则为10.B.C.D。 如果启动手动模式, AAA=0-255 BBB=0-255 CCC=0-255 DDD=0-255
	255.BBB.CCC.DDD	如果启动DHCP/Art-Net 2.x/Art-Net 10.x, 子网掩码为255.BBB.CCC.DDD不能通过菜单更改。 如果启动手动, AAA=0-255 BBB=0-255 CCC=0-255 DDD=0-255
默认网关	AAA.BBB.CCC.DDD	如果启动DHCP模式, 灯光默认网关则有DHCP分配。 如果启动Art-Net 2.x模式, 灯光默认网关地址则为2.B.C.D。 如果Art-Net 10.x模式, 灯光默认网关则为10.B.C.D。 如果启动手动模式, AAA=0-255 BBB=0-255 CCC=0-255 DDD=0-255

5. Art-Net&sACN

短按调节旋钮进入Art-Net&sACN协议设置界面。旋转调节旋钮至Art-Net&sACN，短按调节旋钮进入Art-Net&sACN设置界面，旋转调节旋钮选择自动/Art-Net/sACN/关。选择协议选项后，可继续进行其他二级选项设置。设置完毕，短按MENU按键返回上一级。

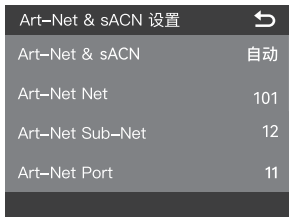

一级选项	二级选项	说明
Art-Net&sACN	自动/Art-Net/sACN/关	自动：接受Art-Net&sACN两种协议。 Art-Net：只接受Art-Net协议。 sACN：只接受sACN协议。 关：不接受网络协议。
Art-Net Net	0-127	选择Art-Net网络
Art-Net Sub-Net	0-15	在Art-Net网络中选择Art-Net子网
Art-Net Port	0-15	Art-Net端口
Art-Net Universe	0...32767	Art-Net域
sACN Universe	1...63999	sACN域

6. 附件识别

短按调节旋钮进入附件识别设置界面。短按调节旋钮后旋转调节旋钮选择开启/关闭。设置完毕，短按MENU按键返回上一级。

注：附件识别开启后，附件未安装到位，灯具不会亮。

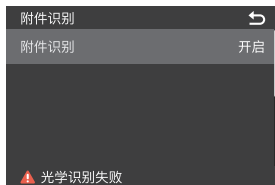

7. 功率限制

短按调节旋钮进入功率限制设置界面。旋转调节旋钮选择功率限制或最大限制。短按调节旋钮进入设置，通过旋转调节旋钮完成设置。设置完毕，短按MENU按键返回上一级。

最大限制：10%-100%

注：在供电环境无法满足开机状态下，在关机状态下启动此功能，同时按压预设按键+MODE按键，开机自动进入功率限制模式（默认功率限制50%）。

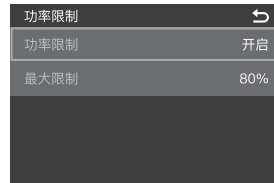

8. 调光曲线

短按调节旋钮进入调光曲线设置界面。旋转调节旋钮选择线性、S曲线、指数、对数。选择完毕，短按调节旋钮/短按MENU按键返回上一级。



9. 风扇

短按调节旋钮进入风扇设置界面。旋转调节旋钮选择静音、自动、中速、高速模式。选择完毕，短按调节旋钮/短按MENU按键返回上一级。



10. 屏幕设置

短按调节旋钮进入屏幕设置界面。短按调节旋钮后旋转调节旋钮设置屏幕亮度值，调节范围为10%-100%。设置完毕，短按MENU按键返回上一级。



11. 语言

短按调节旋钮进入语言设置。旋转调节旋钮选择中文/English，短按调节旋钮完成设置。设置完毕，短按MENU按键返回上一级。



12. 版本与升级

短按调节旋钮进入版本与升级界面，在此界面可查看灯头固件版本、控制器固件版本及升级固件提示。查看完毕，短按MENU按键返回上一级。



13. 恢复出厂设置

短按调节旋钮进入恢复出厂设置界面。旋转调节旋钮选择确定/取消，短按调节旋钮完成设置。确认恢复出厂设置后，灯体会重启，界面自动出现简体中文和English选项，旋转旋钮选择某项后短按旋钮完成设置，此时灯体亮度值自动变为100%且界面返回到色温模式界面。



14. 灯具信息

短按调节旋钮进入灯具信息界面，在此界面可查看灯具型号、UID号、灯头固件版本、控制器固件版本、灯头温度、灯体保养时间提示、认证信息等。查看完毕，短按MENU按键返回上一级。

当灯体显示灯头保养时间剩余为0小时，客户需要对灯头玻璃处或其他部位进行清洁，建议使用干布或软布擦拭设备污垢。保养完毕，您选择复位后，灯头保养时间将重新计时。



锁定设置

短按LOCK按键，屏幕出现表示当前界面被锁定；再次短按LOCK按键便可解锁。

注：此锁定功能仅锁定控制器操控面板，其他操作方式仍可正常操作。



预存设置

短按PRESET按键进入预存灯具光效界面。旋转调节旋钮选择1-20组预设，短按调节旋钮进入预设组设置，通过旋转调节旋钮可选应用/保存/取消，最后短按调节旋钮完成设置。设置完毕，短按PRESET按键退出预存设置。

应用：应用该组预设光效。

保存：保存当前灯具光效。

取消：返回上一级。

注：某组预设如未预设过光效，界面不显示应用选项。



软件升级

1. 控制器固件升级

1.1 在官网 (<https://www.godox.com.cn/firmware-continuous-light>) 下载新固件到U盘上。

1.2 在关机的状态下，将存有新固件的U盘插入 USB-A接口。

1.3 开机，MG2400Bi影视灯控制器自动进入升级界面。

1.4 升级完毕自动跳回主界面。

2. 灯头固件升级

2.1 在官网 (<https://www.godox.com.cn/firmware-continuous-light>) 下载新固件到U盘上。

2.2 在关机的状态下，将存有新固件的U盘插入 USB-C接口。

2.3 开机，MG2400Bi影视灯头自动进入升级界面。

注：1. 必须在官网下载新固件，存放在U盘根目录下，而且仅有一个BIN文件。

2. USB-A接口支持供电，输出电压电流5V/1.5A，请勿接入大功率USB设备。

维护保养

一年保修期，消耗品电池，适配器，电源线等配件不在此保修范围内。

经发现，擅自检修此LED影视灯，将取消LED影视灯一年保修期，维修需要收取相关费用。

对于不规范操作引起的机器故障不在保修范围内。

所有维修一概由本厂指定的可供原配件的维修部负责。

如本品出现故障或者被水淋湿，在专业人员维修后方可继续使用。LED影视灯在工作时，如发现异常，应立即关掉电源，查明原因。

照度数据

色温	测试条件	照度单位	3m	5m	7m	9m	10m
2800K	裸灯	lux	≈8810	≈3540	≈2120	≈1480	≈1250
		fc	≈818	≈329	≈197	≈137	≈116
3200K	裸灯	lux	≈9700	≈3950	≈2360	≈1640	≈1380
		fc	≈901	≈367	≈220	≈152	≈128
4300K	裸灯	lux	≈11600	≈4740	≈2840	≈1920	≈1650
		fc	≈1080	≈440	≈264	≈179	≈153
5600K	裸灯	lux	≈12000	≈4890	≈2900	≈1970	≈1700
		fc	≈1120	≈454	≈269	≈183	≈158
6500K	裸灯	lux	≈11300	≈4650	≈2730	≈1870	≈1600
		fc	≈1050	≈432	≈254	≈174	≈149

色温	测试条件	照度单位	3m	5m	7m	9m	10m
2800K	带标配置(45°)	lux	≈32200	≈11700	≈6240	≈4000	≈3380
		fc	≈2990	≈1090	≈580	≈372	≈314
3200K	带标配置(45°)	lux	≈35900	≈13000	≈6900	≈4450	≈3740
		fc	≈3340	≈1200	≈641	≈413	≈348
4300K	带标配置(45°)	lux	≈43200	≈15700	≈8340	≈5370	≈4490
		fc	≈4020	≈1460	≈775	≈499	≈417
5600K	带标配置(45°)	lux	≈44600	≈16200	≈8590	≈5520	≈4650
		fc	≈4140	≈1500	≈798	≈513	≈432
6500K	带标配置(45°)	lux	≈42100	≈15300	≈8110	≈5260	≈4400
		fc	≈3910	≈1420	≈753	≈489	≈408

以上数据非绝对值，为平均值，测试皆在灯体100%亮度下进行。

规格参数

型号	MG2400Bi
供电	100V-240V~50/60Hz 30A(Max.)
最大输入功率	≈2900W
色温	2800-6500K
调光范围	0%-100%
调光模式	线性/曲线/指数/对数
光效模式	11类
CRI	平均≥96
TLCI	平均≥96
灯体/控制器防水等级	IP54
控制方式	DMX 512控制台控制, 支持RDM协议/LumenRadio CRMX控制/蓝牙App控制/以太网支持 Art-Net & sACN协议/离机遥控器控制/灯体控制 (离机遥控器RC11需另购)
蓝牙控制距离	最远100m
USB-A接口	固件升级/5V = 1.5A供电
尺寸 (灯体不包含U型支架和反光罩)	灯体: 409mm×385 mm×356mm 控制器: 280mm×420mm×210mm
净重*	灯体 (不包含U型支架和反光罩): 20kg 控制器: 13kg

设计和规格如有变更, 恕不另行通知。

本设备包含型号核准代码为: CMIIT ID:23J44811A003,为该产品的无线电发射模块。

Important Safety Instructions and Precautions

First of all, as the most basic principle: This product is a professional lighting set equipment and should be used by professional lighting engineers or under the guidance of professionals. Basic safety attentions must always be followed during use, as follows:

1. Before use, please read and understand these instructions and attentions.
2. Professional lighting is prohibited for children. When children are near, parents or accompanying persons must supervise closely to prevent children from personal injury due to collision with lamps or private use of lamps.
3. This lighting product is not ordinary lighting product and cannot be used for general lighting. Anyone who has suffered eye damage or has sensitive eyes should avoid using this product.
4. When the lamp is on, it must be used with care. Do not touch high-temperature parts, such as LED lamp beads, to avoid burns.
5. When the lamp is on, it is forbidden to look directly at the lamp beads under any circumstances. Strong light should be used under the guidance of professional lighting engineers. Avoid prolonged exposure to strong light under any circumstances. If eye discomfort, please turn off the lamp in time, suspend use, and see a doctor immediately.
6. If the lamp bead is damaged or deformed by heat, stop using this equipment, and contact the manufacturer, service agent or qualified maintenance personnel to replace the lamp bead in time to avoid accidents.
7. This product is only suitable for use in -20°C to 45°C operating environment and normal humidity environment.
8. Do not use damaged equipment or accessories, and wait for professional maintenance personnel to check and repair to confirm being normal before use.
9. During using, if the casing of this product is broken due to being dropped, squeezed or subjected to strong impact, please do not use it, so as to avoid electric shock injury due to contact with internal electronic components.
10. If an extension cord is required, please use an extension cord with a current rating greater than or equal to that of the equipment. If an extension cord is rated less than the equipment, overheating may result.
11. Some products have long power cords, please place the power cords properly and keep them in a safe place. Avoid contacting the power cord with overheating surfaces, avoid improper placement that could cause pulling damage, or trip on-site personnel. Please use the certified power cord from the original manufacturer. If the product is damaged by using a non-certified power cord, it will not be repaired by our factory.
12. Be sure to unplug equipment from the power outlet before cleaning and repairing. When not in use, do not pull the power cord to unplug the equipment. For normal power-off, please hold both ends of the plug of the equipment with your hands and pull the plug out of power outlet. This equipment needs to be connected to a grounded outlet.
13. Do not disassemble the product without permission. If the product fails, it must be checked and repaired by authorized maintenance personnel.
14. Before storing, make sure that the equipment has cooled down completely. For storage, unplug the power cord from the equipment. The equipment should be placed in the carrying case or in a ventilated dry place.

15. Do not place equipment near flammable and volatile solvents such as alcohol and gasoline.
16. Do not use accessories that are not recommended by our factory to avoid fire, electric shock or personal injury.
17. When cleaning, do not wipe it with a damp cloth, please use a dry cloth or a soft cloth to wipe the dirt of the equipment.
18. Please take off the protective cover before using.
19. This product complies with ROHS, CE, and FCC certification, please refer to the relevant national standards for use and operation.
20. The safety instructions are formulated according to the strict testing of the factory, and the design and specifications of the equipment are subject to change without prior notice. For latest product information, please check the GODOX website and view latest electronic instruction.
21. One-year warranty period, accessories such as consumable batteries, adapters, power cords, etc. are not covered by this warranty.
22. If it is found that the equipment is repaired without authorization, the one-year warranty period will be cancelled and relevant fees will be charged for maintenance.
23. Machine failures caused by non-standard operation are not covered by the warranty.

keep these instructions!

Forword

Thank you for purchasing!

MG2400Bi is a brand new high power LED light, with the following powerful features and functions: input power of 2900W, support 100V-240V~50/60Hz power supply which allows you to use it anywhere in the world, ultra-high and thousand-bit adjustable brightness, separate design of light body and controller, IP54 rate, four dimming curves, wide CCT range from 2800K to 6500K, CRI \geq 96 & TLCI \geq 96, various wireless controlling methods, and etc. This new product is suitable for shooting scenes in large-scale photography studios, film and television studios, broadcast studios, outdoor exteriors and large field scenes.

Main Features

- 2600W strong output power in full CCT range.
- Thousand-bit adjustable brightness from 0% to 100%.
- Wide CCT range adjustable from 2800K to 6500K.
- Super high CRI: CRI \geq 96, TLCI \geq 96
- Four dimming curves: linear, S-curve, exponential, logarithmic.
- Various wireless controlling methods: support DMX 512/LumenRadio CRMX/Bluetooth App control.
- With the brand new Godox G-Mount, communication contacts and intelligent accessory recognition, the safety index for the use of high-power lighting fixture is significantly improved.
- IP54 rate keeps the light head and controller from dust and water.
- Adopt efficient heat dissipation system design with large fan to meet the cooling needs of large LED light.
- 11 FX modes: flash, lightning, cloudy, broken bulb, TV, candle, fire, firework, explosion, welding, SOS.

Warning

- ▲ Do not look directly at the LED light or illuminate at others' eyes.
- ▲ Do not plug or unplug the power cable or connecting cable when the power is turned on, otherwise personal injuries may occur.
- ▲ Do not cover the heat dissipation vent in working status.
- ▲ Keep out of reach of children.
- ▲ Please make sure to follow the instruction manual and correctly use this professional lighting device.



Don't stare at a bright light source

Name of Parts

Light Body

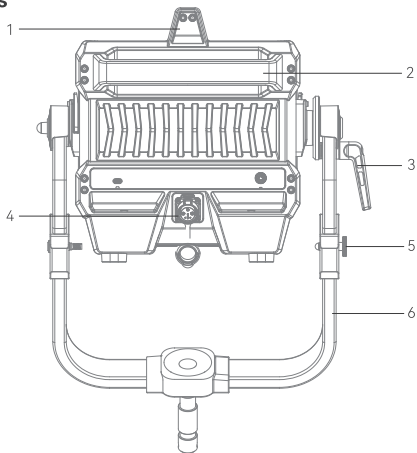

1. Handle 1
2. Handle 2
3. Direction Adjustment H handle
4. DC Input Port
5. Lanyard Attachment
6. Yoke
7. Mount Locking Pusher
8. Godox G-Mount
9. Quick Install Device

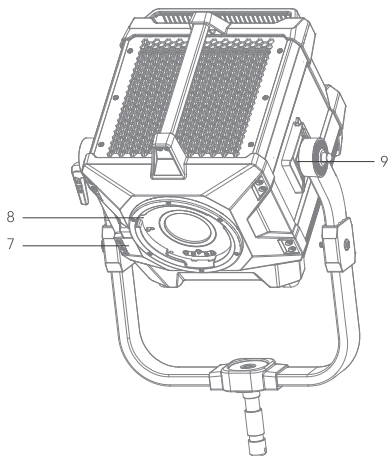

Controller

1. Antenna Port
2. Remove Controller Port
3. DC Output Port
4. PRESET Button
5. LOCK Button
6. MENU Button
7. MODE Button
8. Adjust Dial
9. Wireless CRMX Indicator
10. Power Switch
11. Display
12. DMX OUT Port
13. DMX IN Port
14. AC Input Port
15. Ethernet Port

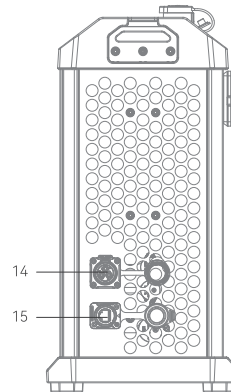
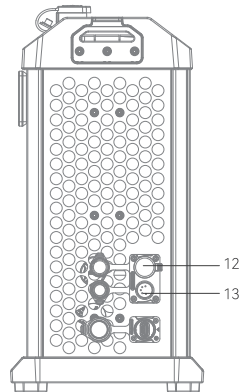
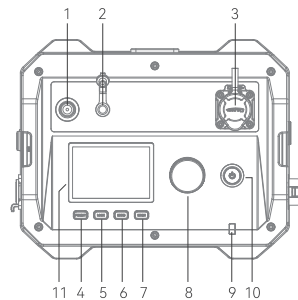

What's Inside MG2400Bi

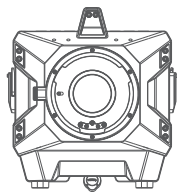

Light Body × 1

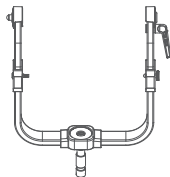

Yoke × 1

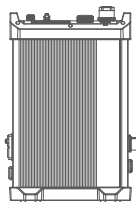

Controller × 1



Antenna × 1

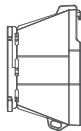

Reflector × 1



Pipe Clamp × 1



Light Protection
Cover × 1



Safety Wire × 1

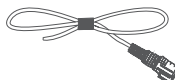

Main Cable × 1



DC Cable × 1



Tying Rope × 1



DMX Practical
Table × 1



Instruction
Manual × 1

What's Inside MG2400Bi K1

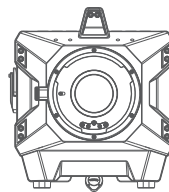

Light Body × 1

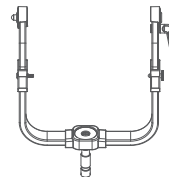

Yoke × 1

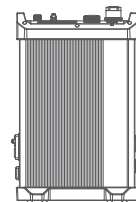

Controller × 1



Antenna × 1

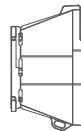

Reflector × 1



Pipe Clamp × 1



Light Protection
Cover × 1



Safety Wire × 1

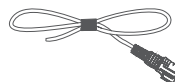

Main Cable × 1



DC Cable × 1



Tying Rope × 1



DMX Practical
Table × 1



Instruction
Manual × 1



Light Body Soft
Case SC18 × 1



Accessory Soft
Case SC19 × 1

What's Inside MG2400Bi K2

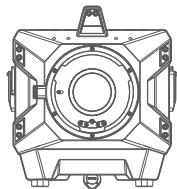

Light Body × 1

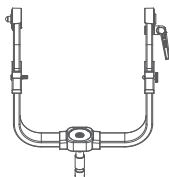

Yoke × 1

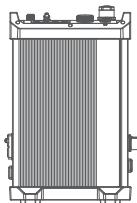

Controller × 1



Antenna × 1

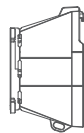

Reflector × 1



Pipe Clamp × 1



Light Protection
Cover × 1



Safety Wire × 1

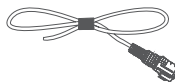

Main Cable × 1



DC Cable × 1



Tying Rope × 1



DMX Practical
Table × 1



Instruction
Manual × 1



Flight Case × 1

Note: Due to continuous updates and upgrades of the products, there may be differences between the actual products and the pictures. Therefore, the pictures are for reference only, products to prevail in kind.

Optional Accessories

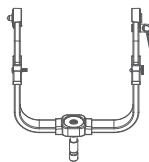

Yoke G2400BY01

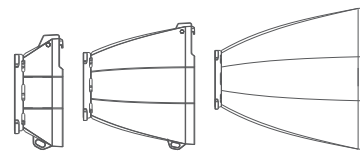

Reflector Kit GRK



Fresnel Lens GF14

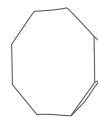

Octa G03

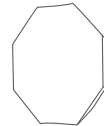

Octa G04

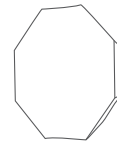

Octa G05



Parabolic
Softbox GP3



Parabolic
Softbox GP4



Parabolic
Softbox GP5

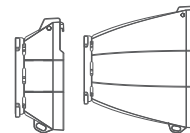

Reflector Kit GRK2

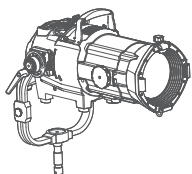

Projection GP19K

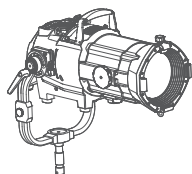

Projection GP26K

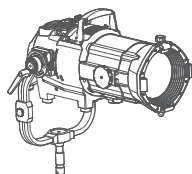

Projection GP36K



Soft Case SC18



Soft Case SC19

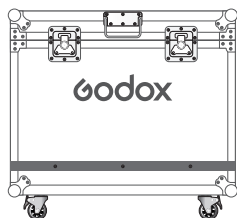

Flight Case FC05

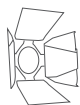

Barndoor GR45B



Barndoor GR30B

Installation and Disassembly

1. Installing the Yoke

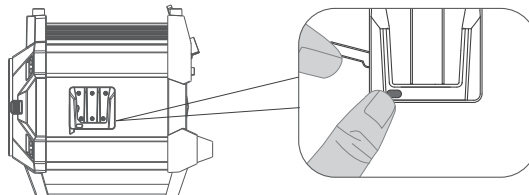

1.1 Place the light on a flat surface with the heat dissipation side upward.

1.2 Press down the quick install device button and remove the wrench.

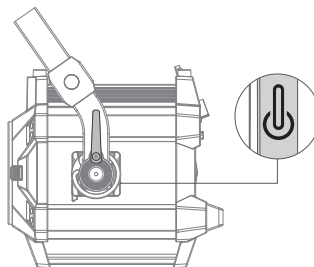

1.3 Align both ends of the yoke with the quick install device, lock the wrenches on both sides, and then the "click" indicates successful installation.

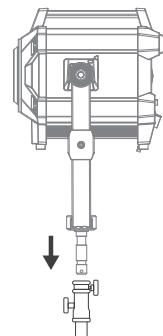

1.4 Install the light on the roller stand and lock the fixing knob on the roller stand.

Note: The roller stand is sold separately.

⚠ Please be careful when installing the light as it is quite heavy.

2. Disassembling the Yoke

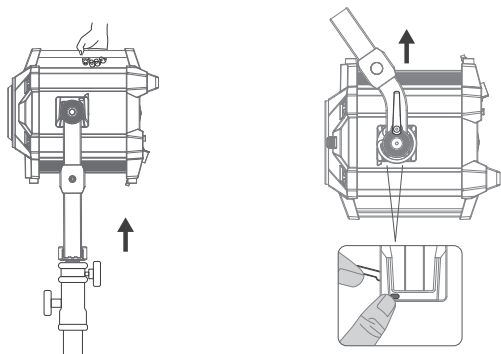

2.1 Hold the handle of the light and remove it from the roller stand then place it on a flat surface.

2.2 Press and hold the quick install device button and release the wrench to remove the yoke.

3. Installing/Disassembling the Light Protection Cover

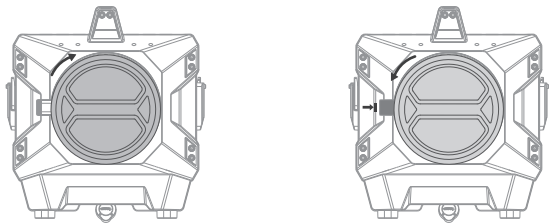

3.1 Align the light protection cover with the mount and rotate clockwise to install.

3.2 Press and hold the mount locking pusher and rotate counterclockwise to remove the light protection cover.

4. Installing/Disassembling the Reflector

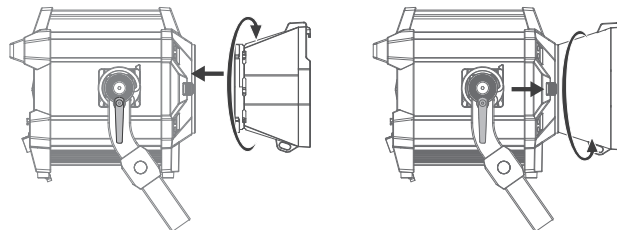

4.1 Align the reflector with the mount, insert and then rotate clockwise to install.

Note: Make sure to align the reflector with the mount of the lamp head.

4.2 Press and hold the mount locking pusher and rotate counterclockwise to remove the light protection cover.

5. Installing the Controller on the Light Stand

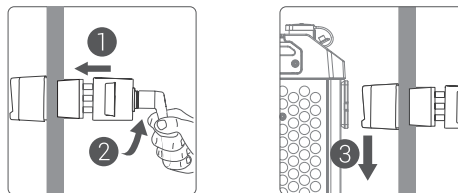

5.1 Loosen the handle of pipe clamp and insert the light stand pole, rotate the handle clockwise to lock the mounting device, then align the quick install device with the slot of mounting device and insert it.

6. AC Power Cord Connection Instructions

Wire 1 (yellow) is the ground wire, wire 2 (black) is the neutral wire, while wire 3 (red) is the live wire. Please ensure proper connection by matching the corresponding wires to the appropriate terminals on the plug before use.

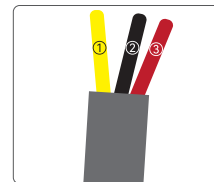

7. Connect to DMX 512 Controller

7.1 Wireless DMX Connection

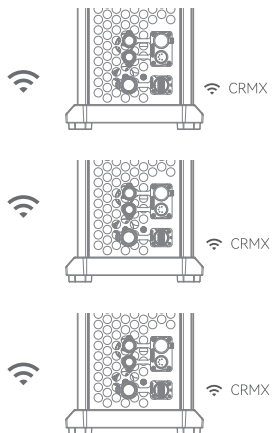
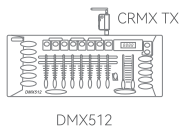

7.2 Wired DMX Connection

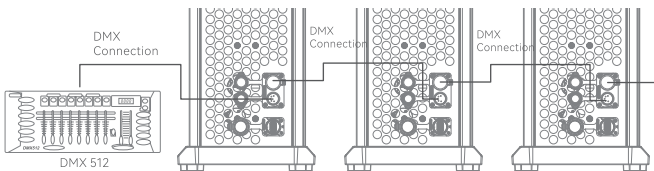

Note: The DMX cable is sold separately.

8. Connect to Ethernet

Connection 1

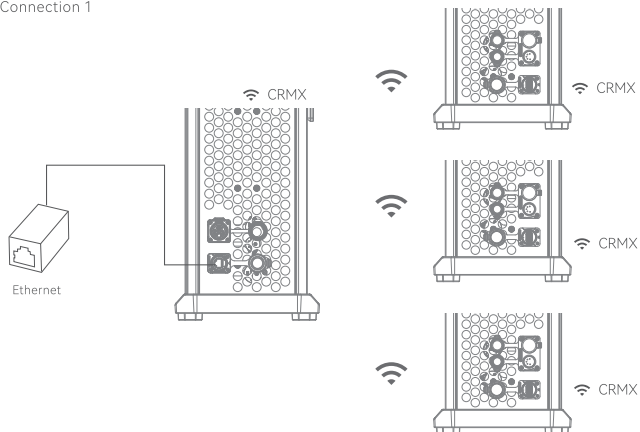

Connection 2

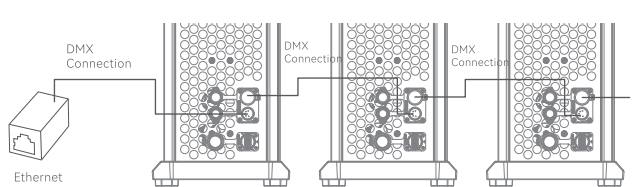

Power Supply

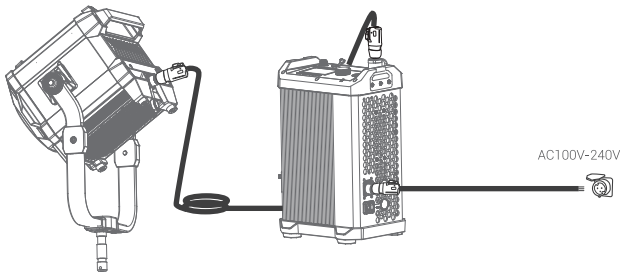

Note: Do not plug or unplug the power cord or connecting cable when the power is turned on, otherwise injuries may occur.

Power On/Off

Connect the device to the power source and briefly press the power switch button on the controller to turn it on or off.

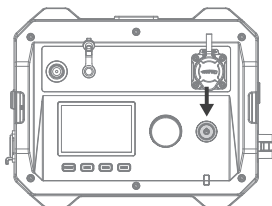

CCT Mode

Briefly press the MODE button to switch to CCT mode. Briefly press the adjust dial to switch between the brightness setting interface and color temperature setting interface.

In the brightness setting interface, turn the adjust dial to adjust the brightness ratio from 0% to 100%.

Turning the adjust dial clockwise once will increase the value by 0.1 unit, while turning it counterclockwise once will decrease the value by 0.1 unit. Quick adjustment is also available during rapid rotation.

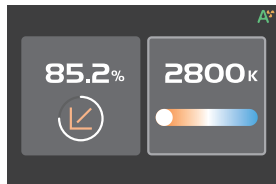

In the color temperature setting interface, turn the adjust dial to adjust the color temperature from 2800K to 6500K.

Turning the adjust dial clockwise once will increase the value by 100 units, while turning it counterclockwise once will decrease the value by 100 units.

FX Mode

Briefly press the MODE button to switch to FX mode. Turn the adjust dial to switch among the following 11 effects: flash, lightning, cloudy, broken bulb, TV, candle, fire, firework, explosion, welding, SOS.

Select the desired lighting effect and briefly press the adjust dial to enter the effect setting interface.

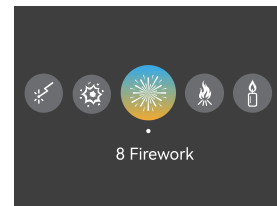

1. Flash Effect

In the flash effect setting interface, turn the adjust dial to select options among switch, dim, CCT, auto, manual, speed, mode, etc. Briefly press the adjust dial to select the desired option then turn the dial to adjust the options (except for the auto and manual options). Finally, continuously press the adjust dial/briefly press the MODE button to return to the previous menu.

Switch: Turn on/off the effect

Dim: 0%-100%

CCT: 2800K-6500K

Speed: 1-100

Mode: Camera Flash/Flash Bulb

Note: If manual is selected, the flash effect can be triggered once by briefly pressing the adjust dial.

2. Lightning Effect

In the lightning effect setting interface, turn the adjust dial to select options among switch, dim, CCT, auto, manual, times, frequency, etc. Briefly press the adjust dial to select the desired option then turn the dial to adjust the options (except for the auto and manual options). Finally, continuously press the adjust dial/briefly press the MODE button to return to the previous menu.

Switch: Turn on/off the effect

Dim: 0%-100%

CCT: 2800K-6500K

Times: Random/1-10

Frequency: Random /2-20

Note: If manual is selected, the lightning effect can be triggered once by briefly pressing the adjust dial.

3. Cloudy Effect

In the cloudy effect setting interface, turn the adjust dial to select options among switch, dim, ratio, speed, etc. Briefly press the adjust dial to select the desired option then turn the dial to adjust the options. Finally, continuously press the adjust dial/briefly press the MODE button to return to the previous menu.

Switch: Turn on/off the effect
Dim: 0%-100%
Ratio: 10%-90%
Speed: Random/1-100

4. Broken Bulb Effect

In the broken bulb effect setting interface, turn the adjust dial to select options among switch, dim, CCT, speed, etc. Briefly press the adjust dial to select the desired option then turn the dial to adjust the options. Finally, continuously press the adjust dial/briefly press the MODE button to return to the previous menu.

Switch: Turn on/off the effect
Dim: 0%-100%
CCT: 2800K-6500K
Speed: 1-100

5. TV Effect

In the TV effect setting interface, turn the adjust dial to select options among switch, dim, speed, etc. Briefly press the adjust dial to select the desired option then turn the dial to adjust the options. Finally, continuously press the adjust dial/briefly press the MODE button to return to the previous menu.

Switch: Turn on/off the effect
Dim: 0%-100%
Speed: 1-100

6. Candle Effect

In the candle effect setting interface, turn the adjust dial to select options among switch, dim, speed, etc. Briefly press the dial to select the desired option then turn the adjust dial to adjust the options. Finally, continuously press the adjust dial/briefly press the MODE button to return to the previous menu.

Switch: Turn on/off the effect
Dim: 0%-100%
Speed: 1-100

7. Fire Effect

In the fire effect setting interface, turn the adjust dial to select options among switch, dim, speed, etc. Briefly press the adjust dial to select the desired option then turn the dial to adjust the options. Finally, continuously press the adjust dial/briefly press the MODE button to return to the previous menu.

Switch: Turn on/off the effect
Dim: 0%-100%
Speed: 1-100

8. Firework Effect

In the firework effect setting interface, turn the adjust dial to select options among switch, dim, speed, embers, etc. Briefly press the adjust dial to select the desired option then turn the dial to adjust the options. Finally, continuously press the adjust dial/briefly press the MODE button to return to the previous menu.

Switch: Turn on/off the effect
Dim: 0%-100%
Speed: 1-100
Embers: 01-100

9. Explosion Effect

In the explosion effect setting interface, turn the adjust dial to select options among switch, dim, CCT, auto, manual, speed, embers, etc. Briefly press the adjust dial to select the desired option then turn the dial to adjust the options (except for the auto and manual options). Finally, continuously press the adjust dial/briefly press the MODE button to return to the previous menu.

Switch: Turn on/off the effect
Dim: 0%-100%
CCT: 2800K-6500K
Speed: 1-100
Embers: 1-100

Note: If manual is selected, the explosion effect can be triggered once by briefly pressing the adjust dial.

10. Welding Effect

In the welding effect setting interface, turn the adjust dial to select options among switch, dim, CCT, speed, etc. Briefly press the adjust dial to select the desired option then turn the dial to adjust the options. Finally, continuously press the adjust dial/briefly press the MODE button to return to the previous menu.

Switch: Turn on/off the effect
Dim: 0%-100%
CCT: 2800K-6500K
Speed: 1-100

11. SOS Effect SOS

In the SOS effect setting interface, turn the adjust dial to select options among switch, dim, CCT, etc. Briefly press the adjust dial to select the desired option then turn the dial to adjust the options. Finally, continuously press the adjust dial/briefly press the MODE button to return to the previous menu.

Switch: Turn on/off the effect
 Dim: 0%-100%
 CCT: 2800K-6500K

Note: The default dimming curve in FX mode is linear.

Menu Settings

Briefly press the MENU button to enter menu settings, turn the adjust dial to select among the following options: DMX, CRMX, Bluetooth, Network settings, Art-Net & sACN, optics recognition, power limit, dimming curves, fan, display, language, version & upgrade, factory reset, fixture info.

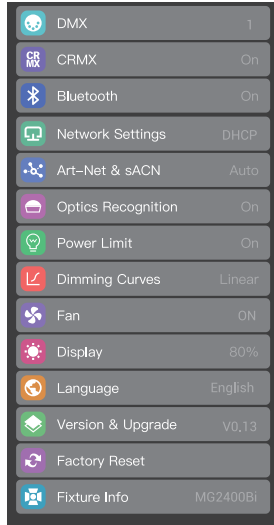

1. DMX

Briefly press the adjust dial to enter DMX setting interface. Turn the adjust dial to select options among address, DMX mode, RDM state, DMX lost, termination, extend DMX channels. Briefly press the adjust dial to select the desired option then turn it to adjust settings. Finally, briefly press the adjust dial to exit the current setting, briefly press the MENU button to return to the previous menu.

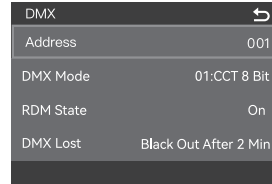

Interface when connected to DMX

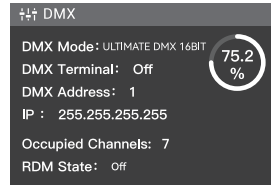

Interface when connected to CRMX

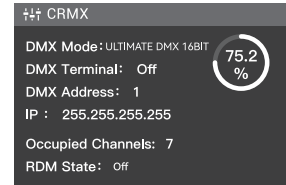

Level 1 Option	Level 2 Option	Description
Address	1-512	Initial address
DMX Mode	01:CCT 8 bit	CCT Mode in 8 bit
	02:FX 8 bit	FX Mode in 8 bit
	03:CCT 16 bit	CCT Mode in 16 bit
	04:FX 16 bit	FX Mode in 16 bit
	05:ULTIMATE DMX 8 bit	DMX Mode in 8 bit
	06:ULTIMATE DMX 16 bit	DMX Mode in 16 bit
RDM State	On	Turn on RDM
	Off	Turn off RDM
DMX Lost	Hold Last Command	After the DMX control signal is lost, continue to use the last received DMX control signal until power down or a valid DMX control signal is received again.
	Black Out	The light is off immediately.
	Black Out After 2 Min	After the DMX control signal is lost, continue to use the last received DMX control signal for 2 minutes then black out. Note: If a valid DMX control signal is received within 2 minutes, then use the new DMX control signal.
Termination	On	Turn on DMX terminal
	Off	Turn off DMX terminal
Extend DMX Channels	On	Turn on extend DMX channels
	Off	Turn off extend DMX channels

Note: Please refer to the DMX Practical Table to control the device by DMX/RDM. The electronic version can be downloaded from the official website <https://www.godox.com>.

2. CRMX

Briefly press the adjust dial to enter CRMX setting interface. Turn the adjust dial to select options between switch and mode. Briefly press the adjust dial to select the desired option then turn it to adjust settings. Finally, briefly press the adjust dial to exit the current setting, briefly press the MENU button to return to the previous menu.

Note: Before selecting the transmit mode/receive mode, perform a reset first.

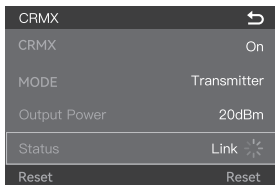

Transmitter mode in CRMX

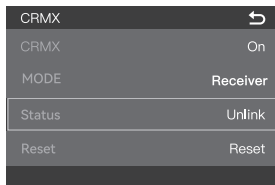

Receiver mode in CRMX

Level 1 Option	Level 2 Option	Description
CRMX	On	Turn on CRMX
	Off	Turn off CRMX
Mode	Transmitter	Transmitter mode
	Receiver	Receiver mode
Output Power	5dBm	Output power value = 5dBm (only adjustable in transmitter mode)
	11dBm	Output power value = 11dBm (only adjustable in transmitter mode)
	16dBm	Output power value = 16dBm (only adjustable in transmitter mode)
	20dBm	Output power value = 20dBm (only adjustable in transmitter mode)
Status	Link	To enter linked status (only adjustable in transmitter mode)
	Linking	Linking (only adjustable in transmitter mode)

3. Bluetooth

Briefly press the adjust dial to enter Bluetooth setting interface. Turn the adjust dial to select options between switch and reset. Briefly press the adjust dial to select the desired option then turn the dial to adjust settings. Finally, briefly press the MENU button to return to the previous menu.

Scan the QR code to download the "Godox Light" smartphone app version 3.0 or above (can be used in Android and iOS).

Note: The app can be used directly on the firstly installed device (smartphone or iPad). When change to other mobile device (smartphone or iPad), the light shall be reset before the normal connection of the app.



4. Network Settings

Briefly press the adjust dial to enter network settings interface. Turn and briefly press the adjust dial to select network mode, then turn the dial to select among DHCP, Art-Net 2.x, Art-Net 10.x and manual. Finally, briefly press the MENU button to return to the previous menu.

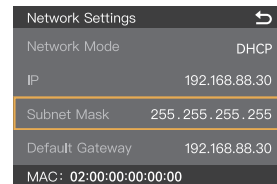

Godox KNOWLED App

Level 1 Option	Level 2 Option	Description
Network Mode	DHCP	DHCP mode
	Art-Net 2.x	To use 2.B.C.D network
	Art-Net 10.x	To use 10.B.C.D network
	Manual	Set the network IP, subnet mask, and default gateway manually.
IP	AAA.BBB.CCC.DDD	The ID address is assigned by DHCP in DHCP mode. The ID address is 2.B.C.D in Art-Net 2.x mode. The ID address is 10.B.C.D in Art-Net 10.x mode. In manual mode: AAA = 0-255 BBB = 0-255 CCC = 0-255 DDD = 0-255
Subnet Mask	255.BBB.CCC.DDD	The subnet mask is 255.BBB.CCC.DDD and can not be adjusted by menu settings in DHCP/Art-Net 2.x/Art-Net 10.x mode. In manual mode: AAA = 0-255 BBB = 0-255 CCC = 0-255 DDD = 0-255
Default Gateway	AAA.BBB.CCC.DDD	The default gateway is assigned by DHCP in DHCP mode. The default gateway is 2.B.C.D in Art-Net 2.x mode. The default gateway is 10.B.C.D in Art-Net 10.x mode. In manual mode: AAA = 0-255 BBB = 0-255 CCC = 0-255 DDD = 0-255

5. Art-Net & sACN

Briefly press the adjust dial to enter Art-Net & sACN setting interface. Turn and briefly press the adjust dial to select options among auto, Art-Net, sACN and off, then other level 2 options are available to adjust. Finally, briefly press the MENU button to return to the previous menu.

Art-Net & sACN	
Art-Net&sACN	Auto
Art-Net Net	101
Art-Net Sub-Net	12
Art-Net Port	11

Level 1 Option	Level 2 Option	Description
Art-Net&sACN	Auto/Art-Net/sACN/Off	Auto: Art-Net & sACN two protocols are accepted. Art-Net: Only Art-Net protocol. sACN: Only sACN protocol. Off: No network protocols are accepted.
Art-Net Net	0-127	Art-Net network
Art-Net Sub-Net	0-15	Choose Art-Net subnet in Art-Net network.
Art-Net Port	0-15	Art-Net port
Art-Net Universe	0...32767	Art-Net universe
sACN Universe	1...63999	sACN universe

6. Optics Recognition

Briefly press the adjust dial to enter optics recognition setting interface. Turn and briefly press the adjust dial to turn the function on or off. Finally, briefly press the MENU button to return to the previous menu.

Note: The light will not be lightened if the optics is not correctly installed even optics recognition function is turned on.

Optics Recognition	
Optics Recognition	On
Optics Recognition failed	

7. Power Limit

Briefly press the adjust dial to enter power limit setting interface. Rotate and briefly press the adjust dial to turn the function on or off. Finally, briefly press the MENU button to return to the previous menu.

Max. limit:10%-100%

Note: If the power supply environment is unable to meet the requirements for powering on, you can activate this function while the device is in the powered-off state. Simultaneously press the Preset button and MODE button, and the device will automatically enter the Power Limit mode upon startup (default power limitation is set to 50%).

Power Limit	
Power Limit	On
Maximum Limit	80%

8. Dimming Curves

Briefly press the adjust dial to enter dimming curves setting interface. Rotate and briefly press the adjust dial to choose among linear, S-curve, exponential and logarithmic. Finally, briefly press the adjust dial/MENU button to return to the previous menu.

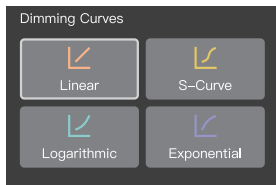

9. Fan

Briefly press the adjust dial to enter fan setting interface. Rotate and briefly press the adjust dial to choose among mute, auto, medium, and high. Finally, briefly press the adjust dial/MENU button to return to the previous menu.

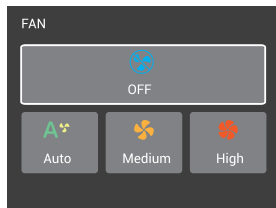

10. Display

Briefly press the adjust dial to enter display setting interface. Rotate and briefly press the adjust dial to adjust display brightness from 10% to 100%. Finally, briefly press the MENU button to return to the previous menu.

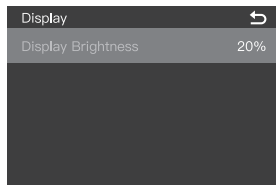

11. Language

Briefly press the adjust dial to enter language setting interface. Rotate and briefly press the adjust dial to select between Simplified Chinese and English. Finally, briefly press the MENU button to return to the previous menu.



12. Version & Upgrade

Briefly press the adjust dial to enter version & upgrade setting interface to check the firmware version of lamp head & controller and upgrade instruction. Then, short press the MENU button to return to the previous menu.



13. Factory Reset

To access the factory reset interface, briefly press the adjust dial. Rotate the adjust dial to select "Yes" or "No," then briefly press the adjust dial to complete the setting. Once you have confirmed the factory reset, the light fixture will restart, and the interface will automatically display options for Chinese and English. Rotate the dial to select an option and then press the dial to confirm the setting. At this point, the brightness value of the light will automatically be set to 100% and the interface will return to CCT mode interface.

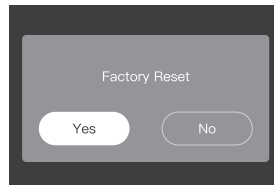

14. Fixture Info

Briefly press the adjust dial to enter fixture info setting interface to check model, UID NO., firmware version of lamp head and controller, light head temp., lamp maintenance time reminder, certification etc. Then, briefly press the MENU button to return to the previous menu.

When the lamp head displays a remaining maintenance time of 0 hours, it is recommended for the customer to clean the glass or other parts of the lamp head. We suggest using a dry or soft cloth to wipe away any dirt or debris on the equipment. Once the maintenance is complete, if you choose to reset, the lamp head maintenance time will start counting again.

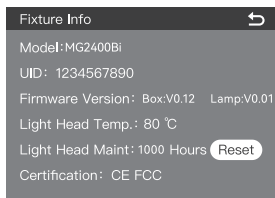

Lock Setting

Briefly press the LOCK button, the panel is locked when <  > is displayed on the panel, briefly press again to unlock.

Note: The locking function only works on the controller panel, other operations are still available.

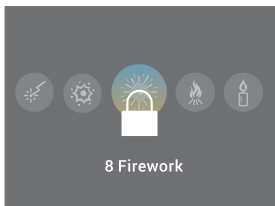

Preset Setting

Briefly press the PRESET button to enter preset effects interface. Rotate and briefly press the adjust dial to choose and enter preset effects 1-20, then briefly press to select save or cancel. Then, briefly press the adjust dial to return to the previous menu and briefly press the PRESET button to exit.

Apply: Apply this set of preset lighting effects.

Save: Save the current lighting effect of the light fixture.

Cancel: Return to the previous interface.

Note: If light effect data has been previously saved, there will be an additional option.

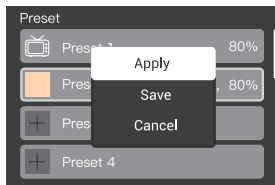

Software Upgrade

1. Firmware version of controller

1.1 Download the new firmware to the U disk from official website (<https://www.godox.com.cn/-firmware-continuous-light>).

1.2 Turn off the device. Insert the U disk with new firmware into the USB Type-A port.

1.3 Turn on the device, and MG2400Bi controller will automatically enter the upgrading interface.

1.4 It will return to main interface after completion.

2. Firmware version of lamp head

2.1 Download the new firmware to the U disk from official website (<https://www.godox.com.cn/-firmware-continuous-light>).

2.2 Turn off the device. Insert the U disk with new firmware into the USB Type-C port.

2.3 Turn on the device, and MG2400Bi lamp head will automatically enter the upgrading interface.

2.4 It will return to main interface after completion.

Notes:

1. New firmware must be downloaded from the official website, and keep only one BIN file in the root directory of the USB disk.

2. The USB Type-A port can only support output voltage and current of 5V/1.5A. Do not connect to over-rated USB device.

Version&Upgrade

Insert The U Disk With New Firmware After Power Off, Then Reboot To Upgrade The Device.

Box:0.13 Lamp:V0.03

Maintenance

This product, except consumables, is supported with a one-year warranty.

Unauthorized service will void the warranty.

Maintenance of the light must be performed by our authorized maintenance department which can provide original accessories.

If the product had failures or become wet, do not use it until it is repaired by professionals.

Shut down the device immediately should abnormal operation be detected.

Photometric Data

CCT	Testing Condition	Illuminance Unit	3m	5m	7m	9m	10m
2800K	Bare Light	lux	≈8810	≈3540	≈2120	≈1480	≈1250
		fc	≈818	≈329	≈197	≈137	≈116
3200K		lux	≈9700	≈3950	≈2360	≈1640	≈1380
		fc	≈901	≈367	≈220	≈152	≈128
4300K		lux	≈11600	≈4740	≈2840	≈1920	≈1650
		fc	≈1080	≈440	≈264	≈179	≈153
5600K		lux	≈12000	≈4890	≈2900	≈1970	≈1700
		fc	≈1120	≈454	≈269	≈183	≈158
6500K		lux	≈11300	≈4650	≈2730	≈1870	≈1600
		fc	≈1050	≈432	≈254	≈174	≈149

CCT	Testing Condition	Illuminance Unit	3m	5m	7m	9m	10m
2800K	With Reflector (45°)	lux	≈32200	≈11700	≈6240	≈4000	≈3380
		fc	≈2990	≈1090	≈580	≈372	≈314
3200K		lux	≈35900	≈13000	≈6900	≈4450	≈3740
		fc	≈3340	≈1200	≈641	≈413	≈348
4300K		lux	≈43200	≈15700	≈8340	≈5370	≈4490
		fc	≈4020	≈1460	≈775	≈499	≈417
5600K		lux	≈44600	≈16200	≈8590	≈5520	≈4650
		fc	≈4140	≈1500	≈798	≈513	≈432
6500K		lux	≈42100	≈15300	≈8110	≈5260	≈4400
		fc	≈3910	≈1420	≈753	≈489	≈408

The above data is not absolute values but rather average values. All tests were conducted with the light at 100% brightness.

Technical Data

Model	MG2400Bi
Power Supply	100V-240V~50/60Hz 30A(Max.)
Max. Power	≈2900W
CCT	2800-6500K
Brightness Range	0%-100%
Dimming Curves	linear, S-curve, exponential, logarithmic
FX Modes	11
CRI	Average96
TLCI	Average96
Waterproof Grade of Light Body/Controller	IP54
Controlling Methods	DMX 512 Control, support RDM protocol/LumenRadioCRMX/Bluetooth App Control/Ethernet (support Art-Net & sACN protocol)/Remove Controller/Light Body Control (Remove Controller RC11 is sold separately)
Bluetooth Controlling Distance	Max. 100m
USB Type-A Port	Firmware Upgrade/5V≈ 1.5A Power Supply
Dimension (Yoke and reflector are not included in the light body)	Light Body: 16.10"×15.16"×14.02" Controller: 11.02"×16.54"×8.27"
Netweight	Light Body (Yoke and reflector not included) : 20kg Controller: 13kg

Specifications and data may subject to changes without notice.

FCC Statement

This device complies with part 15 of the FCC Rules. Operation is subject to the following two conditions:

- (1) This device may not cause harmful interference, and
- (2) this device must accept any interference received, including interference that may cause undesired operation.

Any Changes or modifications not expressly approved by the party responsible for compliance could void the user's authority to operate the equipment.

Note: This equipment has been tested and found to comply with the limits for a Class B digital device, pursuant to part 15 of the FCC Rules. These limits are designed to provide reasonable protection against harmful interference in a residential installation. This equipment generates uses and can radiate radio frequency energy and, if not installed and used in accordance with the instructions, may cause harmful interference to radio communications. However, there is no guarantee that interference will not occur in a particular installation. If this equipment does cause harmful interference to radio or television reception, which can be determined by turning the equipment off and on, the user is encouraged to try to correct the interference by one or more of the following measures:

- Reorient or relocate the receiving antenna.
- Increase the separation between the equipment and receiver.
- Connect the equipment into an outlet on a circuit different from that to which the receiver is connected.
- Consult the dealer or an experienced radio/TV technician for help.

The device has been evaluated to meet general RF exposure requirement.

The device can be used in portable exposure condition without restriction.

Warning

Operating frequency: 2402MHz – 2480MHz (BT)

Maximum EIRP Power: 5dBm

Declaration of Conformity

GODOX Photo Equipment Co.,Ltd. hereby declares that this equipment are in compliance with the essential requirements and other relevant provisions of Directive 2014/53/EU. In accordance with Article 10(2) and Article 10(10), this product is allowed to be used in all EU member states. For more information of DoC, Please click this web link:

<https://www.godox.com/eu-declaration-of-conformity/>

The device complies with RF specifications when the device used at 0mm from your body.

产品保修

尊敬的用户, 本保修卡是申请保修服务的重要凭证, 请您配合销售商填写并妥善保管, 谢谢!

产品信息	型号	产品条码
用户信息	姓名	联系电话
	通信地址	
销售商信息	名称	
	联系电话	
	通信地址	
	销售日期	
备注		

注: 此表应由销售商盖章确认。

产品信息

本文件适用于相关《产品保修信息》(见后面说明)所列产品, 其他非属此范围的产品或部件(如促销品、赠品及其他出厂后附加的部件等)不在此保修承诺内。

保修期

产品及部件的相应保修期按相关的《产品保修信息》执行。保修期自产品首次购买日起算, 购买日以购买产品时保修卡登记日期为准。

如何获得保修服务

您可直接与产品销售商或授权服务机构联系, 也可拨打神牛产品售后服务电话, 与我们联系, 由我们的服务人员为您安排服务。申请保修时, 您应提供有效的保修卡作为保修凭证, 方可获得保修。如您不能提供有效的保修卡, 则在我们确认产品或部件属于保修范围的情况下, 也可以为您提供保修, 但这不作为我们的义务。

不适用保修的情况

如产品存在下列情况, 本文件项下的保证和服务将不适用: ①产品或部件超过相应保修期; ②错误或不适当使用、维护或保管导致的故障或损坏, 如: 不当搬运; 非按产品合理预期用途使用; 不当插拔外接设备; 跌落或外力挤压; 接触或暴露于不适当温度、溶剂、酸碱、水浸或潮湿环境; ③由非神牛授权机构或人员安装、修理、更改、添加或拆卸造成的故障或损坏; ④产品或部件原有识别信息被修改变更或删除; ⑤无有效保修卡; ⑥使用非法授权、非标准或非公开发行的软件造成的故障或损坏; ⑦因不可抗力或意外事件造成的故障或损坏; ⑧其他非因产品本身质量问题导致的故障或损坏。遇上述情况, 您应向相关责任方寻求解决, 神牛对此不承担任何责任。因非在保修期或保修范围内的部件、附件或软件导致产品不能正常使用的, 不是保修范围内的故障。产品使用过程中正常的脱色, 磨损和消耗, 不是保修范围内的故障。

产品保修和服务支持信息

产品的保修期和服务类型按以下《产品保修信息》执行:

产品类别	选件名称	保修期(月)	保修服务类型
部件	主机	12	客户送修
	电池	3	客户送修
	充电器等带电性能的部件。	12	客户送修
其他	如电源线、外壳、保护罩、锁紧装置、包装等。	无	无保修

神牛产品售后服务电话 0755-29609320-8062

Warranty

Dear customers, as this warranty card is an important certificate to apply for our maintenance service, please fill in the following form in coordination with the seller and safe-keep it. Thank you!

Product Information	Model	Product Code Number
Customer Information	Name	Contact Number
	Address	
Seller Information	Name	
	Contact Number	
	Address	
	Date of Sale	
Note		

Note: This form shall be sealed by the seller.

Applicable Products

The document applies to the products listed on the Product Maintenance Information (see below for further information). Other products or accessories (e.g. promotional items, giveaways and additional accessories attached, etc.) are not included in this warranty scope.

Warranty Period

The warranty period of products and accessories is implemented according to the relevant Product Maintenance Information. The warranty period is calculated from the day (purchase date) when the product is bought for the first time. And the purchase date is considered as the date registered on the warranty card when buying the product.

How to Get the Maintenance Service

If maintenance service is needed, you can directly contact the product distributor or authorized service institutions. You can also contact the Godox after-sale service call and we will offer you service. When applying for maintenance service, you should provide valid warranty card. If you cannot provide valid warranty card, we may offer you maintenance service once confirmed that the product or accessory is involved in the maintenance scope, but that shall not be considered as our obligation.

Inapplicable Cases

The guarantee and service offered by this document are not applicable in the following cases: ① The product or accessory has expired its warranty period; ② Breakage or damage caused by inappropriate usage, maintenance or preservation, such as improper packing, improper usage, improper plugging in/out external equipment, falling off or squeezing by external force, contacting or exposing to the improper temperature, solvent, acid, base, flooding and damp environments, etc; ③ Breakage or damage caused by non-authorized institution or staff in the process of installation, maintenance, alternation, addition and detachment; ④ The original identifying information of product or accessory is modified, alternated, or removed; ⑤ No valid warranty card; ⑥ Breakage or damage caused by using

illegally authorized, nonstandard or non-public released software; ⑦ Breakage or damage caused by force majeure or accident; ⑧ Breakage or damage that could not be attributed to the product itself. Once met these situations above, you should seek solutions from the related responsible parties and Godox assumes no responsibility. The damage caused by parts, accessories and software that beyond the warranty period or scope is not included in our maintenance scope. The normal discoloration, abrasion and consumption are not the breakage within the maintenance scope.

Maintenance and Service Support Information

The warranty period and service types of products are implemented according to the following Product Maintenance Information:

Product Type	Name	Maintenance Period(month)	Warranty Service Type
Parts	Circuit Board	12	Customer sends the product to designated site
	Battery	3	Customer sends the product to designated site
	Electrical parts e.g.battery charger, etc.	12	Customer sends the product to designated site
Other Items	Power cord, lamp cover,lockingdevice, package, etc.	No	Without warranty

Godox After-sale Service Call +86-755-29609320(8062)