

合格证  
QC PASS

# Godox

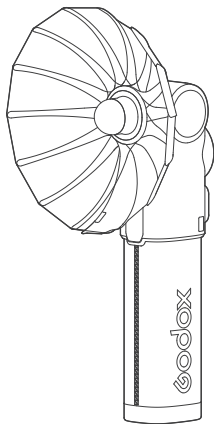

Wechat  
Official Account  
神牛微信公众号

#### 深圳市神牛摄影器材有限公司

地址: 深圳市宝安区福海街道塘尾社区耀川工业区厂房2栋  
电话: 0755-29609320(8062) 传真: 0755-25723423  
邮箱: godox@godox.com

#### GODOX Photo Equipment Co.,Ltd.

Add.: Building 2, Yaochuan Industrial Zone, Tangwei Community,  
Fuhai Street, Bao'an District, Shenzhen 518103, China  
Tel: +86-755-29609320(8062) Fax: +86-755-25723423  
E-mail: godox@godox.com

[www.godox.com](http://www.godox.com)

Made in China | 705-LUXMAS-02



## LUX MASTER

复古闪光灯  
Retro Camera Flash

使用手册  
Instruction Manual

## 重要安全提示

本产品属于专业摄影设备，需要专业人员操作使用。

使用时必须遵守以下基本安全预防措施：

使用前必须拆除产品上的所有运输保护材料和包装。

1. 使用本产品前，请仔细阅读并完全理解产品说明书，严格按照说明书中的安全提示操作。否则，可能导致死亡、严重伤害、产品损坏或其他财产损失的安全隐患。
2. 闪光灯工作时存在高电压，关机后设备内部电容仍将持续带电一段时间。
3. 本产品为专业灯具，儿童禁止使用。儿童接近时，成人必须密切监督，防止儿童碰撞灯具或私自使用灯具，造成人身伤害。
4. 本灯具并非普通灯具，不可用于普通照明，任何有过眼部损伤或眼部敏感的人群均应避免使用本灯具或直视本灯具。
5. 使用时必须小心，严禁接触如闪光灯管等高温部件，以避免烫伤。
6. 任何情况下均禁止将闪光灯直接对准人眼（特别是婴儿眼睛），否则短时间内可能导致视力损伤。如感到眼睛不适，应立即关闭灯具，停止使用并及时就医。
7. 闪光灯损坏时，应立即停止使用，及时联系制造商、服务代理商或合格维修人员更换，以防发生事故。
8. 严禁使用损坏的设备或配件，必须等待专业维修人员检查维修并确认设备正常后，才可继续使用。

9. 更换灯管、保护玻璃或保险丝前，必须断开电源或者拆下电池（如装有电池），确保灯具与电源完全断开。更换灯管前让其冷却10分钟，操作时需戴绝缘/或隔热手套。
10. 拔插头插头时必须关闭产品电源，插入插头时务必检查是否完全卡入。
11. 使用过程中，如果产品因跌落、挤压或强力冲击导致外壳破裂，应立即停止使用，避免接触内部电子部件而触电受伤。
12. 部分产品电源线较长，请合理放置，避免接触热源或绊倒他人。建议使用原装电源线。非原装造成的损坏不在保修范围内。
13. 进行清洁和维修前，请先从电源插座上拔出设备电源插头。不要拉扯电源线强行拔出，正确方法是用双手抓住插头端头拔出。
14. 本设备不防水，请保持干燥，不能浸入水或其他液体；应安装在通风干燥位置，避免在雨天、潮湿、多尘或过热环境中使用。不要在设备上方放置物品，或让液体流入内部，防止发生危险。
15. 未经授权，请不要自行拆卸本产品。产品若出现故障，必须由本公司或授权维修人员检查和维修。
16. 存放设备前，请确保设备已完全冷却，拔下电源线，放入设备包内或通风干燥位置。
17. 请勿将设备放置在酒精、汽油等易燃挥发性溶剂或气体如甲烷、乙烷等附近。
18. 本设备禁止在有爆炸危险的环境中使用或存放。
19. 运行期间和之后，设备灯头与用户和其他人员，以及热敏或可燃物品之间，距离必须始终保持至

少1米。

20. 严禁覆盖设备散热口！

21. 请勿使用未经本公司认可的配件，以免造成火灾、触电或人身伤害。

22. 清洁设备时，请用干燥软布轻轻擦拭，不可使用湿布，否则可能会损坏设备。

23. 本使用说明基于严格测试制定，设计和规格变更恕不另行通知。您可登录我们官方网站查看最新电子版使用说明，了解产品最新资讯。

24. 部分产品内置锂电池，必须使用专用充电器充电，并按正确操作说明，在规定电压和温度范围内使用。

25. 产品使用锂电池供电，这类锂离子电池使用寿命有限，会逐渐失去储能能力，这种能力下降不可逆。电池老化时，产品续航时间会减少。锂离子电池使用寿命预计2—3年。请定期检查电池情况，如果充电时间明显增加或续航时间明显减少，请考虑更换新电池。

26. 部分产品配备锂电池，其储存建议如下：储存前，将电池充放电至约50%电量；至少每6个月充电一次，至约50%电量；可拆卸电池应单独存放；储存温度在0°C至40°C范围内。

27. 产品使用锂电池供电，请注意以下事项：

- 不要拆卸、压碎或刺穿电池；
- 避免使电池触点短路；
- 不要在火中或水中处理电池；
- 不要将电池暴露在60°C以上高温下；
- 将电池放在儿童接触不到的位置；
- 防止电池遭受过度冲击或振动；

- 不要使用已损坏的电池；

- 如果电池出现泄漏，请避免接触泄漏液体；

- 如果眼睛接触电池液体，立即用水冲洗至少15分钟，抬起眼睑直到没有液体的迹象后及时就医。

28. 处理任何电池前，请确认并遵守当地相关法律法规。

29. 本设备整机的保修期为一年。消耗品（如电池）、适配器、电源线等配件不在保修范围内。

30. 私自维修将取消保修资格，需支付维修费用。

31. 不当操作导致故障不在保修范围。

# 目录

- 01 前言
- 01 警告
- 02 部件名称
- 03 开机/关机
- 03 四种模式下的屏显
- 04 展开闪光管/回缩闪光管
- 04 安装反光罩/拆卸反光罩
- 06 安装相机闪光灯支架FB01
- 07 标配物品
- 08 另购附件
- 08 触屏使用
  - 1.模式
  - 2.无线
  - 3.设置
- 15 按键与拨盘的使用
  - 1.模式
  - 2.无线
  - 3.设置
- 20 过热保护
- 20 其他保护
- 21 激活过热保护功能的连续闪光次数
- 21 高速同步模式下，激活过热保护功能的连续闪光次数
- 22 规格参数
- 23 故障排除指南
- 24 固件升级
- 24 神牛2.4G无线漏闪原因及解决办法
- 25 维修保养

## 前言

感谢您购买神牛产品。

神牛新品Lux Master复古闪光灯，主打内外兼修，复古的外在有着金属特质的凌厉感，反光罩的设计上采用中式折扇的原理，手动收展中实现极简收纳。

独特的造型配以内里强劲功率，1/1 M档提供GN25闪光指数；拥有四种闪光模式（TTL自动闪光、A档自动闪光、M档手动闪光、频闪闪光）；支持2.4G无线接收，可接受引闪器XPROII、X2T、X3远距离控制。

摒弃复杂，智取Lux Master。触屏的设计在指尖轻触间就实现功率增减、模式切换、S1/S2光控引闪以及屏幕调节等多样人性化设置。本品兼容佳能、尼康、富士、奥林巴斯、索尼、徕卡、宾得等各类相机。

## 警告

- ▲ 请注意，灯管属于易碎物品。不使用时，请将灯管按压推回并妥善收纳。
- ▲ 在正常使用的过程中，反光罩可能会出现一定程度的磨损，这是正常现象，不会影响产品的使用。

## 部件名称

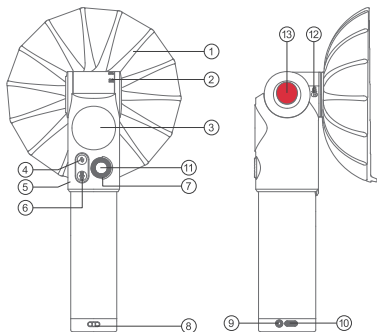

1. 金属伞形反光罩
2. 灯头旋转刻度
3. 智能触屏
4. 试闪按键/回电指示灯
5. 光控传感器
6. 开关/MENU按键
7. 调节拨盘
8. 挂绳孔
9. 同步孔
10. USB-C接口
11. SET按键
12. 卡口推制
13. 灯管释放键

## 开机/关机

开机：长按开关键<  >，屏幕出现Godox后紧接着出现解锁符号<  >，顺时针旋转拨盘或触屏顺时针画圈即可开机。

关机：长按开关/MENU键，屏幕熄灭即关机完毕。

## 四种模式下的屏显



M档手动闪光界面



频闪闪光界面



A档自动闪光界面



TTL自动闪光界面

## 展开闪光管/回缩闪光管

展开闪光管：短按灯管释放键，闪光管即可瞬间弹出。



回缩闪光管：按压闪光管向内缓推，听到嘀嗒一声即归位（安全起见操作此项时请戴手套）



注：闪光管回缩时，回电指示灯呈现常红色状态，此时闪光管无法闪光。

## 安装反光罩/拆卸反光罩

安装：将反光罩对齐卡口，顺时针旋转至听到“嘀嗒”一声，即安装到位。使用时将折叠反光罩顺时针舒展开，将两端扣起组成完整圆形。

金属伞形反光罩采用双端扣设计，方便快速切换至14叶或15叶叶构型，实现不同光线扩散效果，满足多样化变焦需求。

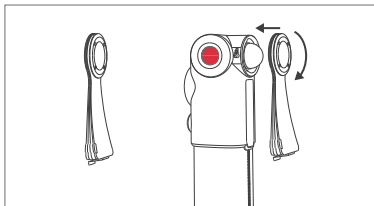

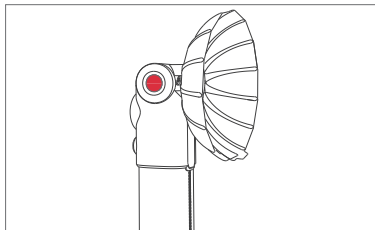

拆卸：将卡口推制往后推动的同时逆时针旋转反光罩，即拆卸完毕。

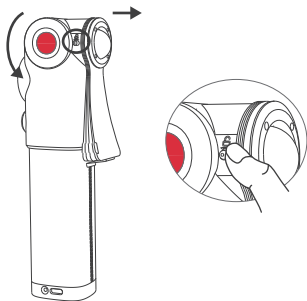

## 安装相机闪光灯支架FB01

将Lux Master底部的螺丝孔对准FB01支架上的螺丝，在下方将螺丝旋钮顺时针拧紧，另一侧以同样方式安装相机。

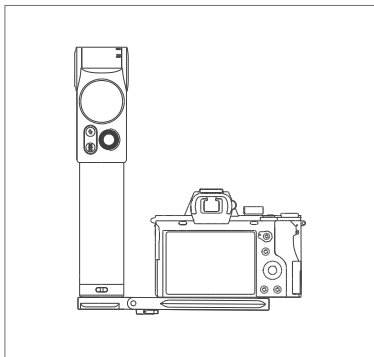
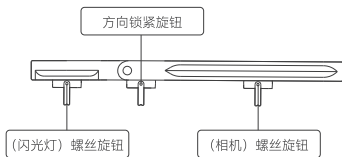

## 标配物品



灯体  
× 1



金属伞形  
反光罩LM-R27  
× 1

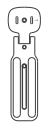

相机闪光灯  
支架FB01  
× 1



引闪线  
× 1



充电线  
× 1



收纳包  
× 1



灯管保护盖  
× 1



说明书  
× 1

## 另购附件



自动感应器AS-01  
× 1



反光罩LM-R28  
× 1



金属伞形反光罩  
LM-R27  
× 1

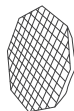

八角柔光箱  
LM-S25  
× 1



相机闪光灯支架  
FB01  
× 1

## 触屏使用

屏幕上的参数都可以通过触摸方式进行调节，开机后下滑屏幕来到菜单界面，往左滑动依次可见模式、无线、设置三项功能。





## 1.模式



点击进入模式设置，上下滑动可选Manual/Multi/Auto/TTL模式，选中其中一项后右滑返回上级，此时指示光标在下侧，表示可进一步调节该模式的各项参数。



进入参数调节界面后，轻触右上侧“模式显示区域”，可快速切换四种模式，免去返回上级菜单操作。



### 组别显示区域

轻触组别显示区域可见下列数据，通过上下滑动选择。上触<  >进行开关设置，下触<  >进行无线同步，设置完毕右滑返回。

频道 ( CH )	调节范围: 1- 32
组别 ( GR )	调节范围: A、B、C、D、E
识别号 ( ID )	调节范围: OFF、1- 99

### 调节Manual

轻触参数区域可调节功率，上下滑动可在1/256-1/1全功率或2.0-10全功率间选择，设置完毕右滑返回。



## 调节Multi

轻触参数区域，上下滑动可调节功率/次数/频率，设置完毕右滑返回。

不同功率档位下的最大频闪闪光次数

频率 \ 功率	1	2	3	4	5	6-7	8-9	10	11	12-14	15-19	20-50	60-99
1/4 (8.0)	7	6	5	4	4	3	3	2	2	2	2	2	2
1/8 (7.0)	14	14	12	10	8	6	5	4	4	4	4	4	4
1/16 (6.0)	30	30	30	20	20	20	10	8	8	8	8	8	8
1/32 (5.0)	60	60	60	50	50	40	30	20	20	20	18	16	12
1/64 (4.0)	90	90	90	80	80	70	60	50	40	40	35	30	20
1/128 (3.0)	90	90	90	90	90	90	80	70	70	60	50	40	40
1/256 (2.0)	90	90	90	90	90	90	80	70	70	60	50	40	40

## 调节Auto

轻触附件可见以下四种光效附件，上下滑动选择，设置完毕右滑返回。

注：在设置机内光效附件的时候请对应实际使用的光效附件，以确保闪光输出的匹配。



金属伞形  
反光罩



反光罩



反光罩 + 柔光球



八角柔光箱

轻触参数区域，上下滑动可调光圈与感光度，以下为A档自动闪光模式下的实用表。

1档	感光度	25	50	100	200	400	800	1600	
	光圈	1.4	2	2.8	4	5.6	8	11	
	使用范围	金属伞形反光罩				最远约 7.2米			
		反光罩				最远约 12米			
		反光罩 + 柔光球				最远约 4米			
八角柔光箱带柔光布				最远约 4.6米					
2档	感光度	25	50	100	200	400	800	1600	
	光圈	2	2.8	4	5.6	8	11	16	
	使用范围	金属伞形反光罩				最远约 5米			
		反光罩				最远约 8.5米			
		反光罩 + 柔光球				最远约 2.8米			
八角柔光箱带柔光布				最远约 3.2米					
3档	感光度	25	50	100	200	400	800	1600	
	光圈	2.8	4	5.6	8	11	16	22	
	使用范围	金属伞形反光罩				最远约 3.6米			
		反光罩				最远约 6.1米			
		反光罩 + 柔光球				最远约 2米			
八角柔光箱带柔光布				最远约 2.3米					

A模式仅供支持单触点的相机使用，需搭配自动感应器，此处以AS-01感应器为例子。

将AS-01感应器的热靴端插入相机热靴接口，另一头的PC线插入闪光灯同步孔，确认相机要使用的光圈和ISO后，调节闪光灯的光圈和ISO与相机保持一致。

## 调节TTL

TTL自动闪光模式仅支持从属使用，接受具有无线发射的闪光灯控制（主灯需另购。）

轻触组别显示区域，通过上下滑动选择。上触

<  >进行开关设置，下触<  >进行无线同步，设置完毕右滑返回。

## 2.无线

此处以X3系列引闪器为例子，当使用X3系列引闪器触发Lux Master闪光时，无线同步功能协助您快速设置双方的无线频道、识别号为一样号码。

通过上下滑动选择，上触<  >进行开关设置，下触<  >进行无线同步，设置完毕右滑返回。

操作：1.点击引闪器上的<无线同步>，2.点击复古闪光灯Lux Master<  >即可无线同步。



## 3.设置

点击进入自定义设置，点击对应图标可进入以下十项界面，上下滑动选择，设置完毕右滑返回。

图标	功能	选项	备注
	光控引闪	S1	支持在 M 手动闪光模式下使用, 它会与主闪光灯的第一次闪光同步触发闪光
		S2	支持在 M 手动闪光模式下使用, 它会与主闪光灯的第二次闪光同步触发闪光
	4 种光效附件选择	金属伞形反光罩	仅用于 Auto 模式
		反光罩	
		反光罩+柔光球	
		八角柔光箱	
		八角柔光箱	
	屏幕休眠	关	关闭屏幕休眠功能
		30 秒	超过 30 秒无人操作, 屏幕进入休眠
		1 分	超过 1 分钟无人操作, 屏幕进入休眠
		2 分	超过 2 分钟无人操作, 屏幕进入休眠

图标	功能	选项	备注
	自动关机	3 分	超过 3 分钟无人操作, 屏幕进入休眠
		4 分	超过 4 分钟无人操作, 屏幕进入休眠
		5 分	超过 5 分钟无人操作, 屏幕进入休眠
		关	关闭自动关机功能
	蜂鸣器	30 分	30 分钟后自动关机
		60 分	60 分钟后自动关机
		90 分	90 分钟后自动关机
	蜂鸣器	开/关	黄色: 蜂鸣器开启 灰色: 蜂鸣器关闭
	步进 (闪光档位显示方式)	1/256	机器闪光档位显示为 1/256-1/1。
		2.0	机器闪光档位显示为 2.0-10。
	屏幕亮度	无	亮度条 (上下滑动调节)
	语言	English	机器字体显示为英文
		简体中文	机器字体显示为简体中文
	重置设备	重置	恢复出厂设置
		取消	取消恢复出厂设置操作
	设备信息	无	此界面显示机器型号及其固件版本号

## 按键与拨盘的使用

### 1. 模式

#### Manual (M档手动闪光)

在M档手动闪光模式下，您可以在1/256-1/1全功率或2.0-10全功率间以0.1档为增量设置闪光输出。为获得正确的闪光曝光，请使用手持的闪光测光表确定所需的闪光输出。

1. 短按MENU键进入功能选择，旋转拨盘选择“模式”，短按SET按键旋转拨盘选中Manual模式。



2. 再次短按SET按键即可进入Manual界面，此时可以旋转拨盘调节M档手动闪光的功率档位。



#### S1 光控单元设置

在M手动闪光模式下，可以使用S1功能，闪光灯可作为副灯使用，创造多种照明效果，适用于手动闪光环境。它会与主闪光灯的第一次闪光同步触发闪光，效果与使用无线引闪器一致。

#### S2 光控单元设置

在M手动闪光模式下，可以使用S2功能，闪光灯可作为副灯使用，适用于TTL闪光环境；具有防预闪功能，使用带一次预闪功能的相机能用光控实现同步拍摄；它会与主闪光灯的第二次闪光同步触发闪光，即2次光控引闪。

注：只有在M档手动闪光模式下才支持S1/S2光控引闪。

#### Multi (频闪闪光)

使用频闪闪光，可以发出一系列快速的闪光，让您以拍摄出移动物体的多个图像，可以在1/256-1/4或2.0-8.0之间设置闪光输出。

您可以设置闪光频率(每秒的闪光次数，以Hz表示)、闪光次数和闪光输出。

1. 短按MENU键进入功能选择，旋转拨盘选择“模式”，短按SET按键旋转拨盘选中Multi模式。



2. 再次短按SET按键即可进入Multi界面，此时可以旋转拨盘调节频闪闪光的功率档位，短按SET按键可选闪光次数或闪光频率(Hz)，选中后旋转拨盘进行调节。

闪光次数：1-90，

闪光频率(Hz)：1-99。



## 计算快门速度

在频闪闪光过程中，到闪光停止为止快门应保持开启状态。使用下面的公式计算快门速度，然后用相机进行设置。

闪光次数/闪光频率 = 快门速度

举例，如果闪光次数是10，闪光频率是5Hz，快门速度则至少为2秒。

注：为防止闪光灯头过热并损坏，请勿执行连续10次以上的频闪闪光连拍。闪光10次后，请让闪光灯至少冷却15分钟。如果您试图执行连续10次以上的频闪闪光连拍，为防止闪光灯头过热，闪光可能自动停止。如果发生了这种情况，请让闪光灯至少冷却15分钟。

## Auto (A档自动闪光)

1. 短按MENU按键进入功能选择，旋转拨盘选择“模式”，短按SET按键旋转拨盘选中Auto模式。



2. 再次短按SET按键即可进入Auto界面，旋转拨盘可调光圈与感光度，此模式下参数区域的调节可参考触屏使用中列出的A档自动闪光模式实用表。



注：使用过长镜头可能会影响A模式光输出。

## TTL (TTL自动闪光)

此TTL自动闪光模式仅支持从属使用，接受具有无线发射的闪光灯控制（主灯需另购。）

1. 短按MENU键进入功能选择，旋转拨盘选择“模式”，短按SET按键旋转拨盘选中TTL模式。



2. 再次短按SET按键即可进入TTL界面。



注：只有无线开启状态，此模式才会显示。

## 高速同步闪光：

使用高速同步(FP闪光)，您可以在所有的快门速度下同步使用闪光灯。高速同步闪光在使用光圈优先对人像进行填充闪光时特别方便。

高速同步闪光仅支持从属使用，通过2.4G无线引闪器打开此功能，该模式仅支持在Manual模式和TTL模式闪光，您可以在1/64-1/1全功率或4.0-10全功率间以0.1档为增量设置闪光输出。

注意事项：使用高速同步，快门速度越高，有效的闪光范围就越小。

在高速同步模式下，无法设置频闪闪光。

连续高速同步闪光多次后，闪光灯热保护功能可能会被激活。

## 2. 无线

闪光灯Lux Master具备2.4G无线接收，可接收无线发射闪光灯信号。

1. 短按MENU键进入功能选择，旋转拨盘选择“无线”，短按SET按键进入无线设置。



2. 旋转拨盘可设置无线开关，CH、GR、ID及其具体选项参数，无线同步。



频道（CH）调节范围:1-32。

组别（GR）调节范围:A、B、C、D、E。

识别号（ID）调节范围:OFF、1-99。

## 3. 设置

闪光灯具备9种自定义设置。

短按MENU键进入功能选择，旋转拨盘选择“设置”，短按SET按键进入自定义设置。

旋转拨盘可在9项设置中来回选择，短按SET按键可进入其中一项进行设置，通过旋转拨盘调节，具体选项可对照触屏设置中的界面。

## 过热保护

- 为防止闪光灯头过热并损坏，系统做了热保护功能，当连续引闪多次后，内部的防过热功能可能会被激活，使充电时间变慢。如果发生这种现象，请让闪光灯冷却约10分钟，闪光灯便会恢复正常。
- 热保护启动后，显示屏下方出现 <  > 闪烁符号。



## 其他保护

为了保证设备安全的工作，系统时刻进行预防保护，以下提示符号供您参考。

LCD 显示	警示内容
E1	闪光灯回电系统出现问题，无法回电引闪，请重新开机，如无法解决请维修。
E3	闪光灯管两端电压过高，请维修。

## 激活过热保护功能的连续闪光次数

档位	连续闪光次数
1/1	50
1/2	75
1/4	90
1/8	150
1/16	200
1/32	260
1/64	480
1/128	1100
1/256	1100

## 高速同步模式下，激活过热保护功能的连续闪光次数

档位	连续闪光次数
1/1	45
1/2	55
1/4	75
1/8	80
1/16	80
1/32	80
1/64	80
1/128	80
1/256	80

注：高速同步需在引闪器（另购）中设置。

## 规格参数

型号	Lux Master
闪光指数 (1/1档位)	GN25 (ISO100, 以米为单位)
锂电池参数	DC7.2V, 2980mAh, 21.456Wh
输入参数	5V $\overline{\text{---}}$ 2A
充电时间	≈2h(5V/2A)
闪光灯色温	6200K±200K
M 档功率显示方式	1/1 -1/256(每档以+0.1档为增量) 或10-2.0(每档以+0.1档为增量)
A 档自动闪光	默认相机参数设置为 F2.8 ISO100
光控引闪	S1 光控同步引闪/S2 光控防预 闪引闪
2.4G 无线频道	1-32
2.4G 组别	A、B、C、D、E
2.4G 无线ID	OFF(关闭)、1-99
2.4G 无线传输距离	最远100m
同步方式	前帘同步、后帘同步、高速同步 (在另购引闪器中设置)
灯头旋转角度	0°-90°(四档, 每档以+30°为 增量)
工作环境温度	-10°C ~50°C
回电时间 (1/1档位)	≈1.8s
全功率闪光次数 (1/1档位)	≈460次
电池充电温度范围	0°C-45°C
同步触发	同步线
尺寸 (含展开反光罩)	≈140mm*260mm*99mm
净重 (含反光罩)	≈470g

规格和参数如有变更, 恕不另行通知。

## 故障排除指南

使用中遇到问题，请参考此故障排除指南

问题	可能原因	解决办法
闪光灯不闪光	引闪线没有连接好	请检查引闪线两端是否分别插入相机及其闪光灯同步孔
电源自动关闭	机器设置屏幕休眠	可按机身任意按键唤醒
无法开机	电池没电或电池已损坏	请及时充电或联系神牛售后，返厂维修
作为从属灯时不闪光	从属灯设置的闪光组别不正确；例如主控灯 B 组处于关闭状态，而从属灯闪光灯组设置为 B	正确设置从属灯的闪光组
	主控灯和从属灯设置的传输频道不一致	请将主控灯和从属灯传输频道设置成一致，例如主控灯频道为 01，从属灯频道也为 01
	从属灯不在主控灯的无线传输范围内	请将从属灯放置在主控灯的无线控制范围（主控灯引闪范围请看主控灯的使用手册）
	主控灯和从属灯过于靠近，无法正常进行传输	请设置主控灯的引闪距离（如何设置请看主控灯的使用手册）
设备卡死，操作按键或触摸没有反应	设备软件故障	请同时按下试闪按键和SET按键可强制关闭设备，然后重新开机查看是否正常。

注：指南中所提主控灯为客户的另购灯具，是指具备无线发射功能的闪光灯，该指南仅供参考，如无法解决您的问题，请及时联系神牛售后。

## 固件升级

1. 本产品USB接口为USB-C接口，请使用USB-C线（另购）。
2. 产品升级固件需要Godox G3程序软件支持，升级固件前请前往神牛官网<https://www.godox.com.cn> 下载安装“Godox G3固件升级软件”，再选择相应的固件文件。
3. 固件升级时可打开设置中的设备信息查看，此界面会显示升级选项。

操作：1. 点击升级，2. 点击是（进入升级）或点击否（取消升级），3. 升级中

注：请用Godox G3\_V1.1或以上版本的程序软件，由于产品进行固件升级，说明书请以最新电子版为准。



## 神牛2.4G无线漏闪原因及解决办法

1. 外部环境2.4G信号干扰(如无线基站、2.4Gwifi路由、蓝牙设备等)  
→请调节闪光灯的频道CH设置(建议+10) 找到无干扰的频道，或者在工作时关闭其他2.4G设备。



2. 请确认闪光灯是否已经回电或回电速度是否跟上连拍速度(闪光灯就绪指示灯已经亮起), 并且没有处于过热保护或者其他异常状态中。

→请下调闪光灯档位, 如是TTL模式下可以尝试改为M模式(TTL模式下需要预闪一次)。

3. 是否主控灯和从属灯距离太近(距离<0.5m)

→请设置主控灯引闪范围 (主控灯引闪范围请看主控灯的使用手册)

4. 是否闪光灯在低电状态

→请更换电池。

## 维修保养

闪光灯工作时, 如发现异常, 请立即关掉电源, 查明原因。

灯体应避免震动, 平时注意表面除尘。

灯体稍有发热为正常现象, 无特别需要时, 勿连续引闪。

闪光灯所有维修一概由本厂指定可供原厂配件的维修部负责。

1年保修, 消耗品如灯管等, 不在1年保修范围。

经发现, 擅自检修此闪光灯的, 将取消闪光灯保修, 维修需收取相关费用。

如有技术更改, 恕不另行通知。

## Important Safety Instructions

This product is a professional photographic equipment, to be operated by professional personnel only.

The following basic safety precautions must be followed when using this product:

All transport protective materials and packaging on the product must be removed before use.

1. Carefully read and fully understand the instruction manual before use and strictly follow the safety instructions. Failure to do so may result in death, serious injury, damage to the product, or other property damage.
2. High voltage exists when the flash is powered on. Internal capacitors will remain charged for some time after power off.
3. This product is a professional lighting fixture, children are prohibited from using it. Children must be closely supervised by adults when approaching the fixture, to prevent collisions with the fixture or unauthorized use that could cause personal injury.
4. This is not an ordinary lighting fixture and must not be used for general illumination. Anyone with a history of eye damage or sensitivity should avoid using this fixture or looking directly at it.
5. Extreme caution must be exercised when using

it, do not touch high-temperature parts such as flash tubes to avoid burns.

6. Do not point the flash directly at the eyes (especially baby's eyes) under any circumstances, as this could impair vision in a short time. Turn off immediately if discomfort occurs, stop using, and seek medical attention promptly.
7. If the flash tube is damaged, stop using it immediately and contact the manufacturer, service agent, or qualified repair personnel for a replacement to prevent accidents.
8. Do not use damaged equipment or accessories. Allow professional repair technicians to inspect and confirm normal operation before continuing use after repairs.
9. Disconnect power source or remove batteries (if it has one) before replacing flash tube, protective glass, or fuses. Allow 10 minutes to cool before replacing flash tube, and wear insulated or heat resistant gloves when operating.
10. Turn off power before connecting or disconnecting plugs from outlets. Ensure plugs are fully inserted when connecting.
11. Stop using immediately if the product shell is cracked due to falling, squeezing, or strong impact, to avoid touching the internal electronic components and getting an electric shock.
12. Some products have long power cords, please place them properly to avoid contact with heat sources or tripping others. It is recommended to use the original power cord. Damage caused by non-original cords is not covered by the warranty.
13. Unplug the equipment power plug from the power socket before cleaning or maintenance. Do not pull the power cord forcibly, use both hands to hold the plug end and pull it out.
14. This device is not waterproof. Keep it dry and avoid immersing it in water or other liquids. It should be installed in a ventilated and dry location and avoid using in rainy, humid, dusty, or overheated environments. Do not place items above the device or allow liquids to flow into it to prevent danger.
15. Do not disassemble without authorization. If the product malfunctions, it must be inspected and repaired by our company or authorized repair personnel.
16. Before storing the device, ensure it has completely cooled down and the power cord is unplugged, then put it in the protective case or a ventilated dry location.
17. Do not place the device near alcohol, gasoline, or other flammable volatile solvents or gases such as methane and ethane.
18. Do not use or store this device in potentially explosive environments.

19. Maintain at least 1 meter distance between the lamp head and the user, other people, and heat-sensitive or flammable items during and after use.
20. Do not cover the heat dissipation port!
21. Do not use accessories not been approved by our company, as this may cause fire, electric shock or personal injury.
22. Clean gently with a dry cloth. Do not use a wet cloth as it may damage the device.
23. This instruction manual is based on rigorous testing. Changes in design and specifications are subject to change without notice. Check official website for latest instruction manual and product updates.
24. Use only specified charger and follow proper usage instructions for certain products with built-in lithium batteries, within the rated voltage and temperature range.
25. Some products are powered by lithium batteries, who have limited lifespans and will gradually lose their charging capacities, which is irreversible. As the battery ages, the product's battery life will decrease. The lifespan of lithium battery is estimated to be 2 to 3 years. Please regularly check the battery, and if the charging time significantly increases or the battery life significantly decreases, consider replacing the battery.
26. Some products are equipped with lithium batteries. The following are the storage recommendations: Charge the battery to about 50% before storage. Charge it to about 50% at least every six months. Removable batteries should be stored separately. The storage temperature should be between 0°C and 40°C.
27. Some products are powered by lithium batteries. Please note:
  - Do not disassemble, crush, or puncture the battery;
  - Avoid short-circuiting the battery contacts;
  - Do not expose the battery to fire or water;
  - Do not expose the battery to temperatures above 60°C;
  - Keep out of reach of children;
  - Protect the battery from excessive shock or vibration;
  - Do not use a damaged battery;
  - If the battery leaks, avoid contact with the leaking fluid;
  - If the battery fluid comes into contact with your eyes, immediately rinse with water for at least 15 minutes. Lift your eyelids until there are no signs of fluid and seek medical attention promptly.
28. Confirm and comply with all relevant local laws and regulations when handling any batteries.
29. The warranty period for this device as a whole is

one year. Consumables (such as batteries), adapters, power cords, and other accessories are not covered by the warranty.

30. Unauthorized repairs will void the warranty and will incur charges.
31. Failures from improper operation is not covered under warranty.

## Content

- 34 Foreword
- 34 Warning
- 35 Names of Parts
- 36 Power Switch
- 36 Display in Different Modes
- 37 Flash Tube Operating Instructions
- 37 Reflector Operating Instructions
- 39 Flash Bracket for Camera Instructions
- 41 What's Inside
- 42 Separately Sold Accessories
- 42 Touch Screen Instructions
  - 1. Mode
  - 2. Wireless
  - 3. Setting
- 50 Button and Dial Instructions
  - 1. Mode

- 2. Wireless
- 3. Setting
- 55 Over-Temperature Protection
- 55 Other Protections
- 56 Number of flashes that will activate over-temperature protection
- 57 Number of flashes that will activate over-temperature protection in HSS mode
- 58 Technical Data
- 59 Troubleshooting Guide
- 60 Firmware Upgrade
- 61 The Reason & Solution of Not Triggering in Godox 2.4G Wireless
- 62 Maintenance

## Foreword

Thank you for purchasing!

Lux Master, an intelligent retro camera flash that focuses on both external and internal improvements. The design of reflector adopts the principle of traditional Chinese folding fans, achieving minimalist storage through manual extension and retraction.

With its powerful output, it delivers a remarkable GN25 at 1/1 step in M mode. TTL auto flash, A (auto) flash, M (manual) flash, and multi flash give you total creative control. With built-in 2.4G wireless receiver, it works seamlessly with flash triggers like XPROII, X2T and X3 series for remote controlling.

Thoughtful touch screen with features such as power adjustment, mode switching, S1/S2 photocell, and brightness adjustment make it a joy to use. Besides, it's widely compatible with major camera brands, including Canon, Nikon, Fujifilm, Olympus, Sony, Leica and Pentax.

## Warning

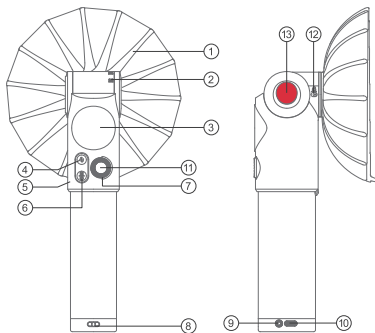

- ▲ The flash tube is fragile, please take it in and place it properly when not in use.
- ▲ Scratches on the reflector caused during using will not affect the normal use.

## Names of Parts



1. Fan Type Reflector
2. Flash Head Angle Scale
3. Touch Screen
4. Test Button/Recycle Indicator
5. Optical Sensor
6. Power Switch/MENU Button
7. Adjust Dial
8. Lanyard Hole
9. SYNC Hole
10. USB-C Port
11. SET Button
12. Accessory Removal Pusher
13. Flash Tube Release

## Power Switch

Power on: Press and hold the power switch/menu button <  > until the display shows "Godox" and <  >, then rotate the adjust dial or the screen clockwise to turn the device on.

Power off: Press and hold the power switch/menu button until the display black out.

## Display in Different Modes



M (Manual) Flash Mode



Multi Flash Mode



A (Auto) Flash Mode



TTL Auto Flash Mode

## Flash Tube Operating Instructions

Eject the flash tube: press the flash tube release button to eject the flash tube.



Take in the flash tube: gently press the flash tube inside until a “click” is heard. It’s suggested to wear gloves for safety reasons.



Note: The recycle indicator will be constant on red when the flash tube is pressed inside, then the flash tube is unavailable to flash.

## Reflector Operating Instructions

Installation: insert the reflector into the mount and rotate clockwise until a “click” is heard. Unfold the reflector clockwise and connect the fan blades with fasteners at both ends.

As there are two fasteners at one of the ends, the reflector can be connected with 14 or 15 fan blades as you wish to achieve different diffusing and zooming effects.

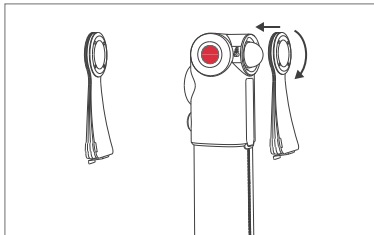

Detachment: push the accessory removal pusher backward and rotate anticlockwise to detach it.

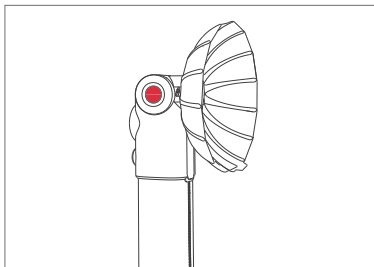

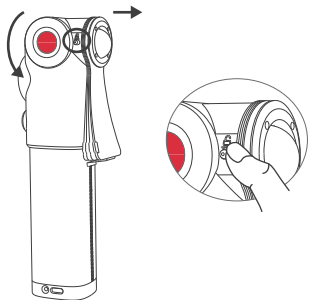

## Flash Bracket for Camera Instructions

Aim the screw hole at the bottom of Lux Master at the screw on the bracket FB01 and insert it, then rotate the screw knob clockwise to tighten. Install the camera on the other side in the same way.

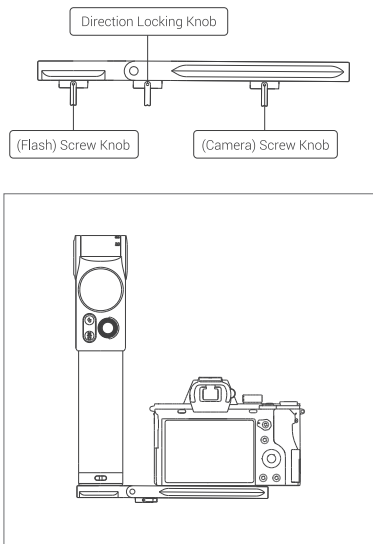



## What's Inside



Flash Body  
x 1



Fan Type Reflector  
LM-R27  
x 1



Flash Bracket  
for Camera FB01  
x 1



Triggering Cable  
x 1



Charging Cable  
x 1



Storage Bag  
x 1



Protection Cover  
for Flash Tube  
x 1



Instruction Manual  
x 1

## Separately Sold Accessories

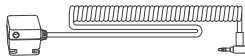

Auto Sensor For  
Lux Master AS-01  
x 1



Reflector with  
Dome LM-R28  
x 1



Fan Type Reflector  
LM-R27  
x 1

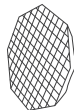

Octa Softbox for Lux  
Master LM-S25  
x 1



Flash Bracket for  
Camera FB01  
x 1

## Touch Screen Instructions

All the parameters can be adjusted on the touch screen, slide down the screen to menu interface, then slide the screen from right to left to mode, wireless and setting.

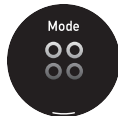

## 1. Mode



In the mode interface, slide up or down can switch among Manual/Multi/Auto/TTL mode, then slide from left to right can return to the previous interface. When the cursor is at the screen bottom, the current parameters are available for further adjusting.



In the parameters adjusting interface, press the "mode display zone" on the right corner can switch among the four modes quickly.



### Mode Display Zone

Press the mode display zone, the following parameters will show up and be adjustable by sliding up or down. Press the <  > on the top to turn on or off the wireless. Press the <  > on the bottom to enter wireless sync, slide the screen rightward to return to the previous interface.

Channel ( CH )	1-32
Group ( GR )	A, B, C, D, E
ID	OFF, 1-99

### Manual Flash Mode

In the manual flash mode interface, press the parameters zone can adjust the power from 1/256 to 1/1 full power or from 2.0 to 10 full power, slide the screen rightward to return to the previous interface.



### Multi Flash Mode

In the multi flash mode interface, press the parameters zone can adjust the power/times/frequency, slide the screen rightward to return to the previous interface.

#### Maximum Multi Flash Times at Different Power

Frequency \ Power	1	2	3	4	5	6-7	8-9	10	11	12-14	15-19	20-50	60-99
1/4 (8.0)	7	6	5	4	4	3	3	2	2	2	2	2	2
1/8 (7.0)	14	14	12	10	8	6	5	4	4	4	4	4	4
1/16 (6.0)	30	30	30	20	20	20	10	8	8	8	8	8	8
1/32 (5.0)	60	60	60	50	50	40	30	20	20	20	18	16	12
1/64 (4.0)	90	90	90	80	80	70	60	50	40	40	35	30	20
1/128 (3.0)	90	90	90	90	90	90	80	70	70	60	50	40	40
1/256 (2.0)	90	90	90	90	90	90	80	70	70	60	50	40	40

## Auto Flash Mode

In the auto flash mode interface, press the reflector icon can switch the four reflector types, slide the screen rightward to return to the previous interface.

Note: Please use the corresponding reflector as chosen to achieve a correct flash output.



Fan Type Reflector



Reflector



Reflector + Diffusion Dome



Octa Softbox

Press the parameters zone can adjust the aperture (F value) and ISO, slide the screen rightward to return to the previous interface. The following is the practical table of auto flash mode.

Step 1	ISO	25	50	100	200	400	800	1600	
	Aperture (F value)	1.4	2	2.8	4	5.6	8	11	
	Distance	Fan Type Reflector					Max. approx. 7.2m		
		Reflector					Max. approx. 12m		
		Reflector + Diffusion Dome					Max. approx. 4m		
Octa Softbox					Max. approx. 4.5m				



Step 2	ISO	25	50	100	200	400	800	1600	
	Aperture (F value)	2	2.8	4	5.6	8	11	16	
	Distance	Fan Type Reflector					Max. approx. 5m		
		Reflector					Max. approx. 8.5m		
Reflector + Diffusion Dome					Max. approx. 2.8m				
Octa Softbox					Max. approx. 3.2m				
Step 3	ISO	25	50	100	200	400	800	1600	
	Aperture (F value)	2.8	4	5.6	8	11	16	22	
	Distance	Fan Type Reflector					Max. approx. 3.6m		
		Reflector					Max. approx. 6.1m		
		Reflector + Diffusion Dome					Max. approx. 2m		
Octa Softbox					Max. approx. 2.3m				

Auto flash mode only supports using with cameras of legacy hot shoe, and the camera flash needs to be collocated with an auto sensor, take AS-01 as an example:

Insert the hot shoe of AS-01 into hot shoe mount of camera, and PC cable on the other end into the sync hole of flash, then adjust the aperture (F value) and ISO of the flash to the same as those of the camera.



## TTL Flash Mode

This TTL flash mode only supports be used as a receiver, and can be controlled by main flash unit (sold separately) with wireless transmitting function.

In the TTL flash mode interface, press the group display zone to enter the parameters adjusting interface. Then press the  on the top to turn on or off the wireless. Press the  on the bottom to enter wireless sync, slide the screen rightward to return to the previous interface.

## 2. Wireless

When you use the flash trigger (take X3 series as an example) to trigger Lux Master, the wireless sync function will help quickly set the channels and IDs of them to the same.







Press the  on the top to turn on or off the wireless. Press the  on the bottom to enter wireless sync, slide the screen rightward to return to the previous interface.







Press the <wireless sync> on the flash trigger, press the  on Lux Master, then they will be wireless synchronized.



## 3. Setting

In the setting interface, press the following icons to enter C. Fn settings. Slide up or down to adjust, slide the screen rightward to return to the previous interface.

Icons	Settings	Options	Notes
	Photocell	S1	It is only available in M (manual) flash mode, the flash will fire synchronously when the main flash fires for the first time.
		S2	It is only available in M (manual) flash mode, the flash will only fire in response to the second, actual flash from the main unit.
	4 Reflector Types	Fan Type Reflector	Only available in Auto mode
		Reflector	
		Reflector + Diffusion Dome	
		Octa Softbox	
	Screen Sleep	Off	Turn off screen sleep function.
		30 SEC	Enter sleep mode after 30 seconds of idle use.
		1 MIN	Enter sleep mode after 1 minute of idle use.
		2 MIN	Enter sleep mode after 2 minutes of idle use.
		3 MIN	Enter sleep mode after 3 minutes of idle use.
		4 MIN	Enter sleep mode after 4 minutes of idle use.
5 MIN	Enter sleep mode after 5 minutes of idle use.		

Icons	Settings	Options	Notes
	Auto Off	Off	Turn off auto off function.
		30 MIN	Power off automatically after 30 minutes.
		60 MIN	Power off automatically after 60
		90 MIN	Power off automatically after 90 minutes.
	Beep	On/Off	Yellow: on. Grey: off.
	Step ( flash output power )	1/256	Flash output power: 1/256 -1/1.
		2.0	Flash output power: 2.0 -1.0.
	Brightness	/	Turn the adjust bar to adjust the brightness.
	Language	English	English system.
		Simplified Chinese	Simplified Chinese system.
	Reset Device	Reset	Restore to factory setting.
		Cancel	Cancel resetting.
	Device Info	/	Display model and firmware version.

## Button and Dial Instructions

### 1. Mode

#### Manual Flash Mode

The flash output power in M (manual) flash mode is adjustable from 1/256 to 1/1 full power or from 2.0 to 10 full power in 0.1 increments. To obtain a correct flash exposure, use a hand-held flash meter to determine the required flash output.

1. Press the menu button to enter the menu interface, turn the adjust dial to mode then press the SET button to enter mode interface.



2. Turn the adjust dial to select Manual, press the SET button to enter manual flash setting, then turn the adjust dial to adjust flash output power.



### S1 Photocell

In M (manual) flash mode, the flash can function as S1 photocell unit, workable as a secondary flash. With this function, the flash will fire synchronously when the main flash fires for the first time, the same effect as that by the use of wireless triggers. This helps create multiple lighting effects.

### S2 Photocell

In M (manual) flash mode, the flash can also function as S2 photocell unit, workable as a

secondary flash. This is useful when cameras have pre-flash function. With this function, the flash will ignore a single “pre-flash” from the main flash and will only fire in response to the second, actual flash from the main unit.

Note: S1/S2 photocell is only available in M (manual) flash mode.

### Multi Flash Mode

With multi flash, a rapid series of flashes is fired. It can be used to capture multiple images of a moving subject, within a flash output power adjustable from 1/256 to 1/1 or from 2.0 to 8.0. You can set the flash frequency (number of flashes per sec. expressed as Hz), the number of flashes, and the flash output.

1. Press the menu button to enter the menu interface, turn the adjust dial to mode then press the SET button to enter mode interface.



2. Turn the adjust dial to select Multi, press the SET button to enter multi flash setting, then turn the adjust dial to adjust flash output power. Press the SET button to select number of flashes or flash frequency (Hz), then turn the adjust dial to adjust parameters respectively.



Number of flashes: 1-90  
Flash frequency (Hz): 1-99

### Calculating the Shutter Speed

During multi flash, the shutter remains open until the firing stops. Use the formula below to calculate the shutter speed and set it with the camera.

### Number of Flashes /Flash Frequency = Shutter Speed

For example, if the number of flashes is 10 and the flash frequency is 5Hz, the shutter speed should be at least 2 seconds.

Note: To avoid overheating and deteriorating the flash head, do not use multi flash more than 10 times in succession. After 10 times, allow the camera flash to rest for at least 15 minutes. If you try to use the multi flash more than 10 times in succession, the firing might stop automatically to protect the flash head. If this happens, allow at least 15 minutes' rest for the camera flash.

### Auto Flash Mode

1. Press the menu button to enter the menu interface, turn the adjust dial to mode then press the SET button to enter mode interface.



2. Turn the adjust dial to select Auto, press the SET button to enter auto flash setting, then turn the adjust dial to adjust the aperture (F value) and ISO. The practical table of this mode refers to the above “touch screen instructions” section.



Note: Using an extra long lens may affect the auto mode output.

### TTL Flash Mode

This TTL auto flash mode only supports be used as a receiver, and can be controlled by main flash unit (sold separately) with wireless transmitting function.

1. Press the menu button to enter the menu interface, turn the adjust dial to mode then press the SET button to enter mode interface.



2. Turn the adjust dial to select TTL, press the SET button to enter TTL auto flash interface.



Note: This mode is only available when the wireless function is turned on.

### High Speed Sync

High speed sync (FP flash) enables the flash to synchronize with all camera shutter speeds. This is convenient when you want to use aperture priority for fill-flash portraits.

High speed sync is only available in a receiver unit by setting on a 2.4G wireless flash trigger, and only supports manual and TTL modes. The flash output is adjustable from 1/64 to 1/1 full power or from 4.0 to 10 full power with 0.1 increment each step.

Note:

With high-speed sync, the faster the shutter speed, the shorter the effective flash range.

Multi flash mode cannot be set in high-speed sync mode.

Over-temperature protection may be activated after consecutive high-speedsync flashes.

## 2. Wireless

Lux Master is equipped with 2.4G wireless receiving function, signals from wireless transmitting flashes can be received.

1. Press the menu button to enter the menu interface, turn the adjust dial to wireless then press the SET button to enter wireless interface.



2. Turn the adjust dial to select among wireless switch, CH, GR, ID, their respective parameters, or wireless sync. Press the SET button to enter the desired interface, then turn the adjust dial to adjust the parameters.



CH: 1-32

GR: A, B, C, D, E

ID: OFF, 1-99

### 3. Setting

Press the menu button to enter the menu interface, turn the adjust dial to setting then press the SET button to enter setting interface. There are 9 setting options in total.

Turn the adjust dial to select among 9 setting options, press SET button to enter the desired setting interface, then turn the adjust dial to adjust the parameters, the details of which refer to the table in the above “touch screen instruction” section.

### Over-Temperature Protection

- To avoid overheating and deteriorating the flash head, the inner over-temperature protection function may be activated and charging turns slow if you fire plenty of continuous flashes. If this occurs, allow a rest time of about 10 minutes, and the flash unit will then return to normal.

- The <  > will be shown on the display if the inner overtemperature protection function is activated.



### Other Protections

The system provides real-time protection to secure the device and your safety. The following lists prompts for your reference:

Prompts on LCD Panel	Meaning
E1	A failure occurs on the recycling system so that the flash cannot fire. Please restart the flash unit. If the problem still exists, please send this product to a maintenance center.
E3	The voltage on two outlets of the flash tube is too high. Please send this product to a maintenance center.

### Number of flashes that will activate over-temperature protection

Flash Output Power	Number of Flashes
1/1	50
1/2	75
1/4	90
1/8	150
1/16	200
1/32	260



1/64	480
1/128	1100
1/256	1100

## Number of flashes that will activate over-temperature protection in HSS mode

Flash Output Power	Number of Flashes
1/1	45
1/2	55
1/4	75
1/8	80
1/16	80
1/32	80
1/64	80
1/128	80
1/256	80

Note: HSS is only available in separately sold flash triggers.

## Technical Data

Model	Lux Master
GN ( 1/1 step )	GN25 ( ISO100, in meters )
Lithium Battery Parameters	DC7.2V, 2980mAh, 21.456Wh
Input Parameters	5V  2A
Charging Time	≈ 2h(5V/2A)
CCT of Flash Head	6200K±200K
Flash Output Power in M Mode	1/1 -1/256 ( with +0.1 increment each step ) or 10 -2.0 ( with +0.1 increment each step )
A (Auto) Flash Mode	Parameters of cameras are F2.8 and ISO100 by default
Photocell	S1 Photocell /S2 Photocell
2.4G Wireless Channels	1-32
2.4G Groups	A, B, C, D, E
2.4G Wireless ID	OFF, 1 -99
2.4G Wireless Transmission Distance	Max. 100m
Sync Mode	First-curtain sync, Second -curtain sync, High-speed sync (available in separately sold flash trigger)
Flash Head Rotatable Angle	0° - 90° ( Four angles with +30° increment each )
Working Environment Temperature	-10°C ~50°C
Recycle Time (1/1 step)	≈ 1.8s
Full Power Flash Times ( 1/1 step )	≈ 460
Battery Charging Temperature	0°C - 45°C
Sync Triggering	Sync cord
Dimension (with reflector)	≈ 5.51 " * 10.24 " * 3.90 "
Net Weight (with reflector)	≈ 470g

Specifications and data may subject to changes without notice.

## Troubleshooting Guide

Please refer to the guide table below when problems occur.

Problem	Possible Reasons	Solution
Flash does not fire	Triggering cable not properly connected	Check that both ends of the triggering cable are plugged into the camera and flash sync holes respectively.
Power down automatically	The screen sleep function is on.	Press any button to wake up
Can not boot up	Battery runs out or damages	Please charge or replace the battery, or contact the after-sales.
Flash does not fire as a receiver unit	The receiver 's flash group is incorrect. For example, group B of the transmitter is off but the receiver is set as group B.	Set the flash group of receiver correctly.
	The channels of transmitter and receiver are inconsistent.	Please set the channels of transmitter and receiver to the same, e.g., set the channel of transmitter to 01, and receiver 's to 01 as well.
	The receiver is out of the transmission distance of the transmitter.	Please set the receiver within the transmission distance of the transmitter (refer to its instruction manual).
	The transmitter and receiver are too close for transmission.	Please set the triggering distance of the transmitter (refer to its instruction manual).
device stuck, no response to button or touching operations.	device software failure	Press the test button and SET button at the same time to forced shutdown, and then reboot to check if it is normal.

Note: The transmitter mentioned above is separately sold, which refers to flashes equipped with wireless transmission function, so the guide table is for reference only, please contact Godox's after-sales in time in case of unsolved problems.

## Firmware Upgrade

1. This product supports firmware upgrade through the USB-C port, please use USB-C cable (sold separately).
2. As the firmware upgrade needs the support of Godox G3 software, please download and install the "Godox G3 firmware upgrade software" from our official website <https://www.godox.com> before upgrading. Then, choose the related firmware file.
3. Please refer to the latest electronic version of the instruction manual.

Upgrading Operation: press "Upgrade", press "Yes" to enter "Upgrade" or press "No" to cancel upgrading.



Note: Please use the Godox G3\_V1.1 or above firmware version, and refer to the latest electronic version of instruction manual.

## The Reason & Solution of Not Triggering in Godox 2.4G Wireless

**1. Disturbed by the 2.4G signal in outer environment (e.g. wireless base station, 2.4G wifi router, Bluetooth, etc.)**

→ To adjust the channel CH setting on the flash trigger (add 10+ channels) and use the channel which is not disturbed. Or turn off the other 2.4G equipment in working.

**2. Please make sure that whether the flash has finished its recycle or caught up with the continuous shooting speed or not (the flash ready indicator is lightened) and the flash is not under the state of over-heat protection or other abnormal situations.**

→ Please downgrade the flash power output. If the flash is in TTL mode, please try to change it to M mode (a preflash is needed in TTL mode).

**3. Whether the distance between the flash trigger and the flash is too close or not (<0.5m).**

→ Please set the triggering distance of the transmitter (refer to its instruction manual).

**4. Whether the flash trigger and the receiver end equipment are in the low battery states or not**

→ Please replace the battery.

## Maintenance

- Shut down the device immediately should abnormal operation be detected.
- Avoid sudden impacts and the product should be dedusted regularly.
- It is normal for the flash tube to be warm when in use. Avoid continuous flashes if unnecessary.
- Maintenance of the flash must be performed by our authorized maintenance department which can provide original accessories.
  - This product, except consumables e.g. flash tube, is supported with a one-year warranty.
  - Unauthorized service will void the warranty.
  - If the product had failures or was wetted, do not use it until it is repaired by professionals.
  - Changes made to the specifications or designs may not be reflected in this manual.

## FCC Statement

This device complies with part 15 of the FCC Rules. Operation is subject to the following two conditions:  
(1) This device may not cause harmful interference, and  
(2) this device must accept any interference received, including interference that may cause undesired operation.

Any Changes or modifications not expressly approved by the party responsible for compliance could void the user's authority to operate the equipment.

Note: This equipment has been tested and found to comply with the limits for a Class B digital device, pursuant to part 15 of the FCC Rules. These limits are designed to provide reasonable protection against harmful interference in a residential installation. This equipment generates uses and can radiate radio frequency energy and, if not installed and used in accordance with the instructions, may cause harmful interference to radio communications. However, there is no guarantee that interference will not occur in a particular installation. If this equipment does cause harmful interference to radio or television reception, which can be determined by turning the equipment off and on, the user is encouraged to try to correct the interference by one or more of the following measures:

- Reorient or relocate the receiving antenna.
- Increase the separation between the equipment and receiver.
- Connect the equipment into an outlet on a circuit different from that to which the receiver is connected.
- Consult the dealer or an experienced radio/TV technician for help.

The device has been evaluated to meet general RF exposure requirement.

The device can be used in portable exposure condition without restriction.

## Warning

Operating frequency:2412.99MHz – 2464.49MHz  
(only receive)

## Declaration of Conformity

GODOX Photo Equipment Co.,Ltd. hereby declares that this equipment are in compliance with the essential requirements and other relevant provisions of Directive 2014/53/EU. In accordance with Article 10(2) and Article 10(10), this product is allowed to be used in all EU member states.For more information of DoC, Please click this web link:  
<https://www.godox.com/eu-declaration-of-conformity/>  
The device complies with RF specifications when the device used at 0mm from your body.

## 产品保修

尊敬的用户，本保修卡是申请保修服务的重要凭证，请您配合销售商填写并妥善保管，谢谢！

产品信息	型号	产品条码
用户信息	姓名	联系电话
	通信地址	
销售商信息	名称	
	联系电话	
	通信地址	
	销售日期	
备注		

注：此表应由销售商盖章确认。

### 适用产品

本文件适用于相关《产品保修信息》(见后面说明)所列产品，其他非属此范围的产品或部件(如促销品、赠品及其他出厂后附加的部件等)不在此保修承诺内。

### 保修期

产品及部件的相应保修期按相关的《产品保修信息》执行。保修期自产品首次购买日起算，购买日以购买产品时保修卡登记日期为准。

### 如何获得保修服务

您可直接与产品销售商或授权服务机构联系，也可拨打神牛产品售后服务电话，与我们联系，由我们的服务人员为您安排服务。申请保修时，您应提供有效的保修卡作为保修凭证，方可获得保修。如您不能提供有效的保修卡，则在我们确认产品或部件属于保修范围的情况下，也可以为您提供保修，但这不作为我们的义务。

### 不适用保修的情况

如产品存在下列情况，本文件项下的保证和服务将不适用：**①产品或部件超过相应保修期；②错误或不适当使用、维护或保管导致的故障或损坏，如：不当搬运；非按产品合理预期用途使用；不当插拨外接设备；跌落或外力挤压；接触或暴露于不适当温度、溶剂、酸碱、水浸或潮湿环境；③由非神牛授权机构或人员安装、修理、更改、添加或拆卸造成的故障或损坏；④产品或部件原有识别信息被修改变更或删除；⑤无有效保修卡；⑥使用非合法授权、非标准或非公开发行的软件造成的故障或损坏；⑦因不可抗力或意外事件造成的故障或损坏；⑧其他非因产品本身**

**质量问题导致的故障或损坏。**遇上述情况，您应向相关责任方寻求解决，神牛对此不承担任何责任。因非在保修期或保修范围内的部件、附件或软件导致产品不能正常使用的，不是保修范围内的故障。产品使用过程中正常的脱色，磨损和消耗，不是保修范围内的故障。

## 产品保修和服务支持信息

产品的保修期和服务类型按以下《产品保修信息》执行：

产品类别	选项名称	保修期 (月)	保修服务类型
部件	电路板	12	客户送修
	电池	3	客户送修
	充电器等带电性能的部件。	12	客户送修
其他	如闪光管、造型灯泡、外壳、保护罩、锁紧装置、包装等。	无	无保修

## Warranty

Dear customers, as this warranty card is an important certificate to apply for our maintenance service, please fill in the following form in coordination with the seller and safe-keep it. Thank you!

Product Information	Model	Product Code Number
Customer Information	Name	Contact Number
	Address	
Seller Information	Name	
	Contact Number	
	Address	
	Date of Sale	
Note:		

Note: This form shall be sealed by the seller.

### Applicable Products

The document applies to the products listed on the Product Maintenance Information (see below for further information). Other products or accessories (e.g. promotional items, giveaways and additional accessories attached, etc.) are not included in this warranty scope.

### Warranty Period

The warranty period of products and accessories is implemented according to the relevant Product Maintenance Information. The warranty period is calculated from the day (purchase date) when the product is bought for the first time. And the purchase date is considered as the date registered on the warranty card when buying the product.

### How to Get the Maintenance Service

If maintenance service is needed, you can directly contact the product distributor or authorized service institutions. You can also contact the Godox after-sale service call and we will offer you service. When applying for maintenance service, you should provide valid warranty card. If you cannot provide valid warranty card, we may offer you maintenance service once confirmed that the product or accessory is involved in the maintenance scope,

but that shall not be considered as our obligation.

### Inapplicable Cases

The guarantee and service offered by this document are not applicable in the following cases: ① **The product or accessory has expired its warranty period;** ② **Breakage or damage caused by inappropriate usage, maintenance or preservation, such as improper packing, improper usage, improper plugging in/out external equipment, falling off or squeezing by external force, contacting or exposing to the improper temperature, solvent, acid, base, flooding and damp environments, etc;** ③ **Breakage or damage caused by non-authorized institution or staff in the process of installation, maintenance, alternation, addition and detachment;** ④ **The original identifying information of product or accessory is modified, alternated, or removed;** ⑤ **No valid warranty card;** ⑥ **Breakage or damage caused by using illegally authorized, nonstandard or non-public released software;** ⑦ **Breakage or damage caused by force majeure or accident;** ⑧ **Breakage or damage that could not be attributed to the product itself.** Once met these situations above, you should **seek solutions from the related responsible parties and Godox assumes no responsibility.** The damage caused by parts, accessories and software that beyond the warranty period or scope is

not included in our maintenance scope. The normal discoloration, abrasion and consumption are not the breakage within the maintenance scope.

## Maintenance and Service Support Information

The warranty period and service types of products are implemented according to the following Product Maintenance Information:

Product Type	Name	Maintenance Period(month)	Warranty Service Type
Parts	Circuit Board	12	Customer sends the product to designated site
	Battery	3	Customer sends the product to designated site
	Electrical parts e.g.battery charger, etc.	12	Customer sends the product to designated site
Other Items	Flash tube, modeling lamp, lamp body, lamp cover, locking device, package, etc.	NO	Without warranty

Godox After-sale Service Call +86-755-29609320(8062)