

705-ML6000-00

# Godox

## ML60 LED摄影灯

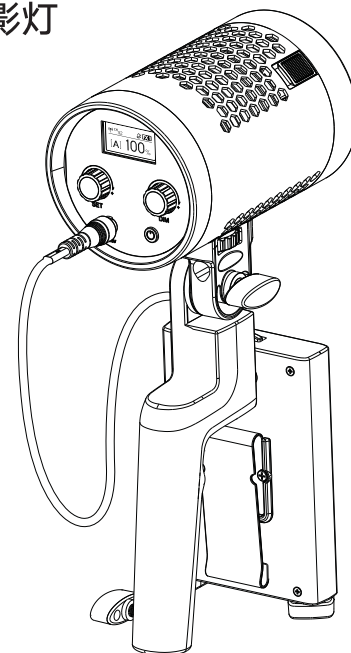

深圳市神牛摄影器材有限公司

地址: 深圳市宝安区福海街道塘尾社区澜川工业区厂房2栋

电话/Tel: +86-755-29609320(8062) 传真/Fax: +86-755-25723423 邮箱/E-mail: godox@godox.com

**GODOX Photo Equipment Co., Ltd.**

Add: Building 2, Yaochuan Industrial Zone, Tangwei Community, Fuhai Street, Bao'an District,

Shenzhen, China Tel: +86-755-29609320(8062) Fax: +86-755-25723423 E-mail: godox@godox.com

godox.com

Made in China



说明手册

Instruction Manual

# 前言

感谢您购买神牛产品！

LED摄影灯ML60是一款高亮度，无线调控的常亮灯，适用于任何场景：直播、野外露营、自拍、静物拍摄、化妆照明、视频录播、婚纱摄影、儿童拍摄及有限空间内补光；轻松动感补光、轻巧便携，操作便捷。

产品有以下亮点：

- 一灯多用，随心切换LED常亮模式和8种情景特效模式
- 0%~100%精确调节亮度
- 16组32频道无线分组调控
- 静音非静音模式随心切换，创作无干扰
- 体积轻巧，方便手持，自由布光

## 警告

- △ 保持干燥：请勿用湿手接触产品，亦不可将产品浸入水中或暴露于雨中。
- △ 请勿私自拆卸产品，如产品出现故障须由本公司或授权的维修人员进行检查维修。
- △ 请勿让儿童接触本产品。
- △ 本产品不能防水，在雨天及潮湿环境下请注意防水。
- △ 请勿在化学品、可燃性气体或其他特殊物质附近使用摄影灯。在这些场合下，请注意相关警告标识。
- △ 请使用专用的充电器进行充电，并且正确的按照操作说明，在规定的电压、温度范围内使用。

# 部件名称

## • 灯头

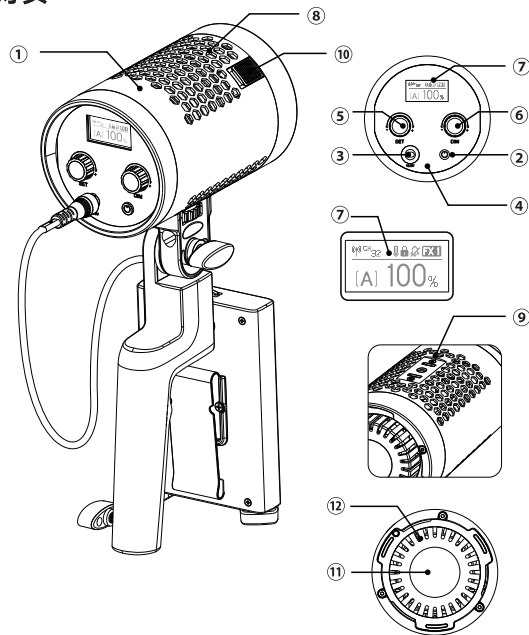

- |             |              |
|-------------|--------------|
| 01. 机身      | 07. 显示屏      |
| 02. 开关按键    | 08. 散热孔      |
| 03. DC电源插孔  | 09. 手柄支架固定螺孔 |
| 04. 控制面板    | 10. 卡口推制     |
| 05. SET按键旋钮 | 11. LED灯     |
| 06. DIM按键旋钮 | 12. 散热器      |

## • 手柄

- 13. 手柄支架
- 14. 手柄方向调节旋钮
- 15. 手柄固定灯头旋钮
- 16. 灯架固定旋钮
- 17. 手柄电池盒固定扣

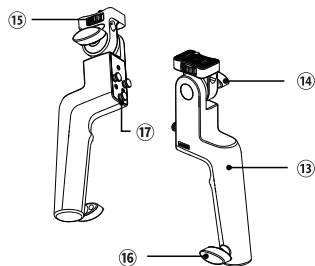

## • 电池盒

- 18. 电池背夹
- 19. 手柄电池盒固定孔
- 20. 手柄电池盒固定推制
- 21. NP-F970电池充卡槽1和2
- 22. 电池电量显示按键/电池装卸推制
- 23. 电量指示灯
- 24. 电池盒站立支撑脚
- 25. 电池供电输出口

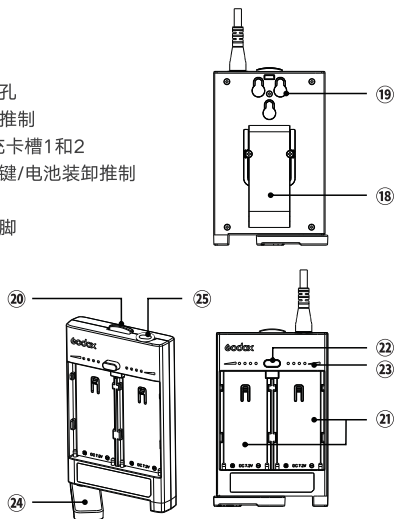

## 标配物品

灯头ML60 x1 手柄 x1 电池盒BC60 x1 适配器 x1 适配器固定座 x1

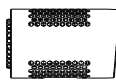

反光罩 x1

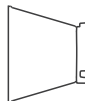

灯头保护盖 x1



AC电源线5M x1



DC电源线1.5M x1



DC电源线0.2M x1



背夹扣 x1  
背夹扣带 x1



便携包 x1



说明书 x1



## 电源管理

适配器供电：输入：100-240V ~ 50/60Hz 2.5A，输出：16.8V 4.2A。  
外置电池供电：电池盒上装2个NP-F970，用电源连接线连接电池盒跟灯头即可供电。

# 功能使用操作说明

## 1. 开关机

短按开关按键，控制机子的打开和关闭，OLED显示主机当前信息。



## 2. 模式选择：常亮模式/FX特效模式

按SET按键进入菜单，旋转SET旋钮至FX,再旋转DIM旋钮切换模式：

**常亮模式：**FX模式为OFF时即为常亮模式。

**特效模式：**情景特效模式有8种FX1 ~ FX8：

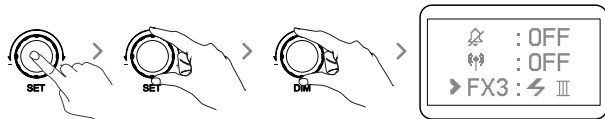

特效	Fx1	Fx2	Fx3	Fx4	Fx5	Fx6	Fx7	Fx8
图标	⚡ I	⚡ II	⚡ III	⚡# I	⚡# II	⚡# III	📺	💡
场景	雷闪电间歇	雷闪电频繁	雷闪电持续	闪光灯	发布会	狗仔队	电视机	坏灯泡

## 3. 2.4G无线设置：

**开关2.4G无线：**按SET按键进入菜单，旋转SET旋钮至无线符号，再旋转DIM旋钮开或关2.4G无线。

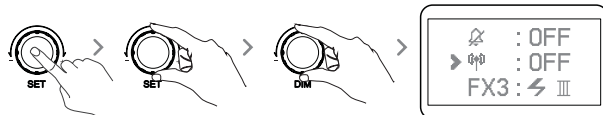

**通道CH设置：**按SET按键进入菜单，旋转SET旋钮至CH,再旋转DIM旋钮设置通道，有32(1-32)个通道供选择。

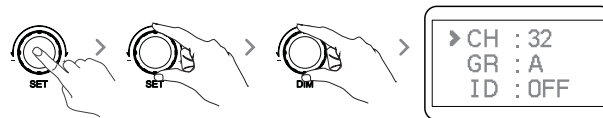

**组别GR设置：**按SET按键进入菜单，旋转SET旋钮至GR,再旋转DIM旋钮设置组别，有16组(A-E,0-9)组别供选择。

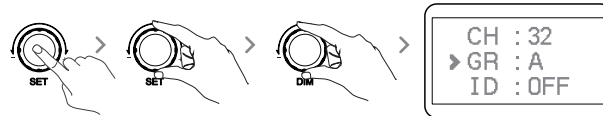

**ID设置：**按SET按键进入菜单，旋转SET旋钮至ID,再旋转DIM旋钮设置ID,有99(1-99)个ID供选择。

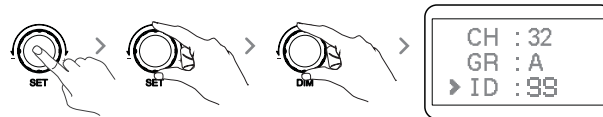

#### 4.亮度调节：

直接在主界面旋转DIM调节亮度。

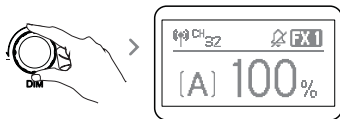

#### 5.静音模式开启：显示屏主界面显示静音模式。

开启静音模式：按SET按键进入菜单，旋转DIM旋钮打开或关闭静音模式，设置为OFF时为非静音模式，设置为ON时为静音模式。

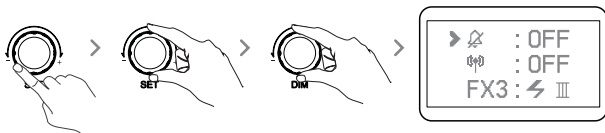

#### 6.装卸电池盒：

6.1装电池盒：电池盒固定孔卡入手柄

电池盒固定扣，卡好后往下拉电池盒，听到咔声表示已装好电池盒。

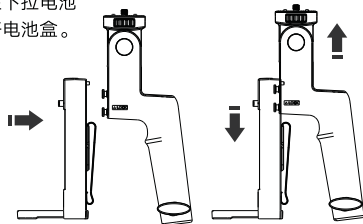

6.2拆卸电池盒：扣住手柄电池盒固定推制往上推电池盒，再往外拿出电池盒。

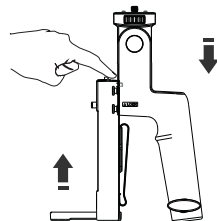

6.3 连接电池盒和灯头：用电源线带卡位一端插入电池盒，另一端插入灯头DC插座。

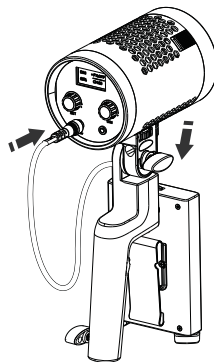

6.4 电池盒装入2个FP970电池即可通电。

## 产品参数

LED摄影灯	<b>ML60</b>
适配器	输出16.8V 4.2A
功率	最大78W
频道	32个
组别	16组 ( A B C D E F, 0-9 )
调光范围	0%~100%
100%光照度(LUX)	最大140000
CRI ( ≈ )	96
TLCI ( ≈ )	96.5
工作环境温度	-10~40°C
重量	0.77Kg ( 不含手柄和反光罩 )
产品尺寸	145x88x 88mm ( 不含手柄和反光罩 )

\* 设计和规格如有变更，恕不另行通知。

## 维护保养

- 为了防止灰尘的堆积影响到产品的性能，请定时用干净的湿布轻轻擦拭产品外部。
- 1年保修，消耗品电池，充电器，充电器电源线等配件不在此保修范围内。
- 对于不规范操作引起的机器故障不在保修范围内。
- 所有维修概由本厂指定可供原厂配件之维修部负责。
- 经发现，擅自检修本品，将取消一年保修期，维修需要收取相关费用。
- 如果本品出现故障或者被水淋湿，在专业人员维修后方可继续使用。
- 如有技术更改，恕不另行通知。

# Foreword

Thank you for purchasing this Godox Product!

This LED Light ML60 is a RGB continuous light with wireless adjustment and 8 FX situational special effects. Suitable for almost all shooting occasions e.g. live, camping, make up, portrait shooting, make up, video, wedding, children photography, etc. It's portable and easy to be operated.

### Features:

- Freely switch LED continuous light mode and 8 FX situational special effects modes
- 0% to 100% Precisely adjust light brightness
- 16 Groups and 32 channels wireless remote control
- Switch silent mode to light without interference
- Compact and lightweight, easy to be held in hand

## ⚠ Warning

- ⚠ Always keep this product dry. Do not use in rain or in damp conditions.
- ⚠ Do not disassemble. Should repairs become necessary, this product must be sent to an authorized maintenance center.
- ⚠ Keep out of reach of children.
- ⚠ As this product do not have waterproof function, please take measures of waterproof in rainy or damp environment.
- ⚠ Do not use the flash unit in the presence of flammable gases, chemicals and other similar materials. In certain circumstance, these materials may be sensitive to the strong light emitting from this flash unit and fire or electromagnetic interference may result.

# Parts

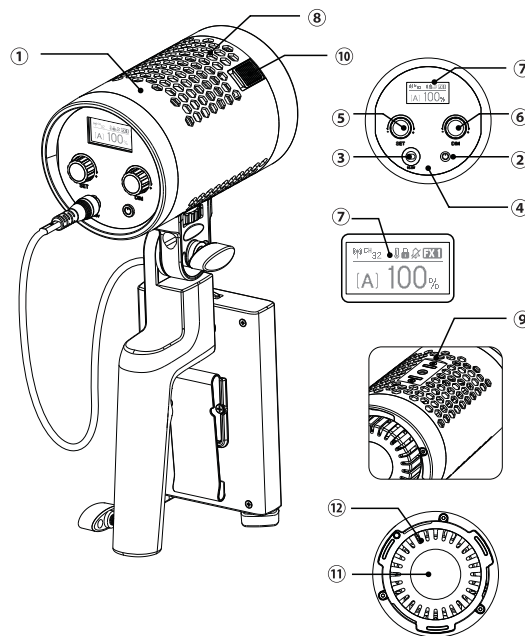

- |                     |                              |
|---------------------|------------------------------|
| 01. Body            | 07. Display                  |
| 02. Power Switch    | 08. Thermovent               |
| 03. DC Power Socket | 09. Fixing Socket for Handle |
| 04. Control Panel   | 10. Accessory Locking Ring   |
| 05. SET Select Dial | 11. LED Light                |
| 06. DIM Select Dial | 12. Radiator                 |

## • Handle

- 13. Handle Bracket
- 14. Direction Adjusting Ring
- 15. Fixing Screw for Light Head
- 16. Fixing Screw for Light Stand
- 17. Fixing Buckle for Battery Case

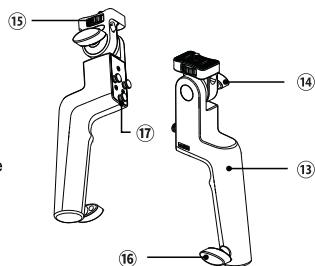

## • Battery Case

- 18. Clip
- 19. Fixing Hole for Battery Case
- 20. Locking Ring for Battery Case
- 21. NP-F970 Battery Compartment 1 and 2
- 22. Battery Level Display Button/  
Battery Locking Ring
- 23. Battery Level Indicator
- 24. Battery Case Leg
- 25. Battery Power Output Port

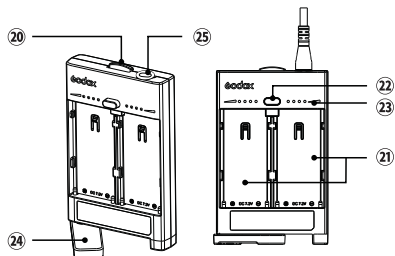

## What's in the Box

Light Body MI60  
x1

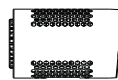

Handle x1



Battery Case  
BC60 x1



Adapter x1



Adapter Holder x1



Reflector x1

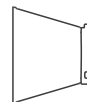

Protect Cover x1



5m AC Power Cable  
x1



1.5m DC Power Cable  
x1



0.2m DC Power Cable x1



Fastener x1  
Clip x1



Portable Bag x1



Instruction Manual x1



## Power Management

### 1. Power Supply

Adapter power supply: input: 100-240V~50/60Hz 2.5A, output: 16.8V 4.2A.

External battery power supply: install two NP-F970 batteries into the battery compartment. Then, use the power cable to connect the battery case with the light body to achieve power supply.



# Operation

## 1. Power On

Press the power switch to control the on/off of the light, and the OLED display will show the current information.



## 2. Mode Selection: Continuous Lighting Mode/FX Special Effects Mode

Press SET button to enter the menu. Turn the SET select dial to FX and screw the DIM select dial to switch the two modes:

Continuous lighting mode: set FX mode to OFF to enter continuous lighting mode.

Special effects mode: there are 8 situational special effects from FX1 to Fx8.

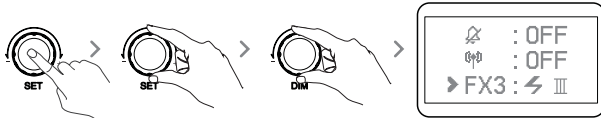

Special Effects	Fx1	Fx2	Fx3	Fx4	Fx5	Fx6	Fx7	Fx8
Icon	⚡ I	⚡ II	⚡ III	⚡ IV	⚡ V	⚡ VI	⚡ VII	💡
Situation	Lightning intervals	Lightning frequent	Lightning sustainable	Flash	Conference	Paparazzi	TV	Broken bulb

## 3. 2.4G Wireless Setting

Turn on/off 2.4G wireless: press SET button to enter the menu. Turn the SET select dial until the wireless icon is displayed. Then, turn the DIM select dial to turn on or off 2.4G wireless.

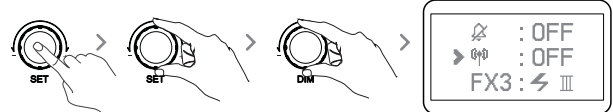

**Channel CH setting:** press SET button to enter the menu. Turn the SET select dial until the CH is displayed. Then, turn the DIM select dial to choose channel from 1 to 32.

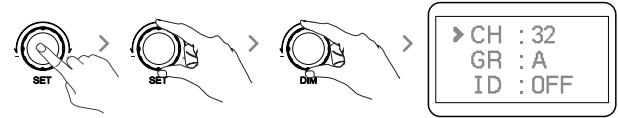

**Group GR setting:** press SET button to enter the menu. Turn the SET select dial until the GR is displayed. Then, turn the DIM select dial to choose group from A to E and 0 to 9.

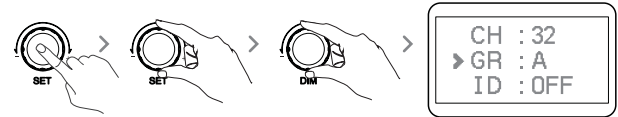

**ID setting:** press SET button to enter the menu. Turn the SET select dial until the ID is displayed. Then, turn the DIM select dial to choose 99 IDs from 1 to 99.

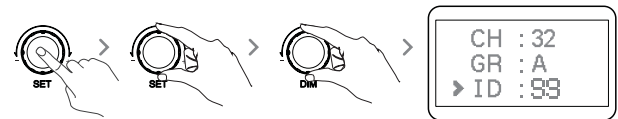

**4. Brightness adjustment:** turn the DIM select dial to adjust brightness.

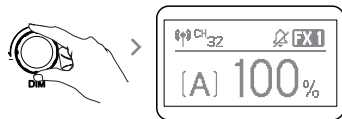

**5. Silent mode:**

when  is displayed, the silent mode is turned on.

Turn on the silent mode: press SET button to enter the menu. Then, screw the DIM select dial to turn on or off the silent mode. Set  to off to enter non-silent mode while set it to on to enter silent mode.

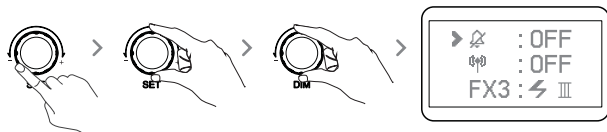

**6. Install and detach battery case**

6.1 Install battery case: Aim the handle's fixing buckles into the battery case's fixing holes, pull the batter case downwards until being tightened.

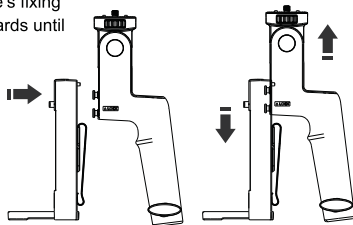

6.2 Detach battery case: push the battery case' locking ring and push the battery case upwards to take it out.

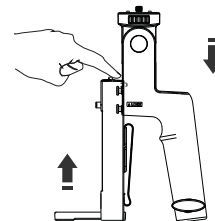

6.3 Connect the battery case with light head: insert the one end with clamping buckle of the power cable into the battery case while another end into the DC power socket of the light head.

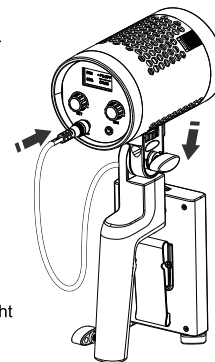

6.4 Insert two FP970 batteries, and the LED light can be put into usage.

## Technical Data

LED Light	Mi60
Adapter	Output: 16.8V 4.2A
Power	Max. 78W
Channel	32
Group	16(A B C D E F,0-9)
Brightness Adjusting Range	0%~100%
100% Illuminance(LUX)	Max. 140000
CRI(≈)	96
TLCI(≈)	96.5
Working Temperature	-10~40°C
Weight	0.77Kg(not include handle and reflector)
Dimension	145x88x 88mm(not include handle and reflector)

\* Product design and specifications are subject to change without notice.

## Maintenance

This product, except consumables e.g. charger and charger cable, is supported with a one-year warranty.

Avoid sudden impacts and the product should be dedusted regularly.

Maintenance of the flash must be performed by our authorized maintenance department which can provide original accessories.

Unauthorized service will void the warranty.

If the product had failures or was wetted, do not use it until it is repaired by professionals.

Changes made to the specifications or designs may not be reflected in this manual.

## FCC Statement

This device complies with part 15 of the FCC Rules. Operation is subject to the following two conditions: (1) This device may not cause harmful interference, and (2) this device must accept any interference received, including interference that may cause undesired operation.

Any Changes or modifications not expressly approved by the party responsible for compliance could void the user's authority to operate the equipment.

**Note:** This equipment has been tested and found to comply with the limits for a Class B digital device, pursuant to part 15 of the FCC Rules. These limits are designed to provide reasonable protection against harmful interference in a residential installation. This equipment generates uses and can radiate radio frequency energy and, if not installed and used in accordance with the instructions, may cause harmful interference to radio communications. However, there is no guarantee that interference will not occur in a particular installation. If this equipment does cause harmful interference to radio or television reception, which can be determined by turning the equipment off and on, the user is encouraged to try to correct the interference by one or more of the following measures:

- Reorient or relocate the receiving antenna.
- Increase the separation between the equipment and receiver.
- Connect the equipment into an outlet on a circuit different from that to which the receiver is connected.
- Consult the dealer or an experienced radio/TV technician for help.

### Warning

Operating frequency:2412.99MHz – 2464.49MHz (only receive)

### Declaration of Conformity

GODOX Photo Equipment Co.,Ltd. hereby declares that this equipment are in compliance with the essential requirements and other relevant provisions of Directive 2014/53/EU. In accordance with Article 10(2) and Article 10(10), this product is allowed to be used in all EU member states.For more information of DoC, Please click this web link: [https://www.godox.com/DOC/Godox\\_ML60\\_DOC.pdf](https://www.godox.com/DOC/Godox_ML60_DOC.pdf)

The device complies with RF specifications when the device used at 0mm from your body.