



Godox



Wechat
Official Account
神牛微信公众号

深圳市神牛摄影器材有限公司

地址: 深圳市宝安区福海街道塘尾社区耀川工业区厂房2栋
电话: 0755-29609320(8062) 传真: 0755-25723423 邮箱: godox@godox.com

GODOX Photo Equipment Co., Ltd.

Add.: Building 2, Yaochuan Industrial Zone, Tangwei Community, Fuhai Street, Bao' an District, Shenzhen 518103, China Tel: +86-755-29609320(8062) Fax: +86-755-25723423
E-mail: godox@godox.com

www.godox.com

Made in China | 705-C10R00-01

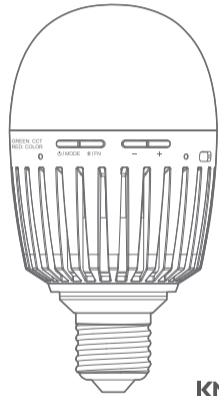

KNOWLED C10R

RGBWW 影视创意灯泡
KNOWLED RGBWW Creative Bulb

使用手册
Instruction Manual

重要的安全说明及注意事项

首先作为最基本原则：本产品为专业灯光布景设备，应由专业灯光师使用或在专业人士指导下使用。使用时必须始终遵循基本的安全预防措施，具体安全预防措施如下：

1. 使用前必须阅读并理解产品说明书。
2. 专业灯具，禁止儿童使用。当儿童靠近时，家长或监护人必须密切监督，以免儿童因碰撞灯具或私用灯具造成人身伤害。
3. 本灯具并非普通照明灯具，不可用于普通照明，任何有过眼部损伤或眼部敏感的人群均应避免使用本灯具。
4. 灯具点亮时，必须小心使用，禁止接触高温部件，如 LED 灯珠，以免造成灼伤。
5. 灯具点亮时，任何情况下均禁止直视灯珠。应该在专业灯光师指导下使用强光，任何情况下避免长时间处于强光环境，如引起眼睛不适，请及时关闭灯具，暂停使用，请及时就医。
6. 倘灯珠损坏或因热变形，应停止使用，并及时联系制造商、服务代理商或合格的维修人员更换灯珠，以免发生意外。
7. 本产品仅适用于 $-10^{\circ}\text{C}\sim+40^{\circ}\text{C}$ 工作环境温度及正常湿度环境下使用。
8. 请勿使用损坏的设备或设备配件，待专业维修人员检查维修，确认设备正常方可使用。
9. 在使用过程中，如果本产品由于跌落、受到挤压或遭受强烈冲击而造成外壳破裂的，请勿继续使用，以免因接触到内部电子元件而受到电击伤害。
10. 如需要延长线，请使用额定电流 \geq 该设备额定电流的延长线。如延长线额定电流小于该设备，可能导致过热。
11. 部分产品电源线较长，请合理放置电源线，使其处于安全位置。避免电源线接触过热物体表面、避免放置不当导致拉扯损坏或绊倒现场人员。请使用本厂原装电源线，如使用非本厂电源线导致产品损坏，概不在本厂维修范围内。
12. 在清洁和维修之前，请务必从电源插座上拔出该设备插头。不使用时，禁止拉扯电源线以将设备插头从电源插座中拔出。正常断电，应是用手抓住该设备插头两端，将插头从电源插座中拔出。此设备需连接到接地插座中。
13. 本设备没有防水性能，请让设备保持干燥，请勿将本设备浸入水中或其他液体中。设备需安装在干燥且通风处，避免在雨天、潮湿、多尘或过热环境下使用。请勿将任何物体置于灯具上或使液体流入灯具内部，以免发生意外。
14. 请勿私自拆卸产品，如产品出现故障，须由本公司或授权的维修人员进行检查维修。

15. 存放本设备之前，请确保设备已完全冷却。存放时，将电源线从设备上拔出。设备应放置于设备便携包内或通风干燥处。
16. 请勿将设备放置在酒精、汽油等易燃易挥发的溶剂附近。
17. 本厂不推荐的产品附件，请勿使用，以免导致火灾、触电或人身伤害。
18. 清洁本设备时，请勿用湿布擦拭，请用干布，软布擦拭设备污垢。
19. 设备使用前，请注意将保护罩取下。
20. 本产品已通过 ROHS、CE、FCC 认证，请参考相关国家标准使用和操作。
21. 安全说明依据本厂严格测试制定，设备设计和规格如有变更，恕不另行通知。客户可以上神牛官网查看最新的电子版说明，了解产品最新资讯。
22. 部分产品内置锂电池。此类产品请使用专用的充电器进行充电，并且按正确的操作说明，在规定的电压、温度范围内使用。
23. 部分产品使用电池供电。此类产品请勿使用说明书中未指定的任何电池、电源或附件。请将电池和其他附件置于儿童及婴幼儿无法触及之处。如果儿童或婴幼儿吞下电池或附件，请立刻就医。如果电池漏液、变色、变形、冒烟或发出异味，请立刻将其取出。在取出过程中请小心，以免烫伤。如果继续使用，可能会引起火灾、触电或皮肤烫伤。请勿使用任何变形或改造过的电池。请勿拆卸或改造本产品或电池。请勿加热电池或焊接电池。请勿让电池与火或水接触。请勿让电池受到强烈的外力撞击。请勿将电池的正负端错误插入，或将新旧电池或不同类型的电池混合使用。
24. 一年保修期，消耗品电池、适配器、电源线等配件不在此保修范围内。
25. 经发现，擅自检修设备，将取消一年保修期，维修需要收取相关费用。
26. 对于不规范操作引起的机器故障不在保修范围内。

保存这些说明

前言

感谢您购买神牛产品！

C10R 是一款 RGBWW 影视灯泡，支持亮度可调、色温可调、彩光可调、AC/DC 供电，通过“Godox light”APP 可用 RGBWW 混光、HSI 彩光、色片、14 类 FX 光效等实用光效；常适用于影视制作、电影拍摄等场景。

警告

- ▲ 请勿私自拆卸产品，如产品出现故障须由本公司或授权的维修人员进行检查维修。
- ▲ 本产品不能防水，在雨天及潮湿的环境下注意防水。
- ▲ 在不使用时，请断开电源。
- ▲ 长时间使用，灯体外壳高温，请勿触碰以免烫伤。

部件名称

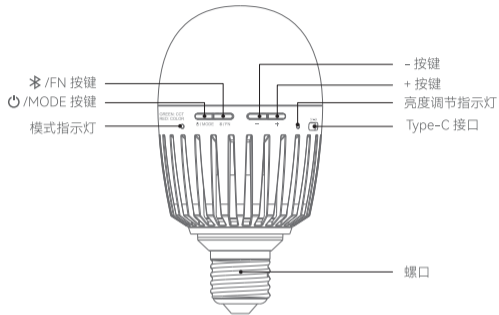

物料清单



灯体 *1



收纳袋 *1



Type-C 电源线 *1



说明书 *1

供电

AC 供电

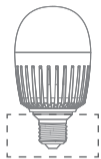

螺旋灯座

E26:100V-120V~50/60Hz 130mA
E27:200V-240V~50/60Hz 65mA

DC 供电

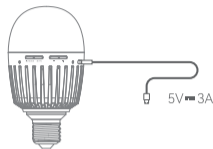



开机 / 关机

接通电源后, 长按  /MODE 按键 2 秒实现开机 / 关机。

亮度调节



通过短按 - 按键或 + 按键切换灯泡亮度档位, 共有 10 个档位, 每档以 10% 为增量; 支持快调, 长按 - 按键或 + 按键可快速调节, 调节范围 0%-100%; 还能通过“Godox Light”APP 调节灯泡亮度, 调节范围: 0%-100%。

色温模式

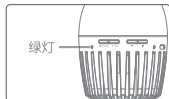
短按  /MODE 按键切换至色温模式, 此时模式指示灯呈现常亮绿灯。短按  /FN 按键进行色温调节, 共有 6 档色温: 2000K、2700K、3200K、4300K、5500K、6500K, 支持循环调节, 快速短按两次  /FN 按键返回上一个选项; 还能通过“Godox Light”APP 调节色温和红绿矫正, 色温调节范围: 2000K-10000K。红绿矫正调节范围: -50~+50。



彩光模式

短按  /MODE 按键切换至彩光模式, 此时模式指示灯呈现常亮红灯。短按  /FN 按键进行彩光调节, 共有 9 档彩光: 红色、绿色、蓝色、蓝绿色、品红色、黄色、粉色、紫罗兰色、橙色, 支持循环调节, 快速短按两次  /FN 按键可返回上一个选项; 还能通过“Godox Light”APP 使用 RGBW 模式、HSI 模式、色片 GEL 模式、FX 光效模式及拾色器。

注: 使用灯体控制时, 彩光默认饱和度为 100%。

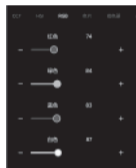

蓝牙设置

蓝牙重置: 长按  /FN 按键直至蓝光闪烁 3 次, 蓝牙重置完毕, 自动返回原来光效。

APP 下载: 扫描二维码即可下载“Godox Light”手机 APP (安卓和苹果系统都可以使用)。

注: 首个移动设备 (手机或平板电脑) 可直接使用 APP 操控灯体。更换其他移动设备时, 灯体需进行蓝牙重置方可正常使用 APP。
蓝牙默认开启, APP 需要升级至 V3.0 以上版本。



规格参数

型号	C10R
功率	最大 12W
DC 输入	5V = 3A
AC 输入	100V~120V~50/60Hz 130mA/200V~240V~50/60Hz 65mA
适用灯座类型	E26/E27
色温(APP 上调节)	2000K-10000K
亮度(APP 上调节)	0%-100%
平均 TLCI	≥97
平均 CRI	≥96
照度数据 (灯体亮度 100%, 色温为 5500K)	≈470Lux/44fc(1.64 英尺 /0.5 米) ≈130Lux/12fc(3.28 英尺 /1 米)
控制方式	蓝牙 APP 控制 / 灯体控制
蓝牙控制距离	最远 30 米
工作环境温度	-10°C~40°C
尺寸	73mm*73mm*136mm
净重	236g

规格参数如有变更, 恕不另行通知。

本设备包含型号核准代码为 :CMIITID:2020DP13510, 为该产品的无线电发射模块。

Safety Instructions and Attentions

First of all, as the most basic principle: This product is a professional lighting set equipment and should be used by professional lighting engineers or under the guidance of professionals. Basic safety attentions must always be followed during use, as follows:

1. Before use, please read and understand these instructions and attentions.
2. Professional lighting is prohibited for children. When children are near, parents or accompanying persons must supervise closely to prevent children from personal injury due to collision with lamps or private use of lamps.
3. This lighting product is not ordinary lighting product and cannot be used for general lighting. Anyone who has suffered eye damage or has sensitive eyes should avoid using this product.
4. When the lamp is on, it must be used with care. Do not touch high-temperature parts, such as LED lamp beads, to avoid burns.
5. When the lamp is on, it is forbidden to look directly at the lamp beads under any circumstances. Strong light should be used under the guidance of professional lighting engineers. Avoid prolonged exposure to strong light under any circumstances. If eye discomfort, please turn off the lamp in time, suspend use, and see a doctor immediately.
6. If the lamp bead is damaged or deformed by heat, stop using this equipment, and contact the manufacturer, service agent or qualified maintenance personnel to replace the lamp bead in time to avoid accidents.
7. This product is only suitable for use in -10°C to +40°C operating environment and normal humidity environment.
8. Do not use damaged equipment or accessories, and wait for professional maintenance personnel to check and repair to confirm being normal before use.
9. During using, if the casing of this product is broken due to being dropped, squeezed or subjected to strong impact, please do not use it, so as to avoid electric shock injury due to contact with internal electronic components.
10. If an extension cord is required, please use an extension cord with a current rating greater than or equal to that of the equipment. If an extension cord is rated less than the equipment, overheating may result.
11. Some products have long power cords, please place the power cords properly and keep them in a safe place. Avoid contacting the power cord with overheating surfaces, avoid improper placement that could cause pulling damage, or trip on-site personnel. Please use the certified power cord from the original manufacturer. If the product is damaged by using a non-certified power cord, it will not be repaired by our factory.

12. Be sure to unplug equipment from the power outlet before cleaning and repairing. When not in use, do not pull the power cord to unplug the equipment. For normal power-off, please hold both ends of the plug of the equipment with your hands and pull the plug out of power outlet. This equipment needs to be connected to a grounded outlet.
13. This equipment is not waterproof, please keep it dry and do not immerse it in water or other liquids. The equipment should be installed in a dry and ventilated place, and avoid using it in rainy, humid, dusty or overheated environments. Do not place any objects on the lamp or let liquid flow into the lamp to avoid accidents.
14. Do not disassemble the product without permission. If the product fails, it must be checked and repaired by authorized maintenance personnel.
15. Before storing, make sure that the equipment has cooled down completely. For storage, unplug the power cord from the equipment. The equipment should be placed in the carrying case or in a ventilated dry place.
16. Do not place equipment near flammable and volatile solvents such as alcohol and gasoline.
17. Do not use accessories that are not recommended by our factory to avoid fire, electric shock or personal injury.
18. When cleaning, do not wipe it with a damp cloth, please use a dry cloth or a soft cloth to wipe the dirt of the equipment.
19. Please take off the protective cover before using.
20. This product complies with ROHS, FCC and CE certification, please refer to the relevant national standards for use and operation.
21. The safety instructions are formulated according to the strict testing of the factory, and the design and specifications of the equipment are subject to change without prior notice. For latest product information, please check the GODOX website and view latest electronic instruction.
22. Some products have built-in lithium batteries. Please use specified chargers, and use them within a proper range of the specified voltage and temperature according to the correct operating instructions.
23. Some products are battery powered. Do not use any batteries, power sources or accessories not specified in the instructions for such products. Keep batteries and other accessories out of the reach of children and infants. In the instance that a child or infant swallows a battery or accessory, immediate emergency medical attention is required. If the battery leaks, becomes discolored, deformed, emits smoke, or emits an abnormal odor, remove it immediately. Be careful during removal to avoid burns. Continued use could result in fire, electric shock, or burns. Do not use any deformed or modified batteries. Do not disassemble or modify this product or battery. Do not heat or solder the battery. Keep the battery away from fire or water. Do not incorrectly insert the positive and negative ends of batteries, or mix old and new batteries or batteries of different types together.

24. One-year warranty period, accessories such as consumable batteries, adapters, power cords, etc. are not covered by this warranty.
25. If it is found that the equipment is repaired without authorization, the one-year warranty period will be cancelled and relevant fees will be charged for maintenance.
26. Machine failures caused by non-standard operation are not covered by the warranty.





keep these instructions!

Foreword

Thank you for purchasing!

Powered by AC/DC power source, KNOWLED RGBWW creative bulb C10R is featured with adjustable brightness, color temperature and HSI. It can achieve RGBWW mode, HSI mode, color filters and 14 FX modes when collocating with "Godox light" APP.

Warning

-  Do not disassemble. Should repairs become necessary, this product must be sent to an authorized maintenance center.
-  Always keep this product dry. Do not use in rain or in damp conditions.
-  Please shut off the power source when not in use.
-  The light body shell will be hot after long time use, do not touch.

Name of Parts

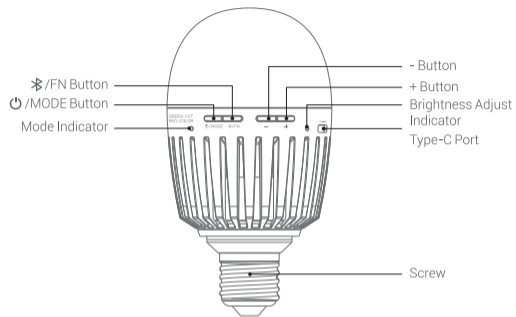

What's Inside



Light Body*1



Storage Bag*1



Type-C Power Cable*1



Instruction Manual*1

Power Source

AC Power Supply



E26:100V-120V~50/60Hz 130mA
E27:200V-240V~50/60Hz 65mA

DC Power Supply

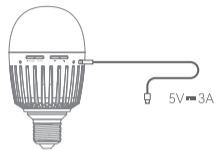

Power Switch

Long press the /MODE button for 2s to power on/off the device after connecting to the power source.

Brightness Adjustment

Short press the - button or + button to switch the brightness among 10 levels from 0 % to 100 % with 10 % of increment each stop. Quick adjustment is available by long pressing the - button or + button. The brightness is also adjustable through "Godox Light" APP from 0% to 100%.

CCT Mode

Short press the /MODE button to CCT mode, the mode indicator will be constant on green. Short press the /FN button to adjust CCT among 6 levels in cycle: 2000K, 2700K, 3200K, 4300K, 5500K and 6500K. Short press the /FN button quickly twice can return to the previous menu. The CCT (2000K~10000K) and GM (-50~+50) are also adjustable through "Godox Light" APP.

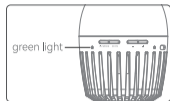

HSI Mode

Short press the /MODE button to HSI mode, the mode indicator will be constant on red. Short press the /FN button to switch among the following 9 colors in cycle: red, green, blue, cyan, magenta, yellow, pink, violet and orange. Short press the /FN button quickly twice can return to the previous menu. The RGBW mode, HSI mode, GEL mode, FX mode and color picker are also available through "Godox Light" APP.

Note: The default saturation of HSI is 100% in light body control.

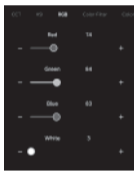

Bluetooth Setting

Bluetooth reset: Long press the /FN button until it flashes blue three times, it will return to the previous effect after successfully reset.

APP download: Scan the QR code to download "Godox Light" APP (both Android and iOS systems are available).

Note: the APP can be used directly on the firstly installed device (smartphone or tablet). When changing to other mobile device, the light shall be reset before the normal usage of APP. The Bluetooth is on by default, and the APP should be V3.0 or above.



Technical Data

Model	C10R
Total Power	Max. 12W
DC Input	5V  3A
AC Input	100V~120V~50/60Hz 130mA/200V~240V~50/60Hz 65mA
Compatible Bulb Holder	E26/E27
CCT (adjustable on APP)	2000K~10000K
Brightness (adjustable on APP)	0%~100%
Average TLCI	≥97
Average CRI	≥96
Illuminance Data(100% brightness and 5500K CCT)	≈470Lux/44fc(1.64ft/0.5m)
	≈130Lux/12fc(3.28ft/1m)
Controlling Method	Bluetooth APP control/light body control
Bluetooth Controlling Distance	Max. 30m
Working Environment Temperature	-10°C~40°C
Dimension	73mm*73mm*136mm
Net Weight	236g

Specifications and data may subject to changes without notice.



Dimming not allowed

"For lamps with a weight significantly higher than that of the lamps for which they are a replacement, attention should be drawn to the fact that the increased weight may reduce the mechanical stability of certain luminaires and lampholders and may impair contact making and lamp retention."

Warning

Operating frequency:2402MHz – 2480MHz
Maximum EIRP Power: 7.31dBm

Declaration of Conformity

GODOX Photo Equipment Co.,Ltd. hereby declares that this equipment are in compliance with the essential requirements and other relevant provisions of Directive 2014/53/EU. In accordance with Article 10(2) and Article 10(10), this product is allowed to be used in all EU member states.
For more information of DoC, Please click this web link:

<https://www.godox.com/eu-declaration-of-conformity>

The device complies with RF specifications when the device used at 0mm from your body.

FCC Statement

This device complies with part 15 of the FCC Rules. Operation is subject to the following two conditions:

- (1) This device may not cause harmful interference, and
 - (2) this device must accept any interference received, including interference that may cause undesired operation.
- Any Changes or modifications not expressly approved by the party responsible for compliance could void the user's authority to operate the equipment.

Note: This equipment has been tested and found to comply with the limits for a Class B digital device, pursuant to part 15 of the FCC Rules. These limits are designed to provide reasonable protection against harmful interference in a residential installation. This equipment generates uses and can radiate radio frequency energy and, if not installed and used in accordance with the instructions, may cause harmful interference to radio communications. However, there is no guarantee that interference will not occur in a particular installation. If this equipment does cause harmful interference to radio or television reception, which can be determined by turning the equipment off and on, the user is encouraged to try to correct the interference by one or more of the following measures:

- Reorient or relocate the receiving antenna.
- Increase the separation between the equipment and receiver.
- Connect the equipment into an outlet on a circuit different from that to which the receiver is connected.
- Consult the dealer or an experienced radio/TV technician for help.

The device has been evaluated to meet general RF exposure requirement.

The device can be used in portable exposure condition without restriction.

产品保修

尊敬的用户,本保修卡是申请保修服务的重要凭证,请您配合销售商填写并妥善保管,谢谢!

产品信息	型号	产品条码
用户信息	姓名	联系电话
	通信地址	
销售商信息	名称	
	联系电话	
	通信地址	
	销售日期	
备注		

注: 此表应由销售商盖章确认。

适用产品

本文件适用于相关《产品保修信息》(见后面说明)所列产品,其他非属此范围的产品或部件(如促销品、赠品及其他出厂后附加的部件等)不在此保修承诺内。

保修期

产品及部件的相应保修期按相关的《产品保修信息》执行。保修期自产品首次购买日起算,购买日以购买产品时保修卡登记日期为准。

如何获得保修服务

您可直接与产品销售商或授权服务机构联系,也可拨打神牛产品售后服务电话,与我们联系,由我们的服务人员为您安排服务。申请保修时,您应提供有效的保修卡作为保修凭证,方可获得保修。如您不能提供有效的保修卡,则在我们确认产品或部件属于保修范围的情况下,也可以为您提供保修,但这不作为我们的义务。

不适用保修的情况

如产品存在下列情况,本文件项下的保证和服务将不适用 ①产品或部件超过相应保修期;②错误或不当使用、维护或保管导致的故障或损坏,如:不当搬运;非按产品合理预期用途使用;不当插拔外接设备;跌落或外力挤压;接触或暴露于不适当温度、溶剂、酸碱、水浸或潮湿环境;③由非神牛授权机构或人员安装、修理、更改、添加或拆卸造成的故障或损坏;④产品或部件原有识别信息被修改变更或删除;⑤无有效保修卡;⑥使用非合法授权、非标准或非公开发行的软件造成的故障或损坏;⑦因不可抗力或意外事件造成的故障或损坏;⑧其他非因产品本身质量问题导致的故障或损坏。遇上述情况,您应向相关责任方寻求解决,神牛对此不承担任何责任。因非在保修期或保修范围内的部件、附件或软件导致产品不能正常使用的,不是保修范围内的故障。产品使用过程中正常的脱色,磨损和消耗,不是保修范围内的故障。

产品保修和服务支持信息

产品的保修期和服务类型按以下《产品保修信息》执行:

产品类别	选件名称	保修期(月)	保修服务类型
部件	电路板	12	客户送修
	电池	3	客户送修
	充电器等带电性能的部件。	12	客户送修
其他	如闪光管、造型灯泡、外壳、保护罩、锁紧装置、包装等。	无	无保修

神牛产品售后服务电话: 0755-29609320-8062

Warranty

Dear customers, as this warranty card is an important certificate to apply for our maintenance service, please fill in the following form in coordination with the seller and safe-keep it. Thank you!

Product Information	Model	Product Code Number
Customer Information	Name	Contact Number
	Address	
Seller Information	Name	
	Contact Number	
	Address	
	Date of Sale	
Note:		

Note: This form shall be sealed by the seller.

Applicable Products

The document applies to the products listed on the Product Maintenance Information (see below for further information). Other products or accessories (e.g. promotional items, giveaways and additional accessories attached, etc.) are not included in this warranty scope.

Warranty Period

The warranty period of products and accessories is implemented according to the relevant Product Maintenance Information. The warranty period is calculated from the day(purchase date) when the product is bought for the first time, And the purchase date is considered as the date registered on the warranty card when buying the product.

How to Get the Maintenance Service

If maintenance service is needed, you can directly contact the product distributor or authorized service institutions. You can also contact the Godox after-sale service call and we will offer you service. When applying for maintenance service, you should provide valid warranty card. If you cannot provide valid warranty card, we may offer you maintenance service once confirmed that the product or accessory is involved in the maintenance scope, but that shall not be considered as our obligation.

Inapplicable Cases

The guarantee and service offered by this document are not applicable in the following cases: ①. The product or accessory has expired its warranty period; ②. Breakage or damage caused by inappropriate usage, maintenance or preservation, such as improper packing, improper usage, improper plugging in/out external equipment, falling off or squeezing by external force, contacting or exposing to the improper temperature, solvent, acid, base, flooding and damp environments, etc; ③. Breakage or damage caused by non-authorized institution or staff in the process of installation, maintenance, alternation, addition and detachment; ④. The original identifying information of product or accessory is modified, alternated, or removed; ⑤. No valid warranty card; ⑥. Breakage or damage caused by using illegally authorized, nonstandard or non-public released software; ⑦. Breakage or damage caused by force majeure or accident; ⑧. Breakage or damage that could not be attributed to the product itself. Once met these situations above, you should seek solutions from the related responsible parties and Godox assumes no responsibility. The damage caused by parts, accessories and software that beyond the warranty period or scope is not included in our maintenance scope. The normal discoloration, abrasion and consumption are not the breakage within the maintenance scope.

Maintenance and Service Support Information

The warranty period and service types of products are implemented according to the following Product Maintenance Information:

Product Type	Name	Maintenance Period(month)	Warranty Service Type
Parts	Circuit Board	12	Customer sends the product to designated site
	Battery	3	Customer sends the product to designated site
	Electrical parts e.g.battery charger, etc.	12	Customer sends the product to designated site
Other Items	Flash tube, modeling lamp, lamp body, lamp cover, locking device, package, etc.	NO	Without warranty

Godox After-sale Service Call 0755-29609320-8062