

合格证  
QC PASS

Godox

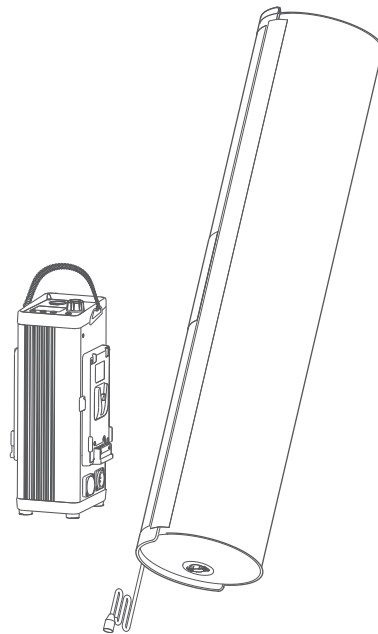

Wechat  
Official Account  
神牛微信公众号

深圳市神牛摄影器材有限公司

地址: 深圳市宝安区福海街道塘尾社区耀川工业区厂房2栋 电话: 0755-29609320(8062)

传真: 0755-25723423 邮箱: godox@godox.com

GODOX Photo Equipment Co.,Ltd.

Add: Building 2, Yaochuan Industrial Zone, Tangwei Community, Fuhai Street, Bao'an District,

Shenzhen 518103, China Tel: +86-755-29609320(8062) Fax: +86-755-25723423

E-mail: godox@godox.com

godox.com

Made in China | 705-AT20BY-01



# KNOWLED AT200 Bi

气柱灯

KNOWLED Air Tube Light

使用手册

Instruction Manual

## 重要的安全说明及注意事项

首先作为最基本原则：本产品为专业灯光布景设备，应由专业灯光师使用或在专业人士指导下使用。使用时必须始终遵循基本的安全预防措施，具体安全预防措施如下：

1. 使用前必须阅读并理解产品说明书。
2. 专业灯具，禁止儿童使用。当儿童靠近时，家长或监护人必须密切监督，以免儿童因碰撞灯具或私用灯具造成人身伤害。
3. 本灯具并非普通照明灯具，不可用于普通照明，任何有过眼部损伤或眼部敏感的人群均应避免使用本灯具。
4. 灯具点亮时，必须小心使用，禁止接触高温部件，如LED灯珠，以免造成灼伤。
5. 灯具点亮时，任何情况下均禁止直视灯珠。应该在专业灯光师指导下使用强光，任何情况下避免长时间处于强光环境，如引起眼睛不适，请及时关闭灯具，暂停使用，请及时就医。
6. 倘灯珠损坏或因热变形，应停止使用，并及时联系制造商、服务代理商或合格的维修人员更换灯珠，以免发生意外。
7. 本产品仅适用于-20°C~40°C工作温度环境下使用。
8. 请勿使用损坏的设备或设备配件，待专业维修人员检查维修，确认设备正常方可使用。
9. 在使用过程中，如果本产品由于跌落、受到挤压或遭受强烈冲击而造成外壳破裂的，请勿继续使用，以免因接触到内部电子元件而受到电击伤害。
10. 如需要延长线，请使用额定电流≥该设备额定电流的延长线。如延长线额定电流小于该设备，可能导致过热。
11. 部分产品电源线较长，请合理放置电源线，使其处于安全位置。避免电源线接触过热物体表面、避免放置不当导致拉扯损坏或绊倒现场人员。请使用原厂原装电源线，如使用非原厂电源线导致产品损坏，概不在原厂维修范围内。
12. 在清洁和维修之前，请务必从电源插座上拔下该设备插头。不使用时，禁止拉扯电源线以将设备插头从电源插座中拔出。正常断电，应是用手抓住该设备插头两端，将插头从电源插座中拔出。此设备需连接到接地插座中。
13. 请勿私自拆卸产品，如产品出现故障，须由本公司或授权的维修人员进行检查维修。
14. 存放本设备之前，请确保设备已完全冷却。存放时，将电源线从设备上拔出。设备应放置于设备便携包内或通风干燥处。
15. 请勿将设备放置在酒精、汽油等易燃易爆挥发的溶剂附近。
16. 本厂不推荐的产品附件，请勿使用，以免导致火灾、触电或人身伤害。
17. 清洁本设备时，请勿用湿布擦拭，请用干布、软布擦拭设备污垢。
18. 设备使用前，请注意将保护罩取下。
19. 本产品已通过ROHS, CE和FCC认证，请参考相关国家标准使用和操作。
20. 安全说明依据本厂严格测试制定，设备设计和规格如有变更，恕不另行通知。客户可以上神牛官网查看最新的电子版说明，了解产品最新资讯。
21. 部分产品内置锂电池。此类产品请使用专用的充电器进行充电，并且按正确的操作说明，在规定的电压、温度范围内使用。

22. 部分产品使用电池供电。此类产品请勿使用说明书中未指定的任何电池、电源或附件。请将电池和其他附件置于儿童及婴幼儿无法触及之处。如果儿童或婴幼儿吞下电池或附件，请立即就医。如果电池漏液、变色、变形、冒烟或发出异味，请立即将其取出。在取出过程中请小心，以免烫伤。如果继续使用，可能会引起火灾、触电或皮肤烫伤。请勿使用任何变形或改造过的电池。请勿拆卸或改造本产品或电池。请勿加热电池或焊接电池。请勿让电池与火或水接触。请勿让电池受到强烈的外力撞击。请勿将电池的正负端错误插入，或将新旧电池或不同类型的电池混合使用。
23. 一年保修期，消耗品电池、适配器、电源线等配件不在此保修范围内。
24. 经发现，擅自检修设备，将取消一年保修期，维修需要收取相关费用。
25. 对于不规范操作引起的机器故障不在保修范围内。

### 保存这些说明

## 前言

感谢您购买神牛产品。

神牛全新推出气柱灯 AT200Bi, 集便携与实用于一体, 拥有大面积柔光、色温范围广、高亮度、移动性强、无极调光、灯体 IP65 级防水、多种无线控制等诸多特性, 适用于短视频拍摄、广告拍摄、电商直播、商业摄影、影视剧拍摄等场景。

## 主要特点:

- 宽广色温, 调节范围: 2700K-8500K
- 4 种调光曲线: 线性、S 型、指数、对数。
- 无极调光, 调节范围: 0%-100%
- 多种控制方式: DMX 512 控台 / 蓝牙 APP/2.4GHz 无线控制。
- 灯体采用 IP65 级防护设计, 防止粉尘进入同时, 支持任何角度泼水。
- 11 类 FX 光效: 闪光灯、雷闪电、多云、坏灯泡、电视机、蜡烛、火、烟花、爆炸、焊接、SOS。

## 警告

- ▲ 大功率气柱灯, 严禁直视光源或照射他人眼睛。
- ▲ 严禁通电时插拔电源线或连接线, 以免造成人身伤害。
- ▲ 本灯具工作时, 请勿遮挡散热口。
- ▲ 请勿让儿童靠近、接触或使用本灯具。
- ▲ 专业灯光设备, 请务必按照使用手册正确操作。
- ▲ **灯体收纳时, 禁止卷曲收纳, 请拆卸气囊后沿中间线折叠收纳。**
- ▲ **控制器不具备防水性能, 使用中请让控制器保持干燥以免造成损坏。**

## 部件名称

### 灯体

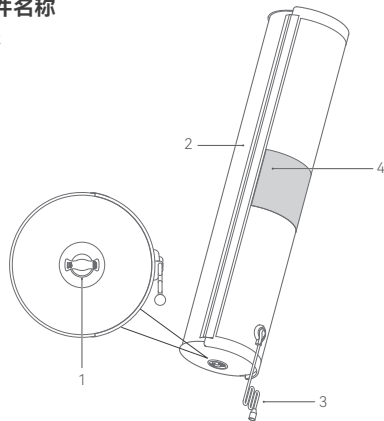

1. 充气口/放气口
2. 气囊
3. 连接线
4. 魔术贴

### 控制器

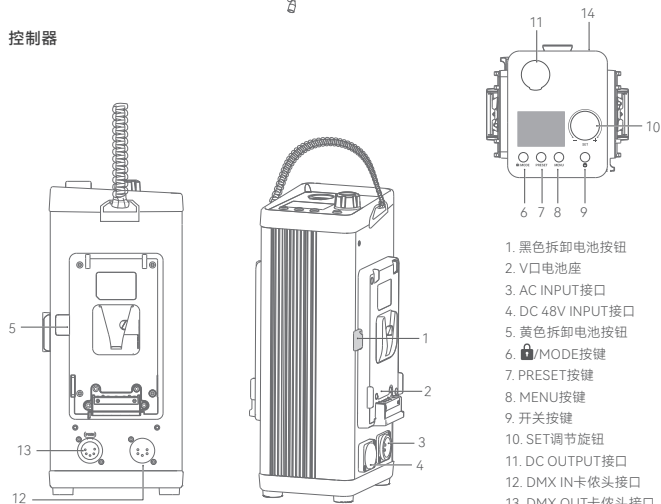

1. 黑色拆卸电池按钮
2. V口电池座
3. AC INPUT接口
4. DC 48V INPUT接口
5. 黄色拆卸电池按钮
6. 锁/MODE按钮
7. PRESET按钮
8. MENU按钮
9. 开关按钮
10. SET调节旋钮
11. DC OUTPUT接口
12. DMX IN卡侬头接口
13. DMX OUT卡侬头接口
14. Type-A接口

## 充气泵

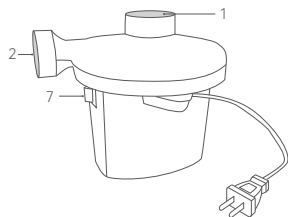

- 1. 放气口
- 2. 充气口
- 3. 气嘴1
- 4. 气嘴2
- 5. 气嘴3
- 6. 转接口
- 7. 开关按键

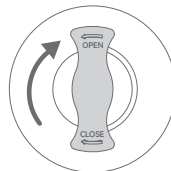
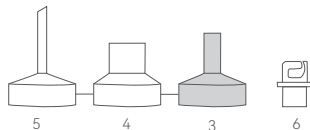

- 5. 充气完毕后，抽出转接口和充气泵，顺时针拧紧充气口。拧紧后，拨动充气泵开关按键至“o”，结束充气。

## AT200Bi充气教程

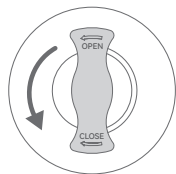

- 1. 逆时针旋转并打开灯体充气口

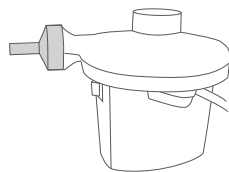

- 2. 将气嘴1插入充气泵充气口

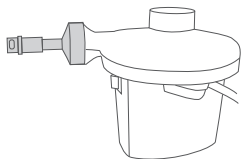

- 3. 将转接口插入气嘴1中。

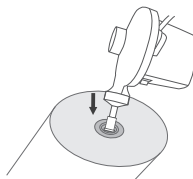

- 4. 将转接口插入充气口，拨动充气泵的开关按键至“-”即可进行充气。

## AT200Bi放气教程

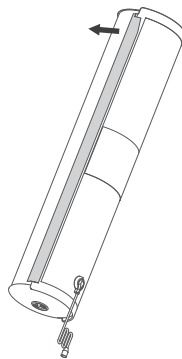

- 1. 先将气囊顺着魔术贴拆卸下来。

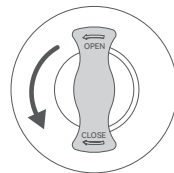

- 2. 逆时针旋转并打开灯体充气口

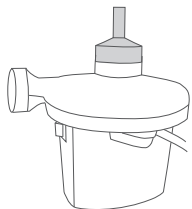

3. 将气嘴1插入充气泵放气口

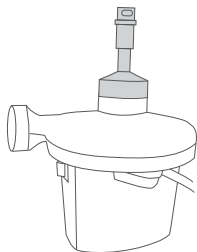

4. 将转接口插入气嘴1中。

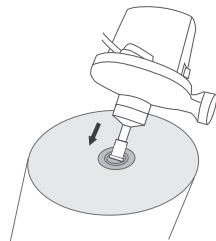

5. 将转接口插入灯体放气口，拨动充气泵的开关按键至“-”即可进行放气。

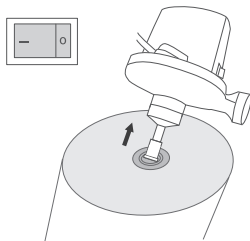

6. 放气完毕后，拨动充气泵的开关按键至“o”。放气结束，抽出转接口和充气泵。

## 修补说明

如不小心划破气柱灯，可使用气柱修补贴进行粘贴修补。

注：粘贴前请将粘贴位置擦拭干净。

## 安装灯体到灯架上

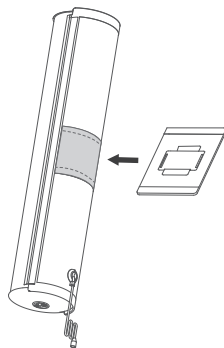

1. 先将固定布粘贴在灯体魔术贴上。

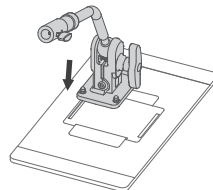

2. 连接支架对准固定布槽位插入，插入后往上提起，将螺栓对着1/4”螺丝口，接着将螺栓往下压的同时顺时针旋紧螺栓。

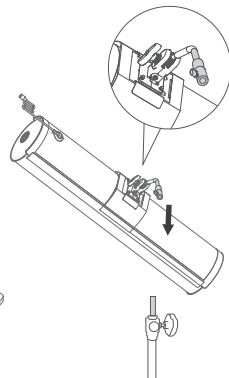

3. 最后将连接支架套筒插入三脚架中，旋转固定旋钮即可完成安装。

## 安装手持把手

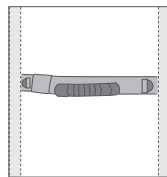

1. 将布质把手竖贴或横贴在灯体魔术贴上，便可进行手持布光。

## 吊装灯体

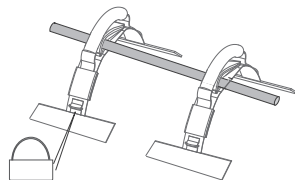

1. 将布质把手竖贴或横贴在灯体魔术贴上，通过把手的吊环可将灯体吊装使用；或通过魔术贴把手吊装在横杠上。

## DMX连接展示

控制器DMX控制台连接操作示意图如下:

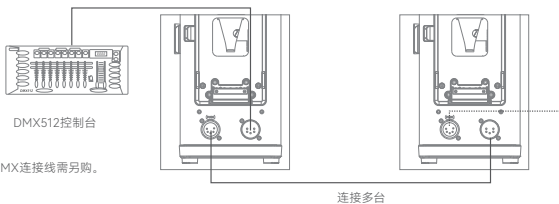

## 物品清单

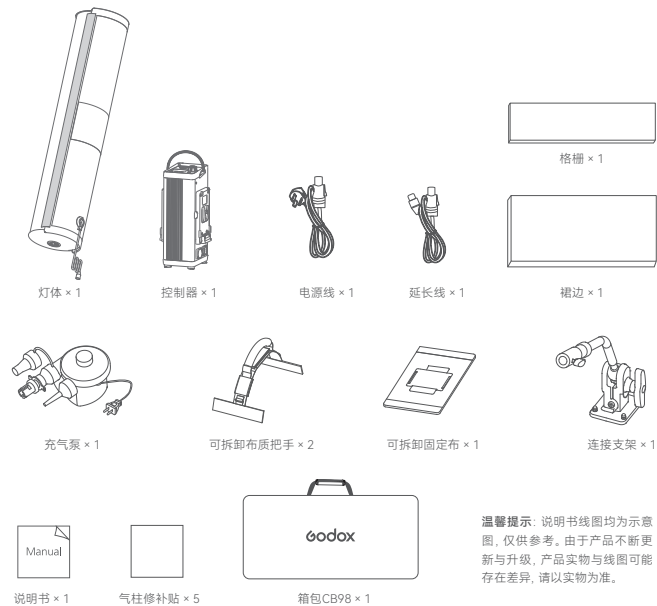

**温馨提示:** 说明书线图均为示意图, 仅供参考。由于产品不断更新与升级, 产品实物与线图可能存在差异, 请以实物为准。

08

## 可另购附件



2.4GHz遥控器RC-A6II



无线DMX发射器Timolink TX



无线DMX接收器Timolink RX



控制器固定件

## 供电方式

### 1. AC供电

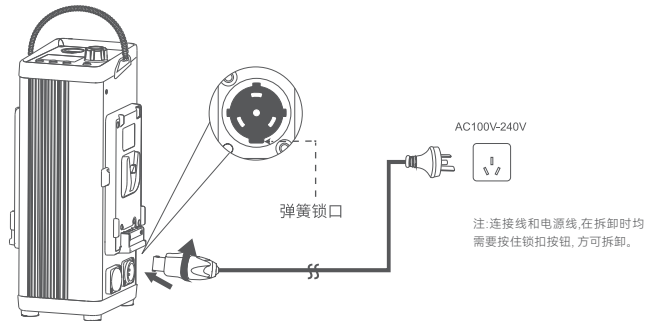

### 2. V口电池供电

注意: 支持使用14.8V或26V的V口电池。只有带黄色拆卸电池按钮一边支持单边供电。双电池供电时, 其中一个电池低电量, 另外一个电池即使满电, 设备依然无法正常工作。电池低电量时, 对应的电池图标呈现闪烁状态。建议使用双电池供电时, 应先检查两个电池是否有足够的电量。

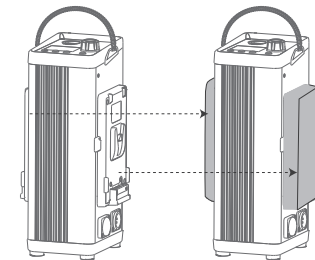

09

## 开关机

接通电源，长按控制器开关按键，实现开机或关机。

开机后，短按开关按键可关闭亮度，亮度为0%，再次短按恢复上一次亮度值。

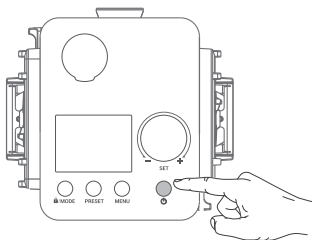

## 色温模式

短按 /MODE 按键切换至色温模式。短按调节旋钮可切换亮度设置 / 色温设置

1. 切换至亮度设置，旋转调节旋钮调节亮度百分比，顺时针旋转一次增加 1 个单元值，逆时针旋转一次减少 1 个单元值；快速旋转，进入快调模式，调节范围为 0%-100%。
2. 切换至色温设置，旋转调节旋钮调节色温值，顺时针旋转一次增加 100 个单元值，逆时针旋转一次减少 100 个单元值；支持快调，调节范围为 2700K-8500K。

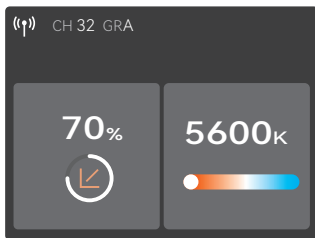

## FX光效模式

短按 /MODE 按键切换至 FX 光效模式。旋转调节旋钮依次选择闪光灯 / 雷闪电 / 多云 / 坏灯泡 / 电视机 / 蜡烛 / 火 / 烟花 / 爆炸 / 焊接 / SOS 场景等 11 类光效。

选中所需光效，短按调节旋钮进入光效设置界面，光效设置完毕，短按 /MODE 按键返回上一级。



## 1. 闪光灯光效

进入闪光灯光效，旋转调节旋钮选择开关、亮度百分比、自动、手动、色温、速度、模式等选项。短按调节旋钮选中选项，旋转调节旋钮可调节选项（自动、手动等选项除外）。

亮度调节范围：0%-100%

色温：2700K-8500K

速度：1-100

模式：模拟闪光灯光效/模拟镁光灯光效

注：选中手动，通过短按一次调节旋钮触发一次闪光灯光效。

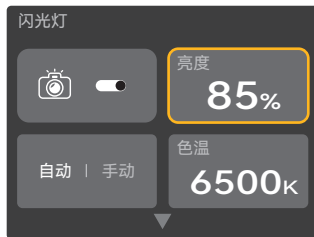

## 2. 雷闪电光效

进入雷闪电光效，旋转调节旋钮选择开关、亮度百分比、自动、手动、色温、次数、频率等选项。短按调节旋钮选中选项后，旋转调节旋钮可调节选项参数（自动、手动等选项除外）。

亮度调节范围：0%-100%

色温：2700K-8500K

次数：随机/1-10

频率：随机/2-20

注：选中手动，通过短按一次调节旋钮触发一次雷闪电光效。



## 3. 多云光效

进入多云光效，旋转调节旋钮选择开关、亮度百分比、亮暗比例、速度等选项。短按调节旋钮选中选项后，旋转调节旋钮可调节选项参数。

亮度调节范围：0%-100%

亮暗比例：30%-90%

速度：随机/1-100

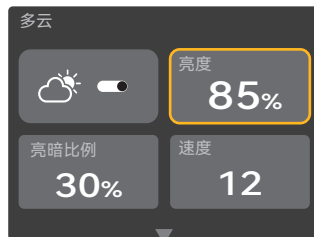

#### 4. 坏灯泡光效

进入坏灯泡光效，旋转调节旋钮选择开关、亮度百分比、速度、色温等选项。短按调节旋钮选中选项后，旋转调节旋钮可调节选项参数。设置完毕，短按  /MODE 按键返回上一级。

亮度调节范围：0%-100%

速度：1-100

色温：2700K-8500K



#### 5. 电视机光效

进入电视机光效，旋转调节旋钮选择开关、亮度百分比、速度等选项。短按调节旋钮选中选项后，旋转调节旋钮可调节选项参数。

亮度调节范围：0%-100%

速度：1-100

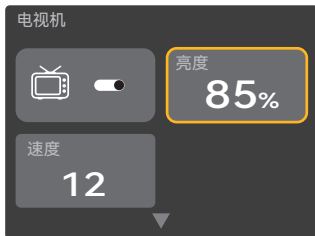

#### 6. 蜡烛光效

进入蜡烛光效，旋转调节旋钮选择开关、亮度百分比、速度等选项。短按调节旋钮选中选项后，旋转调节旋钮可调节选项参数。

亮度调节范围：0%-100%

速度：1-100

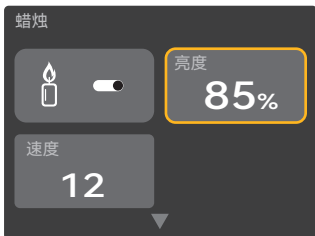

#### 7. 火光效

进入火光效，旋转调节旋钮选择开关、亮度百分比、速度等选项。短按调节旋钮选中选项后，旋转调节旋钮可调节选项参数。

亮度调节范围：0%-100%

速度：1-100

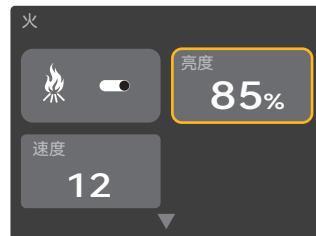

#### 8. 烟花光效

进入烟花光效，旋转调节旋钮选择开关、亮度百分比、速度、余烬等选项。短按调节旋钮选中选项后，旋转调节旋钮可调节选项参数。

亮度调节范围：0%-100%

速度：1-100

余烬：1-100



#### 9. 爆炸光效

进入爆炸光效，旋转调节旋钮选择开关、亮度百分比、自动、手动、色温、速度、余烬等选项。短按调节旋钮选中选项后，旋转调节旋钮可调节选项参数（自动、手动等选项除外）。

亮度调节范围：0%-100%

色温：2700K-8500K

速度：1-100

余烬：1-100

注：选中手动，通过短按一次调节旋钮触发一次爆炸光效。





## 10. 焊接光效

进入焊接光效，旋转调节旋钮选择开关、亮度百分比、速度、色温等选项。短按调节旋钮选中选项后，旋转调节旋钮可调节选项参数。

亮度调节范围: 0%-100%

速度: 1-100

色温: 2700K-8500K

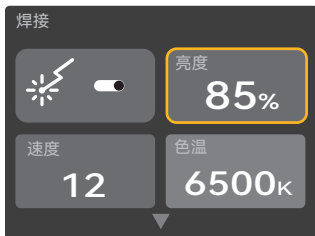

## 11. SOS光效

进入 SOS 光效，旋转调节旋钮选择开关、亮度百分比、色温等选项。短按调节旋钮选中选项后，旋转调节旋钮可调节选项参数。

亮度调节范围: 0%-100%

色温: 2700K-8500K

注: 使用FX场景光效时，调光曲线默认为线性

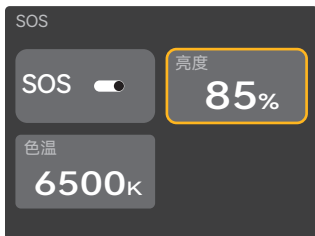

## 菜单设置

短按 MENU 按键进入菜单设置，旋转调节旋钮选择 DMX、蓝牙、无线、调光曲线、快速开机、屏幕设置、语言、系统升级、恢复出厂、灯具信息。



### 1. DMX

短按调节旋钮进入DMX设置界面。旋转调节旋钮选择地址/DMX模式/增强通道/DMX丢失状态/RDM状态。短按调节旋钮进入选项设置，通过旋转调节旋钮完成选项设置。选项设置完毕，短按MENU按键返回上一级。



一级选项	二级选项	说明
地址	1-512	起始地址
DMX模式	CCT 8 bit	8位CCT模式
	FX 8 bit	8位FX模式
	ULTIMATE 8 bit	8位 ULTIMATE模式
增强通道	开启	开启增强通道信号
	关闭	关闭增强通道信号
DMX丢失状态	保持最后状态	失去DMX控制信号后, 在关机或再次接收有效DMX控制信号前, 灯具保持最后一次接收的DMX控制信号状态
	直接关闭	灯具直接熄灭
	保持最后状态2min	失去DMX控制信号后, 灯具保持最后一次接收的DMX控制信号状态, 2分钟后灯具熄灭。注: 如2分钟内接收到有效DMX控制信号, 则使用新的DMX控制信号。
RDM状态	开启	开启RDM
	关闭	关闭RDM

DMX实用表

CCT 8 bit模式						
DMX 通道	功能	参数名	DMX值 8 bit		实际参数值 8bit	
			起始值	结束值	起始值	结束值
1	CCT	亮度	0	255	0.0%	100.0%
2		色温	0	255	2700K	8500K

FX 8 bit 模式							
DMX 通道	功能	参数名	DMX值 8 Bit		实际参数值 8Bit		
1	FX光效	光效类型	亮度	0	255	0.0%	100.0%
			0	9	光效关闭		
			10	19	闪光灯		
			20	29	雷闪电		
			30	39	多云		
			40	49	坏灯泡		
			50	59	TV		
			60	69	蜡烛		
			70	79	火		
			80	89	烟花		
			90	99	爆炸		
			100	109	焊接		
			110	119	SOS		
120	255	预留					
3	闪光灯	色温	0	255	2700K	8500K	
4		速度	0	255	1	100	
5		模式	0	255	0闪光灯	1镁光灯	
3	雷闪电	色温	0	255	2700K	8500K	
4		次数	0	255	0(随机)	10	
5		频率	0	255	0(随机)	20	
3	多云	亮暗比例	0	255	30%	90%	
4		速度	0	255	0(随机)	100	
3	坏灯泡	色温	0	255	2700K	8500K	
4		速度	0	255	1	100	
3	TV	速度	0	255	1	100	
3	蜡烛	速度	0	255	1	100	
3	火	速度	0	255	1	100	
3		速度	0	255	1	100	
4	烟花	余烬	0	255	1	100	
3		色温	0	255	2700K	8500K	
4		速度	0	255	1	100	
5	爆炸	余烬	0	255	1	100	
3		色温	0	255	2700K	8500K	
4		速度	0	255	1	100	
3	焊接	色温	0	255	2700K	8500K	
4		速度	0	255	1	100	
3	SOS	色温	0	255	2700K	8500K	

ULTIMATE 8 bit 模式						
DMX 通道	功能	参数名	DMX值 8 Bit		实际参数值 8Bit	
1		亮度	0	255	0.0%	100.0%
2		模式选择	0	9	CCT模式	
			10	19	FX模式	
			20	255	预留	
3		颜色参数1				

ULTIMATE 8 bit模式中CCT 参数						
DMX 通道	功能	参数名	DMX值 8 Bit		实际参数值 8Bit	
3	CCT	色温	0	255	2700K	8500K

ULTIMATE 8 bit 模式中FX参数						
DMX 通道	功能	参数名	DMX值 8 Bit		实际参数值 8Bit	
3	FX	光效类型	0	9	光效关闭	
			10	19	闪光灯	
			20	29	雷闪电	
			30	39	多云	
			40	49	坏灯泡	
			50	59	TV	
			60	69	蜡烛	
			70	79	火	
			80	89	烟花	
			90	99	爆炸	
			100	109	焊接	
			110	119	SOS	
			120	255	预留	
4	闪光灯	色温	0	255	2700K	8500K
5		速度	0	255	1	100
6		模式	0	255	0闪光灯	1镁光灯
4	雷闪电	色温	0	255	2700K	8500K
5		次数	0	255	0(随机)	10
6		频率	0	255	0(随机)	20
4	多云	亮暗比例	0	255	30%	90%
5		速度	0	255	0(随机)	100
4	坏灯泡	色温	0	255	2700K	8500K
5		速度	0	255	1	100
4	TV	速度	0	255	1	100
4	蜡烛	速度	0	255	1	100
4	烟花	速度	0	255	1	100
5		余烬	0	255	1	100
4	爆炸	色温	0	255	2700K	8500K
5		速度	0	255	1	100
6		余烬	0	255	1	100
4	焊接	色温	0	255	2700K	8500K
5		速度	0	255	1	100
4	SOS	色温	0	255	2700K	8500K

## 2. 蓝牙

短按调节旋钮进入蓝牙设置界面。旋转调节旋钮选择蓝牙开关/蓝牙复位，短按调节旋钮进入设置，通过旋转调节旋钮完成设置。设置完毕，短按MENU按键返回上一级。

蓝牙MAC码：位于界面左下角，方便查找灯具蓝牙。

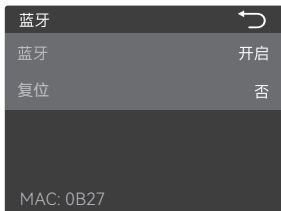

扫描二维码即可下载“Godox Light”手机APP（安卓和苹果系统都可以使用）。

注：

1. 首个移动设备（手机或平板电脑）可直接使用APP操控灯体，更换其他移动设备时，灯体需进行蓝牙重置方可正常使用APP。

2. APP需升级至V3.0以上版本。

## 3. 无线

短按调节旋钮进入无线设置界面。旋转调节旋钮选择无线/组别/通道/识别号。短按调节旋钮进入选项设置，通过旋转调节旋钮完成选项设置。选项设置完毕，短按MENU按键返回上一级。

无线：开启2.4G无线接收/关闭2.4G无线接收

组别：0-9/A-F

通道：01-32

识别号：关闭/01-99



注：使用遥控器RC-A6II（另购）或遥控器RC-R9II（另购）时，遥控器组别、通道和ID号需和灯体AT200B组别、通道和识别号（ID号）相同。

## 4. 调光曲线

短按调节旋钮进入调光曲线设置界面。旋转调节旋钮选择线性、S型、指数、对数。选择完毕，短按调节旋钮/短按MENU按键返回上一级。



## 5. 快速开机

短按调节旋钮进入快速开机设置界面。旋转调节旋钮选择开启/关闭。选择完毕，短按MENU按键返回上一级。

注：使用快速开机功能，接通电源后，控制盒自动启动开机。



## 6. 屏幕设置

短按调节旋钮进入屏幕设置界面。旋转调节旋钮设置屏幕亮度值，调节范围为20%-100%。设置完毕，短按MENU按键返回上一级。

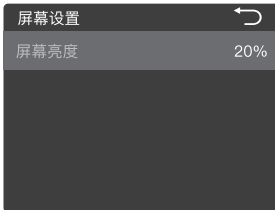

## 7. 语言

短按调节旋钮进入语言设置界面。旋转调节旋钮选择简体中文/English。短按调节旋钮完成设置。设置完毕，短按MENU按键返回上一级。



## 8. 系统升级

短按调节旋钮进入系统升级界面，在此界面可查看升级固件提示。查看完毕，短按MENU按键返回上一级。

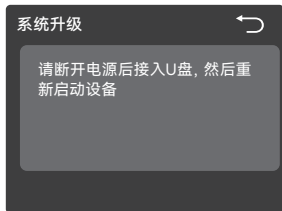

### 升级详情

1. 在官网 (<https://www.godox.com.cn/firmware-continuous-light>) 下载新固件到U盘上。
2. 在关机的状态下，将存有新固件的U盘插入Type-A USB端口。
3. 开机后AT200Bi柔性LED灯自动进入升级界面。
4. 升级完毕自动跳回主界面。

### 注:

1. 必须在官网下载新固件，存放在U盘根目录里，而且仅有一个BIN文件。
2. Type-A USB端口支持供电，输出电压电流5V /1A，请勿接入大功率USB设备

## 9. 恢复出厂

短按调节旋钮进入恢复出厂设置界面。旋转调节旋钮选择确定/取消，短按调节旋钮选择相关选项。选择恢复出厂后，界面自动跳转到语言设置。



## 10. 灯具信息

短按调节旋钮进入灯具信息界面，在此界面可查看灯具型号、UID号、固件版本等信息。查看完毕，短按MENU按键返回上一级。



## 锁定设置

长按  /MODE按键，屏幕出现  表示当前界面被锁定；再次长按  /MODE按键便可解锁。

注：此锁定功能仅锁定控制器操控面板，其他操作方式仍可正常操作。

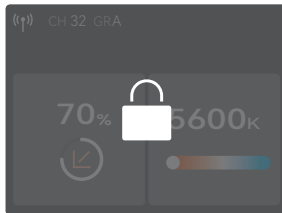

## 预存设置

短按PRESET按键进入预存灯具光效界面。旋转调节旋钮选择1-10组预设，短按调节旋钮进入预设组设置，通过旋转调节旋钮可选应用/保存/取消，最后短按调节旋钮完成设置并自动返回上一级。设置完毕，短按PRESET按键退出预存设置。

注：某组如未预设过光效，界面不显示应用选项。

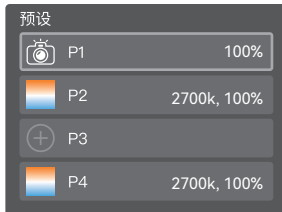

## 维护保养

一年保修期，消耗品电池，适配器，电源线等配件不在此保修范围内。

经发现，擅自检修此LED灯，将取消LED灯一年保修期，维修需要收取相关费用。

对于不规范操作引起的机器故障不在保修范围内。

所有维修一概由本厂指定的可供原配件的维修部负责。

## 照度数据

色温	照度单位	1m	2m	3m
2800K	lux	≈1720	≈549	≈267
	fc	≈160	≈51	≈24.8
3200K	lux	≈1860	≈599	≈290
	fc	≈173	≈55.6	≈27
4300K	lux	≈2160	≈692	≈343
	fc	≈200	≈64.3	≈31.9
5600K	lux	≈2230	≈712	≈353
	fc	≈207	≈66.2	≈32.8
6500K	lux	≈2210	≈704	≈349
	fc	≈205	≈65.4	≈32.4
7500K	lux	≈2150	≈685	≈339
	fc	≈200	≈63.6	≈31.5
8500K	lux	≈2050	≈654	≈325
	fc	≈191	≈60.7	≈30.2

以上数据为平均值，非绝对值，以上测试皆在灯体100%亮度下进行。

## 规格参数

型号	AT200Bi
供电	100V-240V-50/60Hz 2.1A
最大功率	≈210W
色温	2700-8500K
调光范围	0%-100%
调光类型	线性/S型/指数/对数
FX场景光效	11类
CRI	平均≈96
TLCI	平均≈96
灯体防水等级	IP65
控制方式	DMX 512控制台控制，支持RDM协议/2.4无线控制/蓝牙APP控制
蓝牙控制距离	最远30m
2.4G控制距离	最远60m
Type-A USB接口	固件升级/5V=1A供电
尺寸	灯体: 280mm*267mm*1226mm /11*11*48"(带气囊且处于充气状态, 不包含连接线) 控制器: 124mm*132mm*270mm/4.8*5*10.6"
净重≈	灯体: 2.15kg (包含气囊) 控制器: 2.8kg

设计和规格如有变更，恕不另行通知。

本设备包含型号核准代码为: CMIITID: 2020DP13510, 为该产品的无线电发射模块。

## Important Safety Instructions and Precautions

**First of all, as the most basic principle: This product is a professional lighting set equipment and should be used by professional lighting engineers or under the guidance of professionals. Basic safety attentions must always be followed during use, as follows:**

1. Before use, please read and understand these instructions and attentions.
2. Professional lighting is prohibited for children. When children are near, parents or accompanying persons must supervise closely to prevent children from personal injury due to collision with lamps or private use of lamps.
3. This lighting product is not ordinary lighting product and cannot be used for general lighting. Anyone who has suffered eye damage or has sensitive eyes should avoid using this product.
4. When the lamp is on, it must be used with care. Do not touch high-temperature parts, such as LED lamp beads, to avoid burns.
5. When the lamp is on, it is forbidden to look directly at the lamp beads under any circumstances. Strong light should be used under the guidance of professional lighting engineers. Avoid prolonged exposure to strong light under any circumstances. If eye discomfort, please turn off the lamp in time, suspend use, and see a doctor immediately.
6. If the lamp bead is damaged or deformed by heat, stop using this equipment, and contact the manufacturer, service agent or qualified maintenance personnel to replace the lamp bead in time to avoid accidents.
7. This product is only suitable for use in -20°C to 40°C operating environment and normal humidity environment.
8. Do not use damaged equipment or accessories, and wait for professional maintenance personnel to check and repair to confirm being normal before use.
9. During using, if the casing of this product is broken due to being dropped, squeezed or subjected to strong impact, please do not use it, so as to avoid electric shock injury due to contact with internal electronic components.
10. If an extension cord is required, please use an extension cord with a current rating greater than or equal to that of the equipment. If an extension cord is rated less than the equipment, overheating may result.
11. Some products have long power cords, please place the power cords properly and keep them in a safe place. Avoid contacting the power cord with overheating surfaces, avoid improper placement that could cause pulling damage, or trip on-site personnel. Please use the certified power cord from the original manufacturer. If the product is damaged by using a non-certified power cord, it will not be repaired by our factory.
12. Be sure to unplug equipment from the power outlet before cleaning and repairing. When not in use, do not pull the power cord to unplug the equipment. For normal power-off, please hold both ends of the plug of the equipment with your hands and pull the plug out of power outlet. This equipment needs to be connected to a grounded outlet.
13. Do not disassemble the product without permission. If the product fails, it must be checked and repaired by authorized maintenance personnel.

14. Before storing, make sure that the equipment has cooled down completely. For storage, unplug the power cord from the equipment. The equipment should be placed in the carrying case or in a ventilated dry place.
15. Do not place equipment near flammable and volatile solvents such as alcohol and gasoline.
16. Do not use accessories that are not recommended by our factory to avoid fire, electric shock or personal injury.
17. When cleaning, do not wipe it with a damp cloth, please use a dry cloth or a soft cloth to wipe the dirt of the equipment.
18. Please take off the protective cover before using.
19. This product complies with ROHS, CE and FCC certification, please refer to the relevant national standards for use and operation.
20. The safety instructions are formulated according to the strict testing of the factory, and the design and specifications of the equipment are subject to change without prior notice. For latest product information, please check the GODOX website and view latest electronic instruction.
21. Some products have built-in lithium batteries. Please use specified chargers, and use them within a proper range of the specified voltage and temperature according to the correct operating instructions.
22. Some products are battery powered. Do not use any batteries, power sources or accessories not specified in the instructions for such products. Keep batteries and other accessories out of the reach of children and infants. In the instance that a child or infant swallows a battery or accessory, immediate emergency medical attention is required. If the battery leaks, becomes discolored, deformed, emits smoke, or emits an abnormal odor, remove it immediately. Be careful during removal to avoid burns. Continued use could result in fire, electric shock, or burns. Do not use any deformed or modified batteries. Do not disassemble or modify this product or battery. Do not heat or solder the battery. Keep the battery away from fire or water. Do not incorrectly insert the positive and negative ends of batteries, or mix old and new batteries or batteries of different types together.
23. One-year warranty period, accessories such as consumable batteries, adapters, power cords, etc. are not covered by this warranty.
24. If it is found that the equipment is repaired without authorization, the one-year warranty period will be cancelled and relevant fees will be charged for maintenance.
25. Machine failures caused by non-standard operation are not covered by the warranty.

**keep these instructions!**

## Foreword

Thank you for purchasing a Godox product!

Introducing the brand new AT200Bi from Godox! Our latest innovation combines portability and practicality, featuring a large area soft lighting, wide CCT range, high brightness, and exceptional mobility. It is the ultimate lighting solution for any situation. Plus, with features such as stepless dimming, IP65 waterproof rating, and various wireless control options, you can take your lighting game to the next level. This versatile lighting solution is perfect for short video shoots, advertising, e-commerce livestreaming, commercial photography, and film and TV production.

## Main Features

- Wide CCT range adjustable from 2700K to 8500K.
- Four dimming curves: linear, s-curve, exponential, logarithmic.
- Stepless brightness adjustment from 0% to 100%.
- Various Controlling methods: DMX 512 controller/ APP control via Bluetooth/2.4GHz remote control.
- Protection grade of IP65 keeps the light body from dust and water.
- 11 FX modes: flash, lightning, cloudy, broken bulb, TV, candle, fire, firework, explosion, welding, SOS.

## Warning

- ▲ Do not look directly at the LED light or illuminate at others' eyes.
  - ▲ Do not plug or unplug the power cable or connecting cable when the power is turned on, otherwise personal injuries may occur.
  - ▲ Do not cover the heat dissipation vent in working status.
  - ▲ Keep out of reach of children.
  - ▲ Please make sure to follow the instruction manual and correctly use this professional lighting device.
- ▲ **During light body storage, do not fold or roll it up. Please detach the airbag and fold it along the center line for storage.**
- ▲ **The controller is not waterproof, please keep it dry in using.**

## Name of Parts

### Light Body

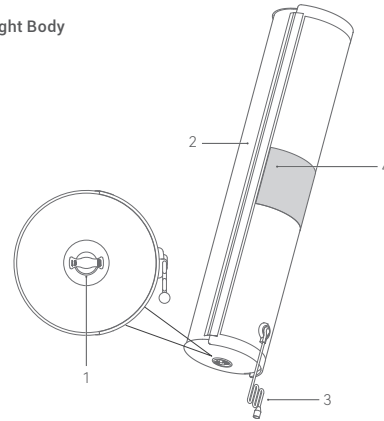

1. Air Intake Valve/Bleeder Valve
2. Airbag
3. Connection Cable
4. Velcro

### Controller

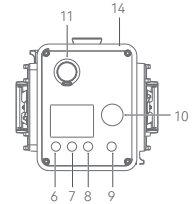
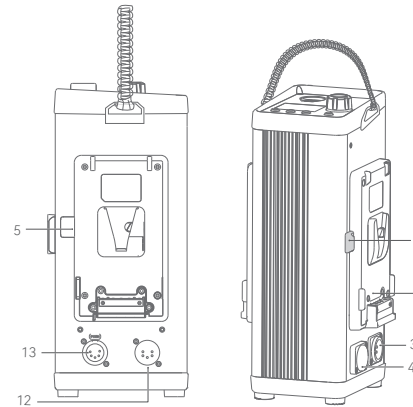

1. Black Battery Remove Button
2. V-mount Battery Holder
3. AC INPUT Port
4. DC 48V INPUT Port
5. Yellow Battery Remove Button
6. Lock /MODE Button
7. PRESET Button
8. MENU Button
9. Power Switch Button
10. SET Select Dial
11. DC OUTPUT Port
12. DMX IN XLR Port
13. DMX OUT XLR Port
14. Type-A Port



## Inflator

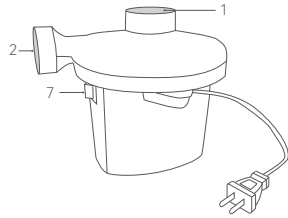

1. Bleeder Valve
2. Air Intake Valve
3. Nozzle1
4. Nozzle2
5. Nozzle3
6. Adapter
7. Power Switch

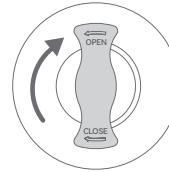
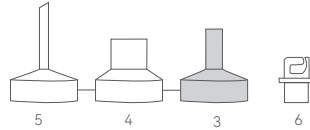

4. After inflation, pull out the adapter and inflator; turn the air intake valve clockwise to ensure air tightness; after tightening the air intake valve, turn the inflator power switch button to "o" to end the inflation process.

## AT200Bi Inflation Guide

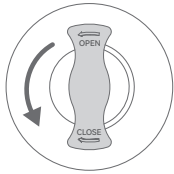

1. Rotate counterclockwise and open the air intake valve on the light body.

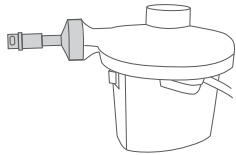

3. Insert the adapter into nozzle1.

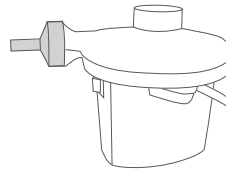

2. Insert nozzle1 into the air intake valve.

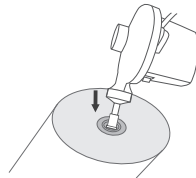

4. Insert the adapter into the air intake valve, turn on the inflator and press the "+" button to start inflating.

## AT200Bi Deflation Guide

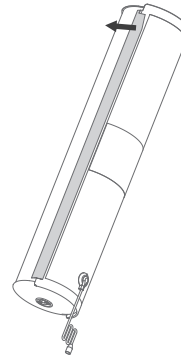

1. Detach the airbag along the velcro

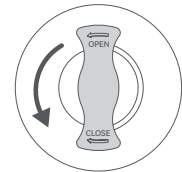

2. Rotate counterclockwise and open the air intake valve on the light body.

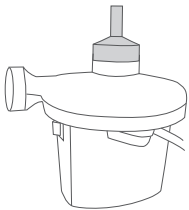

3. Insert nozzle<sup>1</sup> into the bleeder valve of the inflator.

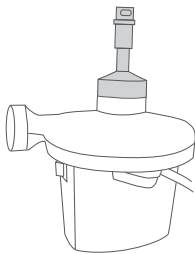

4. Insert the adapter into nozzle<sup>1</sup> of the inflator.

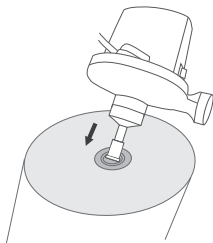

5. Insert the adapter into the bleeder valve of the light body, turn on the inflator and press the '-' button to start deflating.

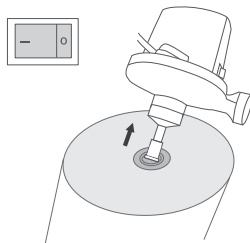

6. Once deflation is complete, turn the inflator off by pressing the 'o' button, remove the adapter and the inflator.

## Repair Instructions

If the air tube light is accidentally scratched or damaged, the air tube light repair patch can be used for adhesive repair.

Note: Please clean the repair area before applying the patch.

## Mount the Light Body on the Light Stand

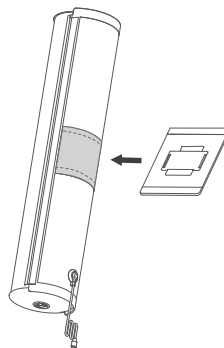

1. Stick the velcro hook fastener to the velcro loop on the light body.

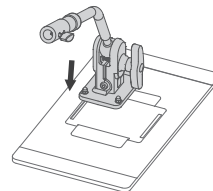

2. Align the connecting holder with the hook fastener slot and insert it, lifting it up afterwards. Align the bolt with the 1/4" screw hole and while pushing down, turn the bolt clockwise to tighten it.

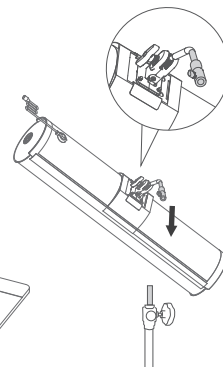

3. Insert the sleeve of the connecting holder into the tripod and turn the locking knob to complete the installation.

## Mount the Handle

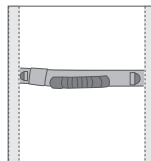

1. Attach the fabric handle vertically or horizontally to the velcro on the light body to use it for handheld light diffusion.

## Lift the Light Body

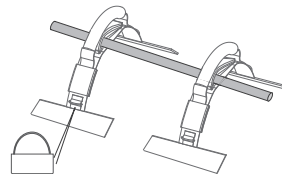

1. Attach the fabric handle vertically or horizontally to the velcro on the light body. The handle's hang loop can be used to lift the light body for various uses; alternatively, you can lift the light body onto the crossbar using the Velcro handle.

## Connect to DMX Controller

The connection operation diagram of DMX controller is as follows:

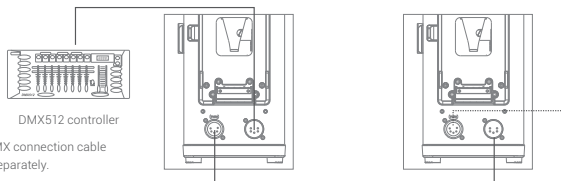

DMX512 controller

Note: DMX connection cable is sold separately.

Multiple connections

## What's Inside

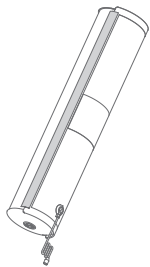

Light Body × 1



Controller × 1



Power Cord × 1



Extension Cable × 1



Grid × 1



Skirt × 1

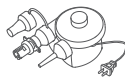

Inflator × 1



Fabric Handle × 2



Velcro Hook Fastener × 1



Connecting Holder × 1



Instruction Manual × 1



Air Tube Light Repair Patch × 5



Carry Bag CB98 × 1

**Note:** Due to continuous updates and upgrades of the products, there may be differences between the actual products and the pictures. Therefore, the pictures are for reference only, products to prevail in kind.

## Separately Sold Accessories



2.4GHz Remote Control RC-A6II



Wireless DMX Transmitter Timolink TX



Wireless DMX Receiver Timolink RX



Controller Fixing Device

## Power Supply

### 1.AC Power Supply

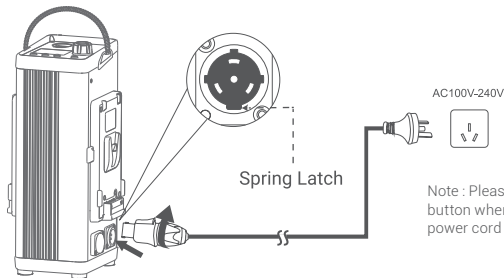

AC100V-240V

Spring Latch

Note: Please press the latch button when disassembling the power cord and connection cable.

### 2.V-mount battery power supply

Note: The light can be supplied by 14.8V or 26V V-mount battery. Only the side with yellow battery removal button supports one-sided charging. When it is powered by two batteries and one battery is running low on power, the device still can't work normally even if the other one is fully charged. The corresponding battery icon will blink in low battery mode. It is recommended to check whether both batteries have sufficient power when using two batteries.

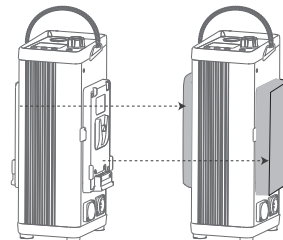

## Power Switch

Long press the power switch button on the controller after connecting to power source to turn the unit on or off.

Short pressing the power switch button in the power on state can reduce the brightness to 0%, short press again to restore the previous brightness.

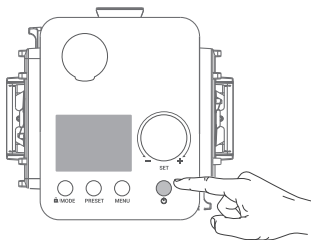

## CCT Mode

Short press the /MODE button to switch to CCT mode, short press the select dial to toggle between brightness setting and CCT setting.

1. In the brightness setting interface, turn the select dial to adjust the brightness ratio from 0% to 100%. Turning the select dial clockwise once will increase the value by 1 unit, while turning it counterclockwise will decrease the value by 1 unit. Quick adjustment is also available by turning the select dial quickly.

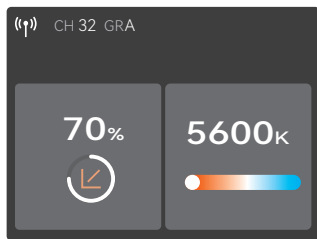

2. In the color temperature setting interface, turn the select dial to adjust the color temperature from 2700K to 8500K. Turning the select dial clockwise once will increase the value by 100 units, while turning it counterclockwise once will decrease the value by 100 units.

## FX Mode

Short press the /MODE button to switch to FX mode, turn the select dial to switch among the following 11 effects: flash, lightning, cloudy, broken bulb, TV, candle, fire, firework, explosion, welding, SOS.

Select the desired effect and short press the select dial to enter the effect setting interface, then short press the /MODE button to return to previous interface.

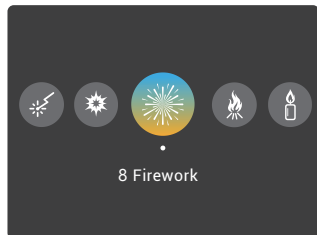

## 1. Flash Effect

In the flash effect setting interface, turn the select dial to select options among switch, dim, auto, manual, CCT, speed, mode, etc. Short press the select dial to select the desired option then rotate to adjust settings (except for the auto and manual options).

DIM: 0%-100%

CCT: 2700K-8500K

Speed: 1-100

Mode: Camera Flash/Flash Bulb

Note: Select manual, then the flash effect can be triggered once by short pressing the select dial once.

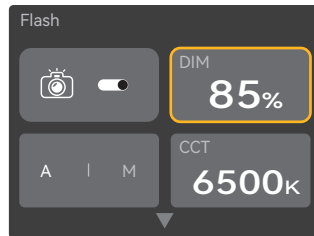

## 2. Lightning Effect

In the lightning effect setting interface, turn the select dial to select options among switch, dim, auto, manual, CCT, times, frequency, etc. Short press the select dial to select the desired option then rotate to adjust settings (except for the auto and manual options).

DIM: 0%-100%

CCT: 2700K-8500K

Times: Random/1-10

Frequency: Random /2-20

Note: Select manual, then the lightning effect can be triggered once by short pressing the select dial once.

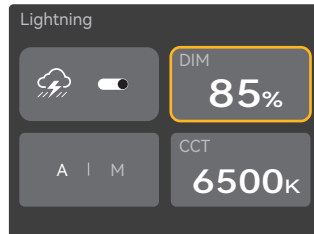

## 3. Cloudy Effect

In the cloudy effect setting interface, turn the select dial to select options among switch, dim, ratio, speed, etc. Short press the select dial to select the desired option then rotate to adjust settings.

DIM: 0%-100%

Ratio: 30%-90%

Speed: Random/1-100

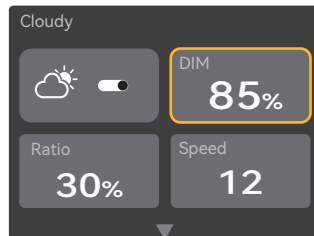

#### 4. Broken Bulb Effect

In the broken bulb effect setting interface, turn the select dial to select options among switch, dim, speed, CCT, etc. Short press the select dial to select the desired option then rotate to adjust settings.

DIM: 0%-100%

Speed: 1-100

CCT: 2700K-8500K

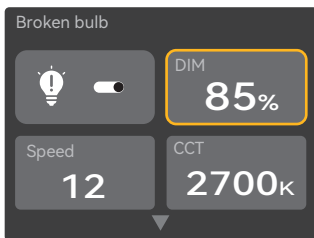

#### 5. TV Effect

In the TV effect setting interface, turn the select dial to select options among switch, dim, speed, etc. Short press the select dial to select the desired option then rotate to adjust settings.

DIM: 0%-100%

Speed: 1-100

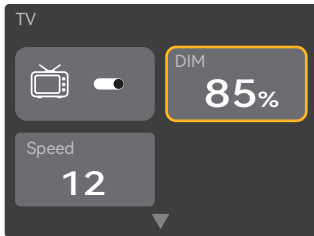

#### 6. Candle Effect

In the candle effect setting interface, turn the select dial to select options among switch, dim, speed, etc. Short press the select dial to select the desired option then rotate to adjust settings.

DIM: 0%-100%

Speed: 1-100

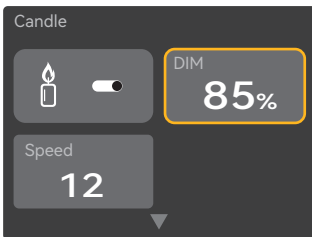

#### 7. Fire Effect

In the fire effect setting interface, turn the select dial to select options among switch, dim, speed, etc. Short press the select dial to select the desired option then rotate to adjust settings.

DIM: 0%-100%

Speed: 1-100

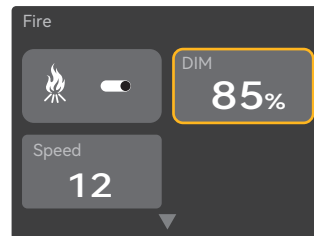

#### 8. Firework Effect

In the firework effect setting interface, turn the select dial to select options among switch, dim, speed, embers, etc. Short press the select dial to select the desired option then rotate to adjust settings.

DIM: 0%-100%

Speed: 1-100

Embers: 1-100

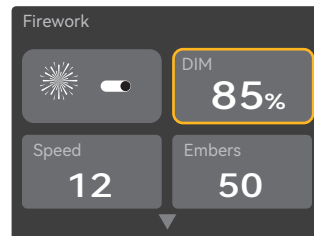

#### 9. Explosion Effect

In the explosion effect setting interface, turn the select dial to select options among switch, dim, auto, manual, CCT, speed, embers, etc. Short press the select dial to select the desired option then rotate to adjust settings (except for the auto and manual options).

DIM: 0%-100%

CCT: 2700K-8500K

Speed: 1-100

Embers: 1-100

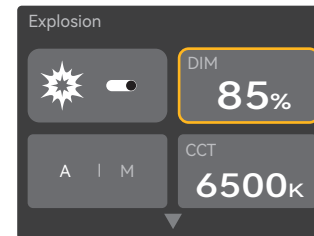

Note: Select manual, then the explosion effect can be triggered once by short pressing the select dial once.

## 10. Welding Effect

In the welding effect setting interface, turn the select dial to select options among switch, dim, speed, CCT, etc. Short press the select dial to select the desired option then rotate to adjust settings.

DIM: 0%-100%

Speed: 1-100

CCT: 2700K-8500K

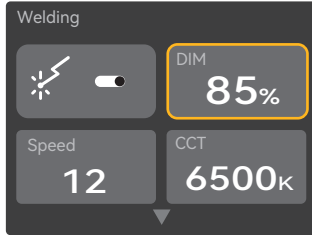

## 11. SOS Effect

In the SOS effect setting interface, turn the select dial to select options among switch, dim, CCT, etc. Short press the select dial to select the desired option then rotate to adjust settings.

DIM: 0%-100%

CCT: 2700K-8500K

Note: The dimming curve is linear by default in FX mode.

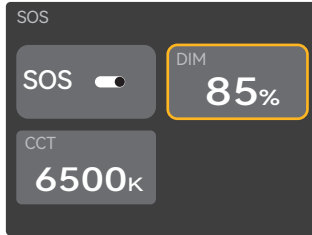

## Menu Settings

Short press the MENU button to enter menu settings, turn the select dial to select among the following options: DMX, Bluetooth, wireless, dimming curves, quick boot, display, language, upgrade, factory default, fixture info.

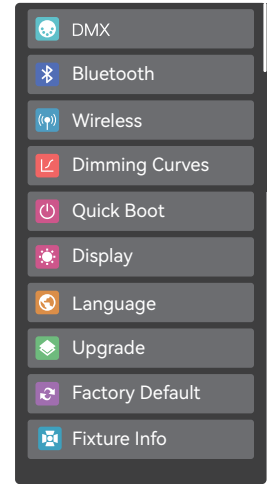

### 1. DMX

Short press the select dial to enter DMX setting interface. Turn the select dial to select options among address, DMX mode, extend DMX, DMX lost, RDM state. Short press the select dial to select the desired option then rotate to adjust settings. Finally, short press the MENU button to return to the previous menu.

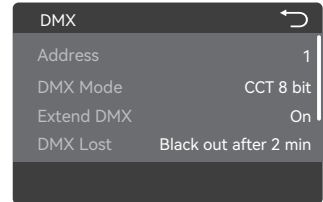

Level 1 Option	Level 2 Option	Description
<b>Address</b>	1-512	Initial address
<b>DMX Mode</b>	CCT 8 bit	CCT 8 bit
	FX 8 bit	FX 8 bit
	ULTIMATE 8 bit	ULTIMATE 8 bit
<b>Extend DMX</b>	On	Turn on extend DMX channels
	Off	Turn off extend DMX channels
<b>DMX Lost</b>	Hold Last Command	After the DMX control signal is lost, continue to use the last received DMX control signal until power down or a valid DMX control signal is received again.
	Black Out	The light is off immediately.
	Black Out After 2 Min	After the DMX control signal is lost, continue to use the last received DMX control signal for 2 minutes then black out. Note: If a valid DMX control signal is received within 2 minutes, then use the new DMX control signal.
<b>RDM Status</b>	On	Turn on RDM
	Off	Turn off RDM

DMX Practical Table

CCT 8Bit Mode						
DMX Channel	Function	Parameters	DMX Value 8 Bit		Practical Parameters Values 8Bit	
			Initial Value	Ending Value	Initial Value	Ending Value
1	CCT	DIM	0	255	0.0%	100.0%
2		CCT	0	255	2700K	8500K

FX 8Bit Mode						
DMX Channel	Function	Parameters	DMX Value 8 Bit		Practical Parameters Values 8Bit	
1	FX Type	DIM	0	255	0.0%	100.0%
			0	9	Off	
			10	19	Flash	
			20	29	Lightning	
			30	39	Cloudy	
			40	49	Broken Bulb	
			50	59	TV	
			60	69	Candle	
			70	79	Fire	
			80	89	Firework	
			90	99	Explosion	
			100	109	Welding	
			110	119	SOS	
120	255	Preset				
3	Flash	CCT	0	255	2700K	8500K
		Speed	0	255	1	100
		Mode	0	255	0 Camera Flash	1 Flash Bulb
4	Lightning	CCT	0	255	2700K	8500K
		Times	0	255	0(random)	10
		Frequency	0	255	0(random)	20
3	Cloudy	DIM Ratio	0	255	30%	90%
		Speed	0	255	0(random)	100
3	Broken Bulb	CCT	0	255	2700K	8500K
		Speed	0	255	1	100
3	TV	Speed	0	255	1	100
3	Candle	Speed	0	255	1	100
3	Fire	Speed	0	255	1	100
3	Firework	Speed	0	255	1	100
		Embers	0	255	1	100
		CCT	0	255	2700K	8500K
4	Explosion	Speed	0	255	1	100
		Embers	0	255	1	100
3	Welding	CCT	0	255	2700K	8500K
		Speed	0	255	1	100
3	SOS	CCT	0	255	2700K	8500K

ULTIMATE 8Bit Mode						
DMX Channel	Function	Parameters	DMX Value 8 Bit		Practical Parameters Values 8Bit	
1		DIM	0	255	0.0%	100.0%
2		Mode Selection	0	9	CCT Mode	
			10	19	FX Mode	
			20	255	Preset	
3		Color Parameter 1				

CCT Parameter in ULTIMATE 8Bit Mode						
DMX Channel	Function	Parameters	DMX Value 8 Bit		Practical Parameters Values 8Bit	
3	CCT	CCT	0	255	2700K	8500K

FX Parameter in ULTIMATE 8Bit Mode						
DMX Channel	Function	Parameters	DMX Value 8 Bit		Practical Parameters Values 8Bit	
3	FX	FX Type	0	9	Off	
			10	19	Flash	
			20	29	Lightning	
			30	39	Cloudy	
			40	49	Broken Bulb	
			50	59	TV	
			60	69	Candle	
			70	79	Fire	
			80	89	Firework	
			90	99	Explosion	
			100	109	Welding	
			110	119	SOS	
			120	255	Preset	
4	Flash	CCT	0	255	2700K	8500K
5		Speed	0	255	1	100
6		Mode	0	255	0 Camera Flash	1 Flash Bulb
4	Lightning	CCT	0	255	2700K	8500K
5		Times	0	255	0(random)	10
6		Frequency	0	255	0(random)	20
4	Cloudy	DIM Ratio	0	255	30%	90%
5		Speed	0	255	0(random)	100
4	Broken Bulb	CCT	0	255	2700K	8500K
5		Speed	0	255	1	100
4	TV	Speed	0	255	1	100
4	Candle	Speed	0	255	1	100
4		Firework	Speed	0	255	1
5		Embers	0	255	1	100
4	Explosion	CCT	0	255	2700K	8500K
5		Speed	0	255	1	100
6		Embers	0	255	1	100
4	Welding	CCT	0	255	2700K	8500K
5		Speed	0	255	1	100
4	SOS	CCT	0	255	2700K	8500K



## 2. Bluetooth

Short press the select dial to enter Bluetooth setting interface. Turn the select dial to select options between switch and reset. Short press the select dial to select the desired option then rotate to adjust settings. Finally, short press the MENU button to return to the previous menu.

Bluetooth MAC Code is on the left bottom of the display for searching the fixture via Bluetooth.

Scan the QR code to download the "Godox Light" smartphone app (Available for both Android and iOS systems).

### Note:

1. The app can be used directly on the firstly installed device (smartphone or iPad). When change to other mobile device (smartphone or iPad), the light shall be reset before the normal connection of the app.
2. The app should be upgraded to version 3.0 or above.

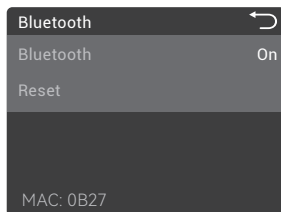

## 3. Wireless

Short press the select dial to enter wireless setting interface. Turn the select dial to select options among switch, GR, CH, ID. Short press the select dial to select the desired option then rotate to adjust settings. Finally, short press the MENU button to return to the previous menu.

Wireless: Turn on/off 2.4G wireless

GR: 0-9/A-F

CH: 01-32

ID: 0FF/01-99

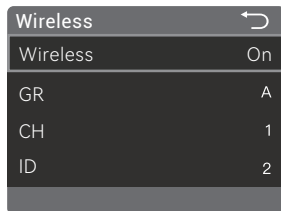

Note: When using the remote control RC-A6II (sold separately) or remote control RC-R9II (sold separately), the group, channel and ID of the remote control and AT200Bi should be the same.

## 4. Dimming Curves

Short press the select dial to enter dimming curves setting interface. Turn the select dial to choose among linear, s-curve, exponential and logarithmic. Finally, short press the select dial/MENU button to return to the previous menu.

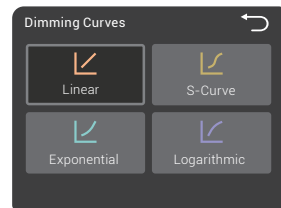

## 5. Quick Boot

Short press the select dial to enter quick boot setting interface. Turn the select dial to turn on or off the quick boot function. Finally, short press the select dial/MENU button to return to the previous menu.

Note: The controller will turn on automatically after connecting to power source and the quick boot function is turned on.

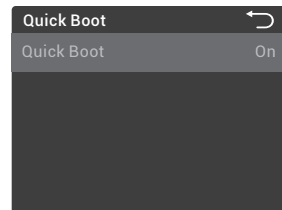

## 6. Display

Short press the select dial to enter display setting interface. Turn the select dial to adjust display brightness from 20% to 100%. Finally, short press the MENU button to return to the previous menu.

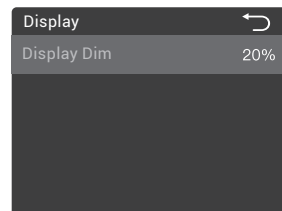

## 7. Language

Short press the select dial to enter language setting interface. Turn the select dial to select between Chinese and English. Finally, short press the MENU button to return to the previous menu.



## 8. Upgrade

Short press the select dial to enter upgrade setting interface to check the firmware version and upgrade instruction. Then, short press the MENU button to return to the previous menu.



## Firmware Upgrade

1. Download the new firmware to the U disk from official website <https://www.godox.com/firmware-continuous-light>.
2. Turn off the device. Insert the U disk with new firmware into the USB Type-A port.
3. Turn on the device, and it will automatically enter the upgrade interface.
4. It will return to main interface after completion.

### Notes:

1. New firmware must be downloaded from the official website, and keep only one BIN file in the root directory of the USB disk.
2. The USB Type-A port can only support output voltage and current of 5V/1A. Do not connect to over-rated USB device.

## 9. Factory Default

Short press the select dial to enter factory default setting interface. Turn the select dial to select apply or cancel. It will return to language setting interface after reset.

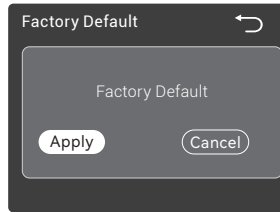

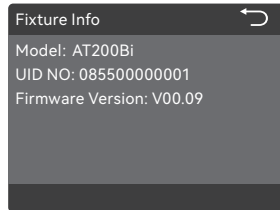

## 10. Fixture Info

Short press the select dial to enter fixture info setting interface to check model, UID NO. and firmware version. Then, short press the MENU button to return to the previous menu.



## Lock Setting

Short press the  /MODE button, the panel is locked when  is displayed on the panel, short press again to unlock.

Note: The locking function only works on the controller panel, other operations are still available.

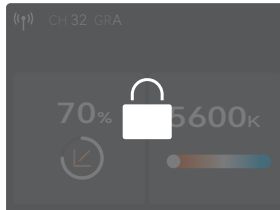

## Preset Setting

Short press the PRESET button to enter preset effects interface. Turn the select dial to choose and enter preset effects 1-10, then short press to choose save or cancel. Then, short press the select dial to return to the previous menu and short press the PRESET button to exit.

Note: It will not display any option for certain group that have not been preset any effect.

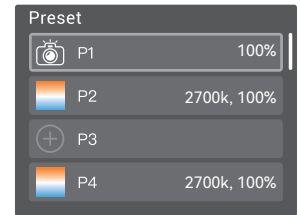

## Maintenance

This product, except consumables, is supported with a one-year warranty. Unauthorized service will void the warranty.

Maintenance of the light must be performed by our authorized maintenance department which can provide original accessories.

Changes made to the specifications or designs may not be reflected in this manual.

## Photometric Data

CCT	Unit	1m	2m	3m
2800K	lux	≈1720	≈549	≈267
	fc	≈160	≈51	≈24.8
3200K	lux	≈1860	≈599	≈290
	fc	≈173	≈55.6	≈27
4300K	lux	≈2160	≈692	≈343
	fc	≈200	≈64.3	≈31.9
5600K	lux	≈2230	≈712	≈353
	fc	≈207	≈66.2	≈32.8
6500K	lux	≈2210	≈704	≈349
	fc	≈205	≈65.4	≈32.4
7500K	lux	≈2150	≈685	≈339
	fc	≈200	≈63.6	≈31.5
8500K	lux	≈2050	≈654	≈325
	fc	≈191	≈60.7	≈30.2

The data above are averages, not absolutes. All the above tests are based on the condition of 100% brightness.

## Technical Data

Model	AT200Bi
Power Supply	100V-240V-50/60Hz 2.1A
Max. Power	≈210W
CCT	2700-8500K
Brightness Range	0%-100%
Dimming Curves	linear, s-curve, exponential, logarithmic
FX Modes	11
CRI	Average ≈96
TLCI	Average ≈96
Waterproof Grade of Light Body	IP65
Controlling Methods	DMX 512 Control (support RDM protocol) /2.4GHz Wireless Control/ Bluetooth Control
Bluetooth Controlling Distance	Max.30m
2.4G Remote Control Distance	Max.60m
USB Type-A Port	Firmware Upgrade/5V=1A Power Supply
Dimension	Light Body: 280mm*267mm*1226mm/11*11*48"(With air bag and in the inflated state, does not include the connection cable.) Controller: 124mm*132mm*270mm/4.8*5*10.6"
Netweight≈	Light Body: 2.15kg(Including airbag) Controller: 2.8kg

Specifications and data may subject to changes without notice.

## FCC Statement

This device complies with part 15 of the FCC Rules. Operation is subject to the following two conditions:

- (1) This device may not cause harmful interference, and
- (2) this device must accept any interference received, including interference that may cause undesired operation.

Any Changes or modifications not expressly approved by the party responsible for compliance could void the user's authority to operate the equipment.

Note: This equipment has been tested and found to comply with the limits for a Class B digital device, pursuant to part 15 of the FCC Rules. These limits are designed to provide reasonable protection against harmful interference in a residential installation. This equipment generates uses and can radiate radio frequency energy and, if not installed and used in accordance with the instructions, may cause harmful interference to radio communications. However, there is no guarantee that interference will not occur in a particular installation. If this equipment does cause harmful interference to radio or television reception, which can be determined by turning the equipment off and on, the user is encouraged to try to correct the interference by one or more of the following measures:

- Reorient or relocate the receiving antenna.
  - Increase the separation between the equipment and receiver.
  - Connect the equipment into an outlet on a circuit different from that to which the receiver is connected.
  - Consult the dealer or an experienced radio/TV technician for help.
- The device has been evaluated to meet general RF exposure requirement.  
The device can be used in portable exposure condition without restriction.

## Warning

Operating frequency:2412.99MHz – 2464.49MHz(2.4G only receive)/2402MHz – 2480MHz (BT)  
Maximum EIRP Power: 5dBm

## Declaration of Conformity

GODOX Photo Equipment Co.,Ltd. hereby declares that this equipment are in compliance with the essential requirements and other relevant provisions of Directive 2014/53/EU. In accordance with Article 10(2) and Article 10(10), this product is allowed to be used in all EU member states.For more information of DoC, Please click this web link:

<https://www.godox.com/eu-declaration-of-conformity/>

The device complies with RF specifications when the device used at 0mm from your body.

## 产品保修

尊敬的用户, 本保修卡是申请维修服务的重要凭证, 请您配合销售商填写并妥善保管, 谢谢!

产品信息	型号	产品条码
用户信息	姓名	联系电话
	通信地址	
销售商信息	名称	
	联系电话	
	通信地址	
	销售日期	
备注		

注: 此表应由销售商盖章确认。

### 产品信息

本文件适用于相关《产品保修信息》(见后面说明)所列产品, 其他非属此范围的产品或部件(如促销品、赠品及其他出厂后附加的部件等)不在此保修承诺内。

### 保修期

产品及部件的相应保修期按相关的《产品保修信息》执行。保修期自产品首次购买日起算, 购买日以购买产品时保修卡登记日期为准。

### 如何获得维修服务

您可直接与销售商或授权服务机构联系, 也可拨打神牛产品售后服务电话, 与我们联系, 由我们的服务人员为您安排服务。申请保修时, 您应提供有效的保修卡作为保修凭证, 方可获得保修。如您不能提供有效的保修卡, 则在我们确认产品或部件属于保修范围的情况下, 也可以为您提供保修, 但这不作为我们的义务。

### 不适用保修的情况

如产品存在下列情况, 本文件项下的保证和服务将不适用: ①产品或部件超过相应保修期; ②错误或不适当使用、维护或保管导致的故障或损坏, 如: 不当搬运; 非按产品合理预期用途使用; 不当插拔外接设备; 跌落或外力挤压; 接触或暴露于不当温度、溶剂、酸碱、水浸或潮湿环境; ③由非神牛授权机构或人员安装、修理、更改、添加或拆卸造成的故障或损坏; ④产品或部件原有识别信息被修改变更或删除; ⑤无有效保修卡; ⑥使用非合法授权、非标准或非公开发行的软件造成的故障或损坏; ⑦因不可抗力或意外事件造成的故障或损坏; ⑧其他非因产品本身质量问题导致的故障或损坏。遇上述情况, 您应向相关责任方寻求解决, 神牛对此不承担任何责任。因非在保修期或保修范围内的部件、附件或软件导致产品不能正常使用的, 不是保修范围内的故障。产品使用过程中正常的脱色, 磨损和消耗, 不是保修范围内的故障。

## 产品保修和服务支持信息

产品的保修期和服务类型按以下《产品保修信息》执行:

产品类别	选件名称	保修期(月)	保修服务类型
部件	电路板	12	客户送修
	电池	3	客户送修
	充电器等带电性能的部件。	12	客户送修
其他	如外壳、保护罩、锁紧装置、包装等。	无	无保修

神牛产品售后服务电话 0755-29609320-8062

## Warranty

Dear customers, as this warranty card is an important certificate to apply for our maintenance service, please fill in the following form in coordination with the seller and safe-keep it. Thank you!

Product Information	Model	Product Code Number
Customer Information	Name	Contact Number
	Address	
Seller Information	Name	
	Contact Number	
	Address	
	Date of Sale	
Note		

Note: This form shall be sealed by the seller.

### Applicable Products

The document applies to the products listed on the Product Maintenance Information (see below for further information). Other products or accessories (e.g. promotional items, giveaways and additional accessories attached, etc.) are not included in this warranty scope.

### Warranty Period

The warranty period of products and accessories is implemented according to the relevant Product Maintenance Information. The warranty period is calculated from the day (purchase date) when the product is bought for the first time, and the purchase date is considered as the date registered on the warranty card when buying the product.

### How to Get the Maintenance Service

If maintenance service is needed, you can directly contact the product distributor or authorized service institutions. You can also contact the Godox after-sale service call and we will offer you service. When applying for maintenance service, you should provide valid warranty card. If you cannot provide valid warranty card, we may offer you maintenance service once confirmed that the product or accessory is involved in the maintenance scope, but that shall not be considered as our obligation.

### Inapplicable Cases

The guarantee and service offered by this document are not applicable in the following cases: ① **The product or accessory has expired its warranty period;** ② **Breakage or damage caused by inappropriate usage, maintenance or preservation, such as improper packing, improper usage, improper plugging in/out external equipment, falling off or squeezing by external force, contacting or exposing to the improper temperature, solvent, acid, base, flooding and damp environments, etc;** ③ **Breakage or damage caused by non-authorized institution or staff in the process of installation, maintenance, alternation, addition and detachment;** ④ **The original identifying information of product or accessory is modified, alternated, or removed;** ⑤ **No valid warranty card;** ⑥ **Breakage or damage caused by using illegally authorized, nonstandard or non-public released software;** ⑦ **Breakage or damage caused by force majeure or accident;** ⑧ **Breakage or damage that could not be attributed to the product itself.** Once met these situations above, you should seek solutions from the related responsible parties and Godox assumes no responsibility. The damage caused by parts, accessories and software that beyond the warranty period or scope is not included in our maintenance scope. The normal discoloration, abrasion and consumption are not the breakage within the maintenance scope.

## Maintenance and Service Support Information

The warranty period and service types of products are implemented according to the following Product Maintenance Information:

Product Type	Name	Maintenance Period(month)	Warranty Service Type
Parts	Circuit board	12	Customer sends the product to designated site
	Battery	3	Customer sends the product to designated site
	Electrical parts e.g.battery charger, etc.	12	Customer sends the product to designated site
Other Items	Lamp body, lamp cover, locking device, package, etc.	No	Without warranty

Godox After-sale Service Call +86-755-29609320(8062)