

合格证
QC PASS

Godox

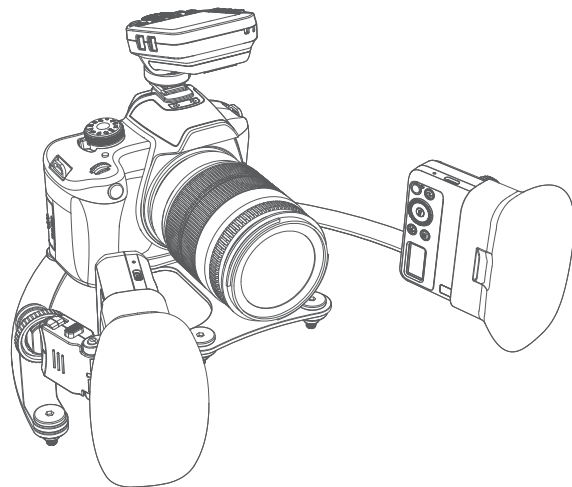

Wechat
Official Account
神牛微信公众号

深圳市神牛摄影器材有限公司

地址: 深圳市宝安区福海街道塘尾社区福川工业区厂房2栋 电话: 0755-29609320(8062)

传真: 0755-25723423 邮箱: godox@godox.com

GODOX Photo Equipment Co., Ltd.

Add.: Building 2, Yaochuan Industrial Zone, Tangwei Community, Fuhai Street, Bao'an District,

Shenzhen 518103, China Tel: +86-755-29609320(8062) Fax: +86-755-25723423

E-mail: godox@godox.com

godox.com

Made in China | 705-F12DK1-02



MF12-DK1

牙科双头闪光灯套装
Dental Flash System

使用手册
Instruction Manual

说明书安全提示

重要安全提示

本产品属于专业摄影设备，需要专业人员操作使用。

使用时必须遵守以下基本安全防护措施：

使用前必须拆除产品上的所有运输保护材料和包装。

1. 使用本产品前，请仔细阅读并完全理解产品说明书，严格按照说明书中的安全提示操作。否则，可能导致死亡、严重伤害、产品损坏或其他财产损失的安全隐患。
2. 本设备（影室闪光灯）必须连接到接地插座中。
3. 闪光灯工作时存在高电压，关机后设备内部电容仍将持续带电一段时间。
4. 本产品为专业灯具，儿童禁止使用。儿童接近时，成人必须密切监督，防止儿童碰撞灯具或私自使用灯具，造成人身伤害。
5. 本灯具并非普通灯具，不可用于普通照明，任何有过眼部损伤或眼部敏感的人群均应避免使用本灯具或直视本灯具。
6. 使用时必须小心，严禁接触如闪光管等高温部件，以避免烫伤。
7. 任何情况下均禁止将闪光灯直接对准人眼（特别是婴儿眼睛），否则短时间内可能导致视力损伤。如感到眼睛不适，应立即关闭灯具，停止使用并及时就医。
8. 如果使用机顶闪光灯与反射板配合，焦距为14mm时，由于焦距过近，严禁长时间使用1/1档位闪光。达到最高热保护次数后，必须暂停10分钟才可继续使用。
9. 闪光管损坏时，应立即停止使用，及时联系制造商、服务代理商或合格维修人员更换，以防发生事故。
10. 严禁使用损坏的设备或配件，必须等待专业维修人员检查维修并确认设备正常后，才可继续使用。
11. 更换灯管、保护玻璃或保险丝前，必须断开电源或者拆下电池（如装有电池），确保灯具与电源完全断开。更换灯管前让其冷却10分钟，操作时需戴绝缘/或隔热手套。
12. 拔插头插头时必须关闭产品电源，插入插头时务必检查是否完全卡入。
13. 使用过程中，如果产品因跌落、挤压或强力冲击导致外壳破裂，应立即停止使用，避免接触内部电子部件而触电受伤。
14. 如果需要使用延长线，请使用原装延长线或选择额定电流大于等于设备的延长线。使用额定电流过小的延长线可能会过热起火。
15. 部分产品电源线较长，请合理放置，避免接触热源或绊倒他人。建议使用原装电源线。非原装线造成的损坏不在保修范围内。
16. 影室闪光灯电源插头可用作断电开关，应保持随时便于操作。
在不使用时，请断开电源。
17. 进行清洁和维修前，请先从电源插座上拔出设备电源插头。不要拉扯电源线强行拔出，正确方法是用双手抓住插头端头拔出。
18. 本设备不防水，请保持干燥，不能浸入水或其他液体。应安装在通风干燥位置，避免在雨天、潮湿、多尘或过热环境中使用。不要在设备上方放置物品，或让液体流入内部，防止发生危险。
19. 未经授权，请不要自行拆卸本产品。产品若出现故障，必须由本公司或授权维修人员检查和维修。
20. 存放设备前，请确保设备已完全冷却，拔下电源线。放入设备包内或通风干燥位置。
21. 请勿将设备放置在酒精、汽油等易燃挥发性溶剂或气体如甲烷、乙烷等附近。
22. 本设备禁止在有爆炸危险的环境中使用或存放。

23. 运行期间和之后，设备灯头与用户和其他人员，以及热敏或可燃物品之间，距离必须始终保持至少1米。
24. 严禁覆盖设备散热口！
25. 请勿使用未经本公司认可的配件，以免造成火灾、触电或人身伤害。
26. 清洁设备时，请用干燥软布轻轻擦拭，不可使用湿布，否则可能会损坏设备。
27. 部分产品配备保护罩，使用前必须取下。
28. 本使用说明基于严格测试制定，设计和规格变更恕不另行通知。您可登录我们官方网站查看最新电子版使用说明，了解产品最新资讯。
29. 部分产品内置锂电池，必须使用专用充电器充电，并按正确操作说明，在规定电压和温度范围内使用。
30. 部分产品使用锂电池供电。这类锂离子电池使用寿命有限，会逐渐失去储能能力，这种能力下降不可逆。电池老化时，产品续航时间会减少。锂离子电池使用寿命预计2—3年。请定期检查电池情况，如果充电时间明显增加或续航时间明显减少，请考虑更换新电池。
31. 部分产品配备锂电池，其储存建议如下：
• 储存前，将电池充放电至约50%电量；至少每6个月充电一次，至约50%电量；
• 可拆卸电池应单独存放；
• 储存温度在0°C至40°C范围内。
32. 部分产品使用锂电池供电，请注意以下事项：
 - 不要拆卸、压碎或刺穿电池；
 - 避免使电池触点短路；
 - 不要在火中或水中处理电池；
 - 不要将电池暴露在60°C以上高温下；
 - 将电池放在儿童接触不到的位置；
 - 防止电池遭受过度冲击或振动；
 - 不要使用已损坏的电池；
 - 如果电池出现泄漏，请避免接触泄漏液体；
 - 如果眼睛接触电池液体，立即用水冲洗至少15分钟，抬起眼睑直到没有液体的迹象后及时就医。
33. 部分产品使用碱性电池供电，使用时注意：
 - 只能使用产品说明书中指定的电池或电源；
 - 请将电池及其他小配件放在儿童和婴幼儿接触不到的位置。如果误吞食电池或小配件，请立即就医；
 - 如果电池漏液、变色、变形、冒烟或散发异味，请立即取出电池。操作时请小心，避免烫伤。继续使用可能引起火灾、电击或皮肤烫伤；
 - 不要使用任何变形或改装过的电池；
 - 不要拆卸或改装产品或电池；
 - 不要加热、焊接电池，或让电池接触火或水；
 - 避免电池受到强力撞击；
 - 请勿将电池的正负端错误插入，或将新旧电池或不同类型的电池混合使用。
34. 处理任何电池前，请确认并遵守当地相关法律法规。
35. 本设备整机的保修期为一年。消耗品（如电池）、适配器、电源线等配件不在保修范围内。
36. 私自维修将取消保修资格，需支付维修费用。
37. 请收到锂电池时及时检查电池状态、电量情况，如有任何质量问题及时在保修期内联系神牛或神牛所授权的经销商。
38. 不当操作导致故障不在保修范围。

前言

感谢您购买神牛产品！

MF12-DK1是一款专为近距离摄影而设计的牙科闪光灯系统。它包含了迷你微距闪光灯、牙科柔光罩和牙科闪光引闪器，并可选配牙科双头支架。该闪光灯配备了两种闪光模式，TTL模式和M（手动）闪光模式，操作简便且循环时间短。此外，MF12-DK1采用了专业的光学镜头设计，对焦效果更强，可确保拍摄光线效果均匀分布。如果您需要进行牙科摄影，MF12-DK1将是您理想的选择。

主要特点

- 支持TTL自动闪光模式和M手动闪光模式
- 支持S1/S2光控引闪方式
- 搭载LED造型灯，为微距调焦时提供照明
- 选用专业光学镜片，出光更加均匀
- 内置2.4G无线：可以远距离控制灯体
- OLED液晶屏：显示界面清晰美观
- 内置锂电池，采用通用TYPE-C充电口
- 全功率闪光约500次，回电快至1.7秒

警告

- ▲ 请保持干燥。
- ▲ 请勿私自拆卸产品，如产品出现故障须由本公司或授权的维修人员进行检查维修。
- ▲ 请勿让儿童接触本产品。
- ▲ 禁止拆卸、撞击、挤压或投入火中，若出现严重鼓胀，请勿继续使用。
- ▲ 请勿放置在超过50度的高温环境中。
- ▲ 请勿将闪光灯头正对人眼闪光(特别是婴儿的眼睛)，否则可能会在短时间内造成视力障碍。
- ▲ 请勿在化学品、可燃性气体或其他特殊物质附近使用闪光灯，这些物质在特殊情况下可能对闪光灯发出的瞬间强光敏感，有可能导致火灾或电磁干扰。在这些场合下，请注意相关警告标识。
- ▲ 本产品不能防水，在雨天及潮湿的环境下注意防水。
- ▲ 若发生任何故障，请立即关闭闪光灯电源。

部件名称

• 机身

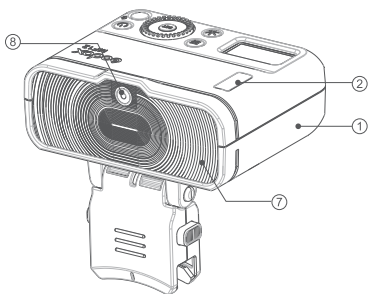

1. 灯体
2. 无线传感器
3. USB Type-C 端口(仅供充电)
4. 复位孔
5. 角度调节固定座
6. 固定座左右推钮
7. 镜片
8. 造型灯

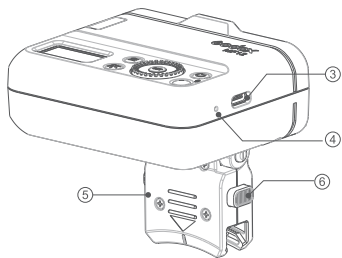

部件名称

• 控制面板

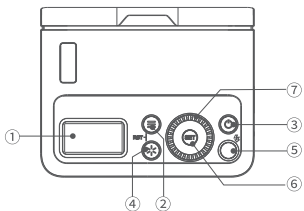

1. 显示屏
2. 菜单按键
3. 电源开关键
4. 造型灯按键
5. 试闪按键
6. SET按键
7. 调节旋钮

• OLED显示屏



TTL模式

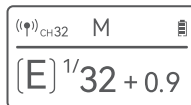

M手动闪光模式

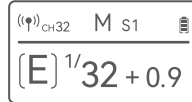

S1/S2

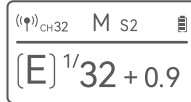

物料清单



收纳包
x 1



牙科引闪器 XPROIS+
x 1



微距灯头 MF12
x 2



牙科柔光罩 MF-DD
x 2



闪光灯灯座
x 2



冷靴座
x 2



USB Type-C 线
x 2



说明书
x 1



安装环 MF-AR
x 1



适配环套装 AR-R Kit
x 1

另购附件



双头支架 MF-DK
x 1

附件安装

如何使用牙科闪光系统

1. 将配光前镜片的亮面朝里，卡入柔光罩的卡口处。把柔光罩穿过闪光灯底部的缺口并往里面推，即安装好。



2. 将MF12的固定座口对准双头支架两侧的滑动块，听到“咔”声表示装到位。然后用位于支架本体两侧的旋钮拧紧锁紧系统。

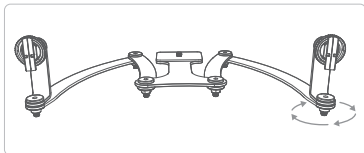
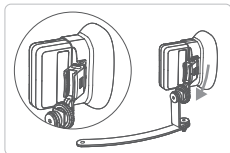

注：位于支架本体两侧的两个手臂末端的球附件可以围绕自身旋转360度，这可以让你以任何你想要的方式移动它们。

3. 支架的每个手臂之间和两端都有两个部分的张力铰链，拉伸支架将闪光灯分开。

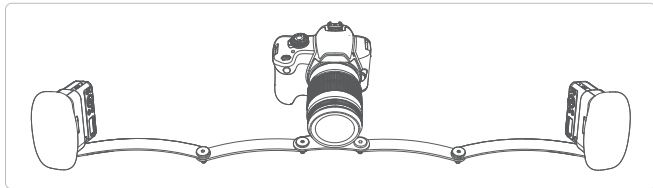

4. 或收缩支架将闪光灯靠近镜头

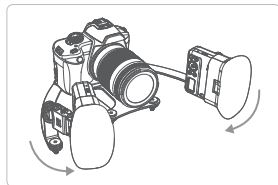

5. 把支架拿到相机前，对准孔位，卡住位置固定好即可。

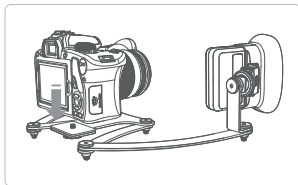

6. 再把引闪器的安装脚完全插入相机的热靴上，直到它们咔嚓一声到位，你就完成了牙科闪光系统的所有设置。

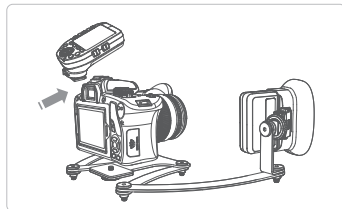

电池

• 特性:

1. 本品采用锂电池，集成在产品里面不可拆卸,使用寿命长。
2. 安全可靠,内置电路有过充保护、过放保护、过流保护、短路保护。
3. 使用USB Type-C 接口充电,一小时内(约55分钟)能充满电。

• 电池电量指示:

电量符号显示	意义
3格	满电
2格	中电
1格	低电
无格	电量少, 请及时充电
	电量用尽,此状态不支持闪光灯工作, 10秒后将自动关机。 注:此状态请尽快(10天内)充电,才可使用或放置。

电源开关控制该产品的打开和关闭，长时间不使用时请关闭电源。

电源管理

自动关机模式设置

按下菜单按键，旋转调节旋钮选择STBY,按SET按键，再旋转调节旋钮进行选择30min/60min/90min/OFF。设置自动关机后，超过（30/60/90分钟）无人操作，闪光灯会自动关机。自动关机时请按电源开关按键唤醒，开机动画出现，滑动调节旋钮即可操作。



注：离机使用时，建议进入菜单C.Fn-STBY，关闭自动关机功能。

造型灯

1. 开关造型灯:

- 1.1. 短按造型灯按键<  >控制LED造型灯的打开和关闭。
- 1.2. 长按造型灯按键进入造型灯设置界面时, 短按SET按键也能控制造型灯的打开和关闭。

2. 造型灯设置:长按< >进入造型灯设置界面。

- 2.1. 亮度设置:选择调节旋钮设定亮度值, 亮度等级10级(1~10)。



闪光模式选择

MF12闪光灯有TTL模式、M(手动)闪光2种模式。在TTL模式下, 相机的测光系统会侦查从主体反射回来的闪光照明,从而自动调节闪光输出量, 使主体和背景得到均衡曝光。所以无论背景的光度如何, 拍摄对象均可以正确地曝光。当你想强调拍摄对象或作出曝光补偿时, 选择TTL模式, 这会对你有所帮助。在M(手动)闪光模式下, 你要选择光圈和闪光输出量。当你很难从自动闪光模式中获得准确曝光来拍摄对象时, 利用这个模式, 你便可控制曝光和闪光的拍摄距离。短按菜单按键<  >, 旋转调节旋钮至MODE, 接着短按SET按键, 最后旋转调节旋钮选择TTL模式或M(手动)闪光模式。

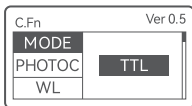

• TTL自动闪光模式

选择TTL, 再按菜单按键<  >返回主界面, 闪光灯进入TTL自动闪光模式。

• M手动闪光模式

您可以在1/128功率至1/1全功率间, 每档以0.1为增量设置闪光输出。

1. 选择M, 再按菜单按键<  >返回主界面, 闪光灯进入M手动闪光模式。
2. 在M模式主界面, 旋转调节旋钮可进行设置闪光输出功率。

为获得正确的闪光曝光, 请使用手持的闪光测光表确定所需的闪光输出。

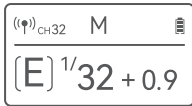

• 光控引闪(PHOTO)设置

在M手动闪光设置下, 按菜单按键<  >进入菜单C.Fn, 旋转调节旋钮选择PHOTOC, 按SET按键, 再旋转调节旋钮进行选择S1或S2功能。

1. S1光控同步引闪设置

选择S1功能, 闪光灯可作为副灯使用, 创造多种照明效果, 适用于手动闪光环境。它会与主闪光灯的第二次闪光同步触发闪光, 效果与使用无线引闪器一致。

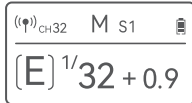
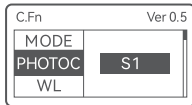

2. S2光控防预闪引闪设置

选择S2功能, 闪光灯可作为副灯使用, 适用于TTL闪光环境。具有防预闪功能, 使用带一次预闪功能的相机能用光控实现同步拍摄。它会与主闪光灯的第二次闪光同步触发闪光, 即2次光控引闪。

 只有在M模式下才支持S1/S2光控引闪模式。

无线电(2.4G)传输

MF12使用神牛2.4G无线X系统, 可以与本厂X1、XPro、X2触发器完美结合使用。作为从属单元, 可兼容佳能/尼康/索尼/松下/奥林巴斯/富士TTL系统, 根据主控单元自动切换, 无需手动设置。尼康相机(使用X1T-N)和佳能相机(使用X1 T-C)和索尼相机(使用X1T-S等)可同时间地共享一台或多台MF12-TTL,无缝结合, 无懈可击!

• 无线 (WL)设置

按菜单按键<  >进入菜单C.Fn, 旋转调节旋钮选择无线WL, 按SET按键, 再旋转调节旋钮进行选择: OFF为关闭无线功能, ON为打开无线功能。

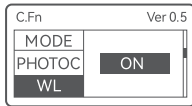

• 频道(CH)设置

如果在拍摄现场不止一个无线闪光系统, 您可以通过更改通讯频道来防止信号干扰。保证主控单元和从属单元设置为相同的频道(CH)编号即可。按菜单按键<  >进入菜单C.Fn, 旋转调节旋钮选择CH,按SET按键, 再旋转调节旋钮进行频道选择(01- 32), 选好后短按SET按键退出频道设置。

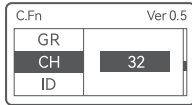

• 组别(GR)设置

进入菜单C.Fn, 旋转调节旋钮选择GR,按SET按键, 再旋转调节旋钮进行组别选择(A/B/C/D/E),选好后短按SET按键退出组别设置。



• ID设置

进入菜单C.Fn, 旋转调节旋钮选择ID,按SET按键, 再旋转调节旋钮进行ID选择(OFF/01~99),选好后短按SET按键退出ID设置。

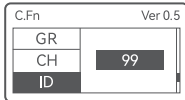

注: 主控单元具备此功能时才能使用。

▲ 神牛2.4G无线漏闪的原因及解决办法:

1. 外部环境2.4G信号干扰(如无线基站、2.4G wifi路由、蓝牙设备等)

- 请调节引闪器的频道CH设置(建议+10), 找到无干扰的频道来工作, 或者在工作时关闭其他2.4G设备。

2. 请确认闪光灯是否已经回电或者回电速度是否已经跟上连拍速度(闪光灯就维持指示灯已经亮起), 并且没有处于过热保护或者其他异常状态中

- 请下调闪光灯功率的档位, 如是TTL模式请尝试改为M模式(TTL模式下需要预闪一次)。



3. 是否引闪器和闪光灯距离太近(距离<0.5m)

- 请在引闪器上打开“近距离无线模式”: Xpro系列: 设置C.Fn-DIST为0-30m。

4. 是否引闪器和接收端设备在低电状态

- 请更换电池(引闪器电池建议使用1.5V一次性碱性电池)。

C.Fn: 设置自定义功能

1. 按菜单按键<  >进入菜单C.Fn, 旋转调节旋钮选择自定义功能符号。
2. 按SET按键选中, 旋转调节旋钮进行设置。
3. 设置好后按SET按键确认, 再按菜单按键<  >退出。

自定义功能符号	功能	设置	设置说明
MODE	闪光模式	M	手动闪光
		TTL	自动闪光
PHOTOC	S1/S2光控引闪	OFF	关闭光控引闪
		S1	S1光控同步引闪
		S2	S2光控防预闪引闪
WL	无线设置	ON	无线打开
		OFF	无线关闭
GR	组别设置	A/B/C/D/E	可以选择A/B/C/D/E任意一个字母
CH	频道设置	1~32	可以选择1~32任意一个数字
ID	ID设置	OFF/01~99	可以选择OFF或01~99任意一个数字
STBY	自动关机	OFF	关闭
		30min	超过30min/60min/90min没有使用
		60min	闪光灯, 该灯会自动进入关机程序
		90min	

• 强制关机功能

当灯体出现死机、无法操作等现象时, 用针插入复位孔, 触发按键, 实现强制关机功能。

• 热保护功能

开启最大档闪光, 闪光次数达到50次时, 显示屏出现热保护符号, 提醒用户闪光灯机体过热。建议让微距闪光灯暂时停止工作。

• 复位功能

同时长按<  >菜单按键与<  >造型灯按键, 实现灯体参数复位功能。

规格参数

型号	MF12
内置锂电池	3.7V/1700mAh
闪光指数(1/1档位)	GN=16.1 (±0.1)
闪光灯功率	12W
闪光灯档位	8级: 1/128~1/1
LED造型灯亮度	1~10级
显示屏	OLED液晶屏
光控引闪	S1光控同步引闪/S2光控防预闪引闪
闪光模式	TTL模式、M手动闪光模式
持续闪光时间	1/1200s~1/34000s
2.4G无线传输	ON/OFF
频道	32个频道: 1~32
组别	5组组别: A/B/C/D/E
ID	OFF/01~99
传输距离	30m
TYPE-C充电电源	5V2A
全功率闪光次数	约500次
回电时间	约0.01~1.7秒
电池电量指示	显示屏右上角提示剩余电量
节能	30min/60min/90min: 超过30min/60min/90min没有使用闪光灯, 该灯自动进入关机程序OFF: 关闭自动关机模式, 节能性能无效
尺寸	81*76.5*64.3mm
净重	≈144g

牙科摄影的应用

把闪光灯安装在支架上，可以让您拍摄出非常明亮的口腔后部照片。这是因为您可以将灯光移动得非常靠近镜头和主体，让光线能够延伸到口腔深处，从而实现更好的照明效果。

相机设置

- 手动模式
- 标准图片风格
- 光圈f25
- 快门速度1/200秒
- ISO -100或自动

• 口腔外视图

前口腔近距离微笑



灯光位置：将闪光灯分开

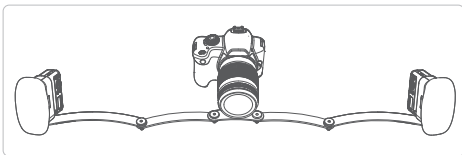

颊部右/左



灯光位置：将闪光灯靠近镜头

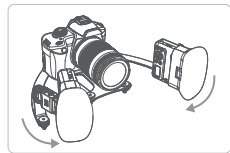

• 口腔内视图

上颌骨/上下颌骨/下咬合

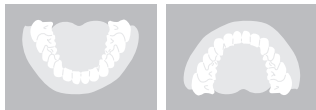

灯光位置：将闪光灯靠近镜头

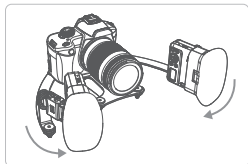

UR/LR舌侧 灯光位置：将闪光灯靠近镜头

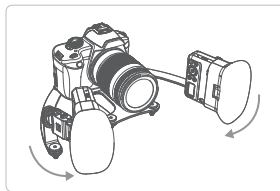

LR/LL舌侧 灯光位置：将闪光灯分开

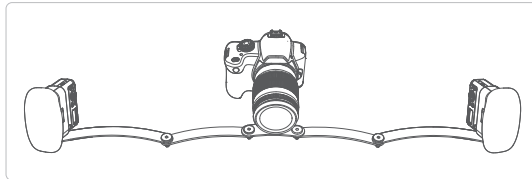

维修保养

- 闪光灯在工作时，如发现异常，应立即关掉电源，查明原因。
- 灯体应避免震动，平时注意表面除尘。
- 灯体稍有发热为正常现象，无特别需要时，勿连续引闪。
- 闪光灯的所有维修概由本厂指定可供原厂配件之维修部负责。
- 1年保修，消耗品如灯管等，不在1年保修范围。
- 经发现，擅自检修此闪光灯的，将取消闪光灯之一年保修期，维修需要收取相关费用。
- 如果本品出现故障或者被水淋湿，在专业人员维修后方可继续使用。
- 如有技术更改，恕不另行通知。

Important Safety Instructions

How to Use the Dental Flash System

This product is a professional photographic equipment, to be operated by professional personnel only.

The following basic safety precautions must be followed when using this product:

All transport protective materials and packaging on the product must be removed before use.

1. Carefully read and fully understand the instruction manual before use and strictly follow the safety instructions. Failure to do so may result in death, serious injury, damage to the product, or other property damage.
2. This device (studio flash) must be connected to a grounded outlet.
3. High voltage exists when the flash is powered on. Internal capacitors will remain charged for some time after power off.
4. This product is a professional lighting fixture, children are prohibited from using it. Children must be closely supervised by adults when approaching the fixture, to prevent collisions with the fixture or unauthorized use that could cause personal injury.
5. This is not an ordinary lighting fixture and must not be used for general illumination. Anyone with a history of eye damage or sensitivity should avoid using this fixture or looking directly at it.
6. Extreme caution must be exercised when using it, do not touch high-temperature parts such as flash tubes to avoid burns.
7. Do not point the flash directly at the eyes (especially baby's eyes) under any circumstances, as this could impair vision in a short time. Turn off immediately if discomfort occurs, stop using, and seek medical attention promptly.
8. When using an on-camera flash with a reflector at a focal length of 14mm, it is strictly prohibited to use the 1/1 power setting for an extended period of time. After reaching the maximum heat protection limit, a 10-minute pause is required before continuing to use the flash.
9. If the flash tube is damaged, stop using it immediately and contact the manufacturer, service agent, or qualified repair personnel for a replacement to prevent accidents.
10. Do not use damaged equipment or accessories. Allow professional repair technicians to inspect and confirm normal operation before continuing use after repairs.
11. Disconnect power source or remove batteries (if it has one) before replacing flash tube, protective glass, or fuses. Allowing 10 minutes to cool before replacing flash tube, and wear insulated or heat resistant gloves when operating.
12. Turn off power before connecting or disconnecting plugs from outlets. Ensure plugs are fully inserted when connecting.
13. Stop using immediately if the product shell is cracked due to falling, squeezing, or strong impact, to avoid touching the internal electronic components and getting an electric shock.
14. If an extension cord is needed, use the original extension cord or choose one with a rated current equal to or greater than the device. Using an extension cord with a smaller rated current may overheat and catch fire.

15. Some products have long power cords, please place them properly to avoid contact with heat sources or tripping others. It is recommended to use the original power cord. Damage caused by non-original cords is not covered by the warranty.
16. The power plug of the studio flash can serve as a power-off switch, it should always be easily operable. Please disconnect the power when not in use.
17. Unplug the equipment power plug from the power socket before cleaning or maintenance. Do not pull the power cord forcibly, use both hands to hold the plug end and pull it out.
18. This device is not waterproof. Keep it dry and avoid immersing it in water or other liquids. It should be installed in a ventilated and dry location and avoid using in rainy, humid, dusty, or overheated environments. Do not place items above the device or allow liquids to flow into it to prevent danger.
19. Do not disassemble without authorization. If the product malfunctions, it must be inspected and repaired by our company or authorized repair personnel.
20. Before storing the device, ensure it has completely cooled down and the power cord is unplugged, then put it in the protective case or a ventilated dry location.
21. Do not place the device near alcohol, gasoline, or other flammable volatile solvents or gases such as methane and ethane.
22. Do not use or store this device in potentially explosive environments.
23. Maintain at least 1 meter distance between the lamp head and the user, other people, and heat-sensitive or flammable items during and after use.
24. Do not cover the heat dissipation port!
25. Do not use accessories not been approved by our company, as this may cause fire, electric shock or personal injury.
26. Clean gently with a dry cloth. Do not use a wet cloth as it may damage the device.
27. Some products are equipped with protective covers that must be removed before use.
28. This instruction manual is based on rigorous testing. Changes in design and specifications are subject to change without notice. Check official website for latest instruction manual and product updates.
29. Use only specified charger and follow proper usage instructions for certain products with built-in lithium batteries, within the rated voltage and temperature range.
30. Some products are powered by lithium batteries. These lithium-ion batteries have a limited lifespan and gradually lose their storage capacity, which is irreversible. As the battery ages, the product's battery life will decrease. The estimated lifespan of a lithium-ion battery is 2 to 3 years. Please regularly check the battery's condition, and if the charging time significantly increases or the battery life significantly decreases, consider replacing it with a new battery.
31. Some products are equipped with lithium batteries. The recommended storage guidelines are as follows: Before storage, charge the battery to approximately 50% capacity. Charge it to about 50% at least every six months. If the battery is removable, store it separately. The storage temperature should be within the range of 0°C to 40°C.
32. Some products are powered by lithium batteries. Please note:

- Do not disassemble, crush, or puncture the battery;
- Avoid short-circuiting the battery contacts;
- Do not expose the battery to fire or water;
- Do not expose the battery to temperatures above 60°C;
- Keep out of reach of children;
- Protect the battery from excessive shock or vibration;
- Do not use a damaged battery;
- If the battery leaks, avoid contact with the leaking fluid;
- If the battery fluid comes into contact with your eyes, immediately rinse with water for at least 15 minutes. Lift your eyelids until there are no signs of fluid and seek medical attention promptly.

33. Some products are powered by alkaline batteries. Please note:

- Use only the batteries or power sources specified in the instruction manual;
- Keep batteries and other small accessories out of the reach of children and infants. If a battery or small accessory is accidentally swallowed, seek medical attention immediately;
- If the battery leaks, changes color, deforms, smokes or emits an unusual smell, remove the battery immediately. Be careful during operation to avoid burns. Continued use may cause fire, electric shock, or skin burns;
- Do not use any deformed or modified batteries;
- Do not disassemble or modify the product or battery;
- Avoid heating, welding, exposing the battery to fire or water;
- Avoid strong impacts on the battery;
- Do not mismatch positive and negative terminals of the battery, or mix old and new or different types of batteries.

34. Confirm and comply with all relevant local laws and regulations when handling any batteries.

35. The warranty period for this device as a whole is one year. Consumables (such as batteries), adapters, power cords, and other accessories are not covered by the warranty.

36. Unauthorized repairs will void the warranty and will incur charges.

37. Please check the status and power of the lithium battery upon receipt. If there are any quality issues, please contact Godox or our authorized dealer within the warranty period.

38. Failures from improper operation is not covered under warranty.

Foreword

Thank you for buying a Godox product!

The MF12-DK1 is a dental flash system designed specifically for macro photography. The flash system includes two macro flashes, two dental diffusers, a dental flash trigger and more, and can be optionally paired with a dental bracket. MF12-DK1 is equipped with two flash modes, TTL and M (manual). It is easy to operate and has a short recycle time. Additionally, the MF12-DK1 features a professional optical lens design that enhances focusing performance, ensuring even light distribution in captured images. If you require dental photography, the MF12-DK1 is an ideal choice for you.

Main Features

- Equipped with TTL automatic flash mode and M manual flash mode
- Features an S1/S2 optical flash triggering mode
- Use of a constant light LED modeling light
- Uses professional optical lens for even light distribution
- With built-in 2.4G wireless X system
- Features a clear OLED display
- Includes a built-in lithium battery that can be recharged via the USB Type-C port.
- With a max. of 1.7 secs recycle and 500 full power pops

▲ Warning

- ▲ Always keep this product dry.
- ▲ Do not disassemble. Should repairs become necessary, this product must be sent to an authorized maintenance center.
- ▲ Keep out of reach of children.
- ▲ Do not disassemble, hit, squeeze, or expose to open flame. If severe swelling occurs, do not continue to use.
- ▲ Do not leave or store the flash unit if the ambient temperature reads over 50°, otherwise the electronic parts may be damaged.
- ▲ Do not shoot the flash directly at human eyes (especially the eyes of infants), as this may cause visual impairment in a short period of time.
- ▲ Do not use the flash unit in the presence of flammable gases, chemicals and other similar

materials. Under certain circumstances, these materials may be sensitive to the strong light emitted by this flash unit, which could cause a fire or electromagnetic interference.

- ▲ As this product is not waterproof, do not use in rain or damp conditions.
- ▲ Turn off the flash unit immediately in the event of a malfunction.

Names of Parts

• Body

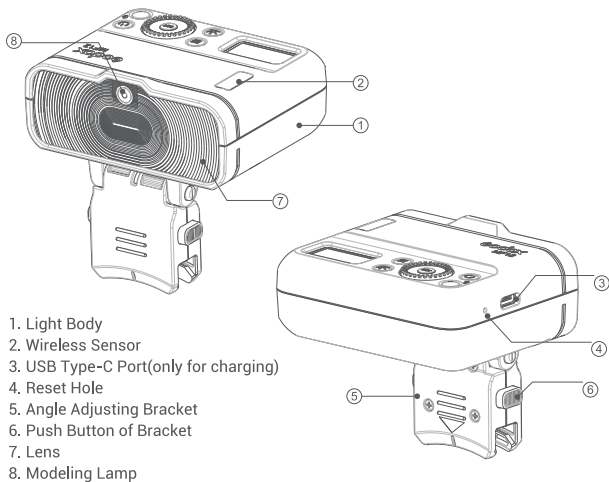

1. Light Body
2. Wireless Sensor
3. USB Type-C Port(only for charging)
4. Reset Hole
5. Angle Adjusting Bracket
6. Push Button of Bracket
7. Lens
8. Modeling Lamp

• Control Panel

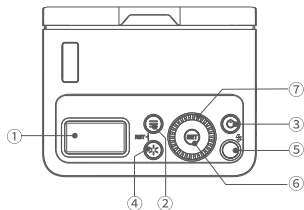

1. Display
2. Menu Button
3. Power Switch
4. Modeling Lamp Button
5. Test Button
6. Set Button
7. Select Dial

• OLED Display



TTL Autoflash

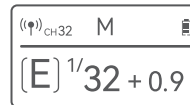

M Manual Flash

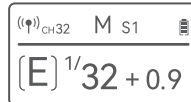

S1/S2



What's Inside

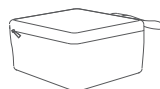

Storage Case
x 1



Dental Flash
Trigger XProHS+
x 1



Macro Flash MF12
x 2



Dental Diffuser
MF-DD
x 2



Flash Stand
x 2



Cold Shoe Adapter
x 2



USB Type-C Cable
x 2



Instruction Manual
x 1



Mounting
Ring MF-AR
x 1



Adapter Rings AR-R Kit
x 1

Optional Accessories



Dental Bracket MF-DK
x 1

Install Accessories

How to Use the Dental Flash System

1. Insert the diffusing optics with the shiny side facing inward into the slot of the dental diffusers. Then insert the two dental diffusers through the bottom of the flash units and push them inside.



2. Slip the socket of MF12 all the way into the cold shoe and push it until a 'click' can be heard, then use the knob located on both sides of the bracket body to tighten the locking system.

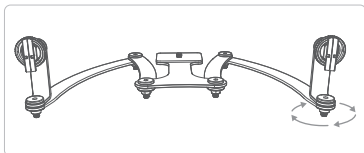
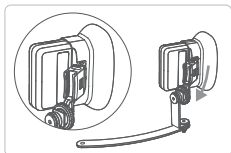

Note: The ball attachment at the ends of the two arms located on both sides of the bracket body can rotate 360 degrees around itself, which can orientate the flash at any angle

3. Each arm of the bracket has two sections with tension hinges in between and at both ends, extend the bracket to separate the flashes for anterior views.

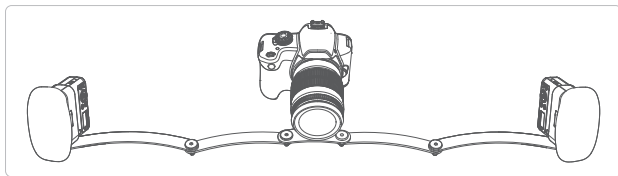

4. Or fold up the bracket to bring the flashes units in close to the lens for intraoral views.

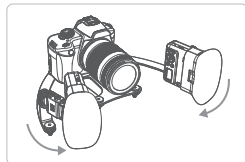

5. Attach the camera onto the mounting thread of the dental bracket, align the holes and snaps in place.

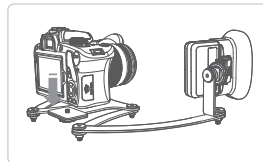

6. Slip the dental flash trigger's mounting foot all the way into the camera's hot shoe until they click in place, and you are all set of the dental flash system.

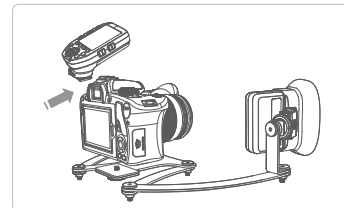

Battery

1. This product uses a Li-ion battery that's non-detachable and has a long battery life.
2. It is safe and reliable. The inner circuit is against overcharge, overdischarge, overcurrent, and short circuit.
3. It takes only approx. 55 minutes (within 1 hour) to fully charge the battery by using the 5V/2A charger.

• Battery Level Indicator

Battery Level	Meaning
3 Bars	Fully charged
2 Bars	Medium level
1 Bar	Low level
0 Bar	The battery level is low, please charge it promptly.
 is displayed	The battery is depleted, and in this state, the flash function is not supported. The device will automatically power off after 10 minutes. Note: In this state, the device must be charged (within 10 days) before it can be used or stored.

The power switch controls the on and off of this product. Please turn off the power when not in use for an extended period of time.

Power Management

Auto Power off Mode Setting



Press the menu button, turn the Dial to select STBY, press the SET button, and then turn the Dial to select 30min/60min/90min/OFF. After setting the auto power off mode, the flash will automatically turn off if it is left for a long time (more than 30/60/90 minutes). To awaken the device from automatic shutdown, please press the power switch button. Once the boot animation appears, you can operate the device by sliding the adjustment knob.



When using the flash separately from the camera, it is recommended to turn off the "auto power off" mode through C.Fn-STBY of custom setting functions.

Modeling Lamp

1. Modeling lamp power ON/OFF:

- 1.1. Short press the <  > button to turn the LED modeling lamp on or off.
- 1.2. Long press the <  > button to enter the modeling lamp interface and then short press SET button to turn the modeling lamp on or off.

2. Modeling lamp setting: long press the < > button to enter modeling lamp interface.

- 2.1 Brightness setting: turn the select dial to adjust the brightness value from 1 to 10 levels.



Flash Mode Selection

MF12 flash has two modes: TTL autoflash and M manual flash. In TTL mode, the camera and the flash will work together to calculate the correct exposure for the subject and the background.

The main subject is correctly exposed regardless of the background brightness. This is useful when you want to highlight the main subject or make exposure compensation.

In Manual flash photography, you need to select the aperture and flash output level. In this way, you can control the exposure and flash shooting distance when shooting subjects that are difficult to expose correctly in the TTL auto flash mode.

Short press the <  > menu button and turn the select dial to select MODE. Then, short press the SET button and turn the select dial to select TTL or M mode. Then, short press the SET button to exit the Mode Selection.

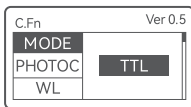

• TTL Autoflash Mode

Select TTL mode and press the <  > menu button to return to the interface and the flash will enter the TTL autoflash mode.

• M Manual Flash Mode

The flash output is adjustable from 1/128 to 1/1 full power in 0.1 and 1 step increment.

1. Select M and press the <  > menu button to return to the main interface.
2. In M mode's main interface, turn the select dial to set the flash output value.

To obtain a correct flash exposure, use a hand-held flash meter to determine the required flash output.

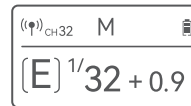

• Light Control Flash (PHOTOC)

In M manual mode, press the <  > menu button to enter C.Fn and turn the select dial to choose PHOTOC. Then, press the SET button and turn the select dial to select S1 or S2 function.

• S1 Secondary Optic Triggering

Select S1 light control synchronous. flash MF12 can be used as an auxiliary light to create a variety of lighting effects, which are suitable for manual flash environment. It will trigger the flash synchronously with the first flash of the main flash. The effect is the same as when you use the wireless flash guide, and the response is sensitive.

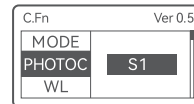

• S2 Secondary Optic Triggering with Anti-preflash

Select S2 light control to prevent pre flash, MF12 can be used as an auxiliary light, which is suitable for TTL automatic flash shooting environment. With high-energy anti pre flash function, when using the camera with a pre flash function, S2 light control pre flash function is used to achieve synchronous shooting. At the same time, it will trigger the flash synchronously with the second flash of the main flash with TTL function, that is, the second light-controlled trigger flash.

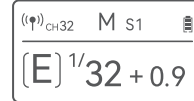

 MF12 flash only supports S1/S2 light control flash in M manual flash mode.

Wireless Transmission

With built-in Godox 2.4G wireless X system, this MF12 can be used in combination with Godox X1, XPro and X2 trigger. As an auxiliary unit, MF12 can be compatible with Canon, Nikon, Sony, Panasonic, Olympus/Fuji system. And it can be switched automatically. Nikon camera (using X1T-N), Canon camera (using X1T-C) and Sony camera (using X1T-S) can share one or more MF12's TTL functions.

• Wireless (WL) Setting

Press the  > menu button to enter C.Fn custom setting. Turn the select dial to choose wireless WL, press the SET button, and turn the select dial to choose ON or OFF. OFF means the wireless function is turned off while ON means it's on.

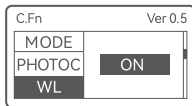

• Channel (CH) Setting

If there are other wireless flash systems nearby, you can change the channels to prevent signal interference. The channel (CH) of the transmitter unit and the receiver unit(s) must be set to the same. Press the  > menu button to enter C.Fn menu. Turn the select dial to select CH. Press the SET button and turn the select dial to select channel from 01- 32. Then, short press the SET button to exit CH setting.

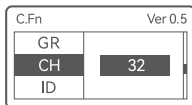

• Group (GR) Setting

Enter C.Fn menu and turn the select dial to select GR. Press the SET button and turn the select dial to select group from A/B/C/D/E. Then, short press the SET button to exit GR setting.

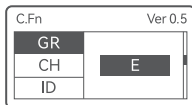

• ID Setting

Enter C.Fn menu and turn the select dial to select ID. Press the SET button and turn the select dial to select ID from OFF and 01 to 99. Then, short press the SET button to exit ID setting.

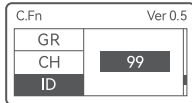

Note: only usable if the master unit has this function.

⚠ The Causes & Solutions of Non-triggering in

Godox 2.4G Wireless

1. Disturbed by the 2.4G signal in external environment (e.g. wireless base station, 2.4G wifi router, Bluetooth, etc.)

→ To adjust the channel CH setting on the flash trigger (add 10+ channels) and choose interference-free channels to work on, or turn off other 2.4G devices while working.

2. Please make sure that the flash has recycling or has caught up with the continuous shooting speed (the flash ready indicator lights up) and the

flash is not in the state of over-temperature protection or other abnormal situation.

→ Please reduce the flash power output. If the flash is in TTL mode, please try to change it to M mode(a preflash is needed in TTL mode).

3. Whether the distance between the flash trigger and the flash is too close or not



→ Please turn on the "close distance wireless mode" on the flash trigger (<0.5m):

→ X1 series: Press and hold the flash button, then turn on the machine until the indicator light flashes twice. X2, Xpro series: Set C.Fn-DIST to 0-30m.

4. Whether or not the flash trigger and the receiver are in the low battery states

→ Please replace the battery (1.5V disposable alkaline batteries are recommended for flash triggers).

C.Fn: Setting Custom Functions

1. Press the  > button to enter C.Fn and turn the select dial to select the custom setting functions.
2. Press the SET button and turn the select dial to set the parameters.
3. After finishing all the settings, press the SET button to confirm and press the  > button to exit.

Custom Function	Functions	Settings	Settings & Descriptions
Signs MODE	Flash mode	M	Manual flash
		TTL	Auto flash
PHOTOC	S1/S2 Light controlled flash	OFF	Off
		S1	S1 Secondary Optic Triggering
		S2	S2 Secondary Optic Triggering with Anti-preflash
WL	Wireless setting	ON	Wireless on
		OFF	Wireless off
GR	Group setting	A/B/C/D/E	Choose any letters from A/B/C/D/E
CH	Channel setting	1~32	Choose any figure from 1 to 32
ID	ID setting	OFF/01~99	Choose any figure from 01 to 99 or OFF
STBY	Auto power off	OFF	Off
		30min	The flash will automatically shut down if left unused for a long time(more than 30/60/90 minutes).
		60min	
		90min	

• Forced Shutdown Function

In the event of a system crash or inability to operate the lamp, insert a pin into the reset hole to force the unit to shut down.

• Over-Temperature Protection

When the continuous flashes fires up to 50 times in fast succession at 1/1 full power, an Over-Temperature Protection icon appears on the display to remind the user that the flash unit is overheated. It is recommended to temporarily stop the macro flash.

• Reset Function

Long press <  > menu button and <  > modeling lamp button at the same time to realize the function of reset the settings.

Technical Data

Model	MF12
Built-in Lithium Battery	3.7V/1700mAh
Guide No. (1/1 output)	GN=16.1 (±0.1)
Flash Power	12W
Output Level	8 levels: 1/128~1/1
Brightness of LED Modeling Lamp	1~10 Levels
Display	OLED Display
Optical Flash	S1 Secondary Optic Triggering S2 Secondary Optic Triggering with Anti-preflash
Flash Mode	TTL Autoflash, M manual flash
Flash Duration	1/1200s~1/34000s
2.4G Wireless Transmission	ON/OFF
Channel	32 channel: 1~32
Group	5 group: A/B/C/D/E
ID	OFF/01~99
Transmission Distance	30m
Type-C Power Charging	5V 2A
Full Power Flashes	Approx. 500
Recycle Time	Approx. 0.01~1.7s
Battery Level Indication	Battery level indicator shows on the upper right corner of the display
Power Saving	30min/60min/90min: It will automatically power off if it is unattended over 30min/60min/90minutes Turn off the auto power off mode, power saving function is invalid..
2.4G Wireless Frequency Range	2413.0MHz-2464.5MHz
Dimension	81*76.5*64.3mm
Net Weight	≈144g

Application of Dental Photography

Having flashes on a bracket allows you to get very well-lit posterior shots because you can move the light very close to the lens and closer to your subject so the light reaches all the way to the back of the mouth.

Camera Settings:

- Manual mode
- Standard Picture Style
- Aperture f25
- Shutter speed 1/200th sec
- ISO -100 or Auto

• Extra-oral Views

Extra-oral up-close smile Positioning of flashes: move the flash further apart

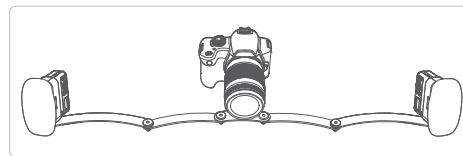

Buccal right/left

Positioning of flashes: move the flash closer to the lens

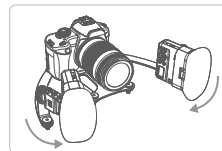

• Intra-oral Views

Maxillary / upper Mandibular / lower occlusal

Positioning of flashes: move the flash closer to the lens

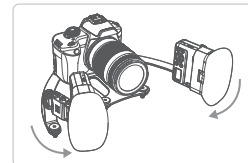

UR/UL
lingual



Positioning of flashes: move the flash closer to the lens

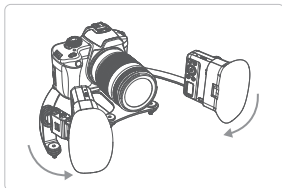

LR/LL
lingual



Positioning of flashes: move the flash further apart

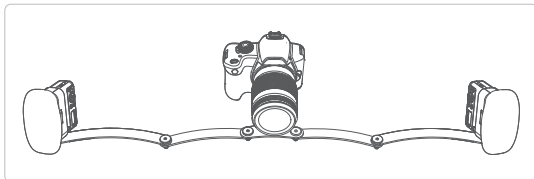

Maintenance

- Shut down the device immediately should abnormal operation be detected.
- Avoid sudden impacts and the product should be dedusted regularly.
- It is normal for the light beads to be warm when in use. Avoid continuous flashes if unnecessary.
- Maintenance of the light must be performed by our authorized maintenance department which can provide original accessories.
- This product, except consumables, is supported with a one-year warranty. Lithium battery is supported with six months warranty.
- Unauthorized service will void the warranty.
- If the product had failures or was wetted, do not use it until it is repaired by professionals.
- Changes made to the specifications or designs may not be reflected in this manual.

产品保修

尊敬的用户,本保修卡是申请维修服务的重要凭证,请您配合销售商填写并妥善保管,谢谢!

产品信息	型号	产品条码
用户信息	姓名	联系电话
	通信地址	
销售商信息	名称	
	联系电话	
	通信地址	
	销售日期	
备注		

注:此表应由销售商盖章确认。

产品信息

本文件适用于相关《产品保修信息》(见后面说明)所列产品,其他非属此范围的产品或部件(如促销品、赠品及其他出厂后附加的部件等)不在此保修承诺内。

保修期

产品及部件的相应保修期按相关的《产品保修信息》执行。保修期自产品首次购买日起算,购买日以购买产品时保修卡登记日期为准。

如何获得维修服务

您可直接与产品销售商或授权服务机构联系,也可拨打神牛产品服务电话,与我们联系,由我们的服务人员为您安排服务。申请保修时,您应提供有效的保修卡作为保修凭证,方可获得保修。如您不能提供有效的保修卡,则在我们确认产品或部件属于保修范围的情况下,也可以为您提供保修,但这不作为我们的义务。

不适用保修的情况

如产品存在下列情况, 本文件项下的保证和服务将不适用 ①产品或部件超过相应保修期; ②错误或不适当使用、维护或保管导致的故障或损坏, 如: 不当搬运; 非按产品合理预期用途使用; 不当插拔外接设备; 跌落或外力挤压; 接触或暴露于不适当温度、溶剂、酸碱、水浸或潮湿环境; ③由非神牛授权机构或人员安装、修理、更改、添加或拆卸造成的故障或损坏; ④产品或部件原有识别信息被修改变更或删除; ⑤无有效保修卡; ⑥使用非法授权、非标准或非公开发行的软件造成的故障或损坏; ⑦因不可抗力或意外事件造成的故障或损坏; ⑧其他非因产品本身质量问题导致的故障或损坏。遇上述情况, 您应向相关责任方寻求解决, 神牛对此不承担任何责任。因非在保修期或保修范围内的部件、附件或软件导致产品不能正常使用的, 不是保修范围内的故障。产品使用过程中正常的脱色, 磨损和消耗, 不是保修范围内的故障。

产品保修和服务支持信息

产品的保修期和服务类型按以下《产品保修信息》执行:

产品类别	选件名称	保修期(月)	保修服务类型
部件	电路板	12	客户送修
	电池	3	客户送修
	充电器、电源线, 同步线等带电性能的部件。	12	客户送修
其他	如闪光灯管、造型灯泡、外壳、保护罩、锁紧装置、包装等。	无	无保修

神牛产品售后服务电话 0755-29609320-8062

Warranty

Dear customers, as this warranty card is an important certificate to apply for our maintenance service, please fill in the following form in coordination with the seller and safe-keep it. Thank you!

Product Information	Model	Product Code Number
Customer Information	Name	Contact Number
	Address	
Seller Information	Name	
	Contact Number	
	Address	
	Date of Sale	
Note		

Note: This form shall be sealed by the seller.

Applicable Products

The document applies to the products listed on the Product Maintenance Information (see below for further information). Other products or accessories (e.g. promotional items, giveaways and additional accessories attached, etc.) are not included in this warranty scope.

Warranty Period

The warranty period of products and accessories is implemented according to the relevant Product Maintenance Information. The warranty period is calculated from the day(purchase date) when the product is bought for the first time, And the purchase date is considered as the date registered on the warranty card when buying the product.

How to Get the Maintenance Service

If maintenance service is needed, you can directly contact the product distributor or authorized service institutions. You can also contact the Godox after-sale service call and we will offer you service. When applying for maintenance service, you should provide valid warranty card. If you cannot provide valid warranty card, we may offer you maintenance service once confirmed that the product or accessory is involved in the maintenance scope, but that shall not be considered as our obligation.

Inapplicable Cases

The guarantee and service offered by this document are not applicable in the following cases: ①. The product or accessory has expired its warranty period; ②. Breakage or damage caused by inappropriate usage, maintenance or preservation, such as improper packing, improper usage, improper plugging in/out external equipment, falling off or squeezing by external force, contacting or exposing to the improper temperature, solvent, acid, base, flooding and damp environments, etc; ③. Breakage or damage caused by non-authorized institution or staff in the process of installation, maintenance, alternation, addition and detachment; ④. The original identifying information of product or accessory is modified, alternated, or removed; ⑤. No valid warranty card; ⑥. Breakage or damage caused by using illegally authorized, nonstandard or non-public released software; ⑦. Breakage or damage caused by force majeure or accident; ⑧. Breakage or damage that could not be attributed to the product itself. Once met these situations above, you should seek solutions from the related responsible parties and Godox assumes no responsibility. The damage caused by parts, accessories and software that beyond the warranty period or scope is not included in our maintenance scope. The normal discoloration, abrasion and consumption are not the breakage within the maintenance scope.

Maintenance and Service Support Information

The warranty period and service types of products are implemented according to the following Product Maintenance Information:

Product Type	Name	Maintenance Period(month)	Warranty Service Type
Parts	Circuit Board	12	Customer sends the product to designated site
	Battery	3	Customer sends the product to designated site
	Electrical parts e.g.battery charger, power cord, sync cable, etc.	12	Customer sends the product to designated site
Other Items	Flash tube, modeling lamp, lamp body, lamp cover, locking device, package, etc.	No	Without warranty

Godox After-sale Service Call 0755-29609320-8062